



SOMOGYI ELEKTRONIC®

2017

PRODUCT CATALOG



www.somogyi.hu

INNOVATION

PARTNER IN ELECTRONICS

since
1981

Dear Partner!

You are holding the product catalog for 2017 in your hand. We hope that this year we also managed to create a professional catalog full of technical information, which is easy to navigate and use.

Just like in 2016, this year we also marked the mutual success, innovation and growth as the primary goals.

Thanks to the confidence of our partners, our colleagues' competence and commitment of the owners, in the past year we presented nearly 500 new products in the market, based on your needs. It made us happy to see the increase of the turnover of our existing partners and of course the arrival of many new partnerships, which allowed more than 15% increase of the annual sales, thus fittingly we celebrated the 35th anniversary of our existence.

In 2017 also, our most important goal is the distribution of excellent price-value products, continuous renewal of our product portfolio, further improvement of the quality of fast and accurate services, thereby increasing customer satisfaction.

We are constantly expanding our supplier network to fit the needs of the market and to renew our range of product in innovative ways and to keep up with the trends of the market.

We continue to seek fair business relationships, which are based on trust and commitment.

We believe that the long-term mutual cooperation pays off for our customers, our employees, our suppliers and all who are associated with us.

We see our employees as the most important capital of our company. At the beginning of the year we strengthened our departments by recruiting new colleagues for faster and more efficient administration. Our colleagues are regularly trained so in all things and the sooner they can react and find a solution to your questions.

Thank you for taking time for our thoughts, we hope that the year ahead will be a similar success for all of us as it was in the last, and we can achieve our goals and experience the success with you!



Ujvári Márta
executive director



Somogyi Zsolt
owner - manager

RENEWED WEBSITE

In the past year, our website www.somogyi.hu renewed, which we have tried to create a clear, easy to use, pure online ordering interface to lead your orders quickly and easily.

The qualitative leap can be felt due to the product photos are displayed in larger size and high quality, simple filtration system parameters and product comparability. Use it and contact us with any questions with confidence!



INNOVATION

As in the previous year, in 2017 we also pursue to expand and develop our product range.

We continued to expand the range of our **power string/extension cord product family**, and we want to ensure the continuous stock availability.

The range of heating and cooling technology products is supplemented with several new devices.

Our aim is to create a more unified and more attractive packaging for our Christmas products.

We highly recommend the **HOME by Somogyi household appliances**, which are expanding with several new products during the year.

Our lighting products are complemented by a completely new decorative line (lanterns, light garlands, tea lights, laser lights), which we offer for events, weddings, party decorations and are available all year round.

We emphasize also to expand the range of our **SAL products**.

You can order a number of **new sound technology products** and accessories, whether for home or professional use.

During the year we will **renew our car multimedia assortment**: these will be much cheaper and with more knowledge than our old products.

Some of our new products will represent the SMART line due to the increasing demands, and more „smart“ products will appear in our offer.

Watch our for out specials and seasonal publications, which will promise lots of new features and discounts!

We wish to increase cooperation with our existing distribution partners (Honeywell, Silverline) and we are working to find new partners.

EVENTS

At our central site, in the fall of each year we organize **Somogyi Elektronik PROFESSIONAL DAY AND FAIR for nearly 15 years**, which we invite our key partners to, we present existing and new products, and give professional presentations to intrested parties.

In view of the great success, again this year we are planning a two-day event, later we will inform you about the date.

Please contact our colleagues responsible for sales for participation in the event and about more details!

Make sure that You can be there!



Household appliances

Sit back and start scrolling the catalog pages while drinking a steaming coffee or tea! At the beginning of our 2017 year catalog, you can find wide range of the new HOME by Somogyi household appliances. This product group will be improved continuously. First example is the new, stainless steel, 1,7 l electric kettle and the mini oven which is useful to prepare breakfast. Beside expanding kitchen appliances, we offer bathroom scale and kitchen scales, hair dryer and iron as well.



HG KV 06

Coffee maker

800
Watt

8

1l

- suitable for making 8 cups of coffee
- 1 litre water tank
- glass carafe with thermally insulated handle
- washable, plastic permanent filter
- usable with paper filter as well
- heating warming plate
- automatically closing valve by removing the carafe
- easy cleaning
- non-slip silicone soles
- overheating protection
- length of power cable: 75 cm
- size: 21 x 28,5 x 16 cm

HG KV 06/K

Glass carafe
for HG KV 06 coffee maker

- glass



HG KV 06/S

Coffee maker filter
for HG KV 06



HG VF 04 Electric kettle

2000
Watt

1,7 l

- 1,7 l water tank
- double-walled, stainless steel-plastic design
- liquid level can be seen from both sides
- drip-free pouring
- removable water filter
- 360° degree rotate able stand
- hidden heating element
- thermally insulated handle
- easy to clean
- overheating protection
- length of power cable: 65 cm
- size: Ø16 x 24 x 26 cm



HG VF 03 Electric kettle



1000
Watt

1,2
liter

- 1,2 l water tank
- liquid level can be seen from both sides
- drip-free pouring
- removable water filter
- 360° degree rotate able stand
- hidden heating element
- thermally insulated handle
- easy to clean
- overheating protection
- length of power cable: 75 cm
- size: Ø14,5 x 22,5 x 19 cm



HG MS 09 Mini oven

800
Watt

9 L



- ideal for baking hot sandwiches
- upper or lower baking can be used separately or together
- with max. 60 minutes timer
- thermally insulated handle
- double-walled, metal housing
- easy to clean crumb tray
- accessories: grill, tray and grip for removing tray
- length of power cable: 1,2 m
- size: 36 x 19,5 x 26 cm



HG KP 01 Toaster

750
Watt



- 2 slices of bread can be toasted at the same time
- toasting is adjustable in 7 stages
- STOP button to cancel toasting
- easy to clean crumb tray
- length of power cable: 85 cm
- size: 23 x 15,5 x 14,5 cm



HG SZ 02 Sandwich maker

750
Watt

**NON
STICK**

- two sandwiches can be prepared at the same time
- power lights/ready for grill light
- non-stick plates
- easy to clean
- power cable holder
- length of power cable: 85 cm
- size: 22 x 9,5 x 22 cm



HG GS 19 Waffle maker

750
Watt

**NON
STICK**

- two waffles can be prepared at the same time
- power lights/ready for baking light
- non-stick plates
- easy to clean
- length of power cable: 70 cm
- size: 23 x 8,5 x 23,5 cm



HG AP 13 Chopper

320
Watt

1L
GLASS

- stainless steel knives
- 1 liter glass bowl
- simple handle
- easy to clean
- overheating protection
- length of power cable: 100 cm
- noise level: 75 dB(A)
- size: 19 x 22 x 16 cm



HG BM 12 Hand blender

250
Watt

15.000/
min

- ergonomic grip
- stainless steel knives
- made of ABS
- high speed (15 000/ min)
- mixing shaft can be removed easily
- easy cleaning
- overheating protection
- length of power cable: 120 cm
- size: Ø6,5 x 35 cm



HG KM 17 Hand mixer

250
Watt

5 SPEED
levels

TURBO

- 5 speed levels
- TURBO speed level
- egg-beater and kneading hooks are included
- release button to disconnect the mixing shafts comfortably
- easy cleaning
- overheating protection
- length of power cable: 110 cm
- size: 20 x 15 x 10 cm

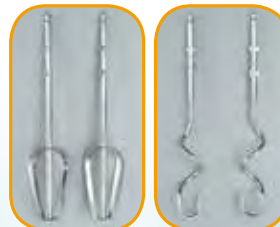

HG M 08 Kitchen scale

max.
5000 g
11 lb

tempered
GLASS

HIGH
precision

- measurement accuracy: 1 g/ 0.001 lb
- tare function
- selectable measuring units: kg, lb, oz
- automatic switch off
- display of battery status and overloading
- power supply: 1 x 3V (CR2032) button battery (included)
- size: 14 x 19,5 cm

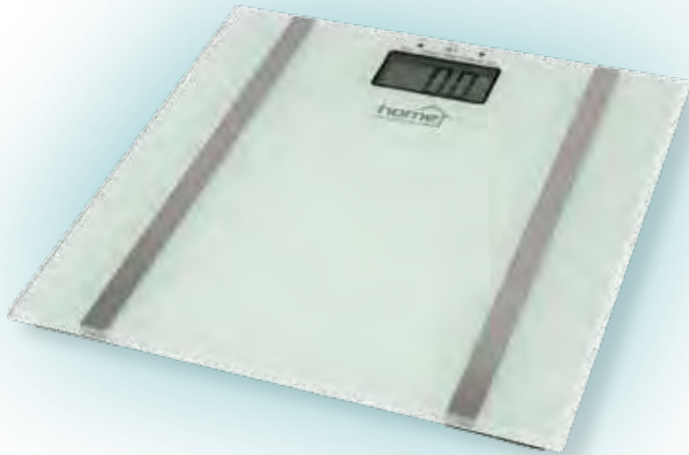

HG FMZ 10 Bathroom scale

tempered
GLASS

max.
150 kg
330 lb

10 user
memory

- measurement accuracy: 0,1 kg/ 0,1 lb
- measuring of body fat and body water percentage upon BMI principle
- automatic on/off switch
- display of battery status and overloading
- memory, storing data of 10 users
- selectable measuring units: kg, lb, st
- LCD display: 69 x 34 mm
- power supply: 1 x 3 V (CR2032) button battery (included)
- size: 30 x 30 cm

HG FM 10 Bathroom scale

tempered
GLASS

max.
150 kg
330 lb

- measurement accuracy: 0,1 kg/ 0,1 lb
- automatic on/off switch
- display of battery status and overloading
- LCD display: 69 x 34 mm
- power supply: 1 x 3 V (CR2032) button battery (included)
- size: 29 x 29 cm

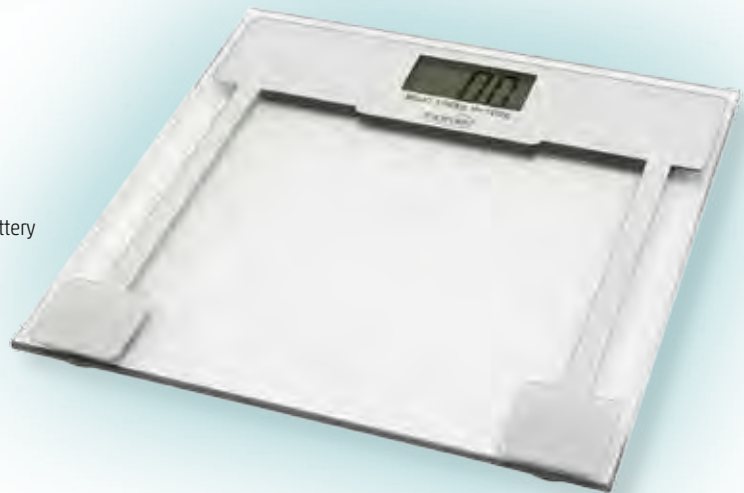

HG PM 09 Baggage scale

max.
44 kg
88 lb

kg / lb

- measurement accuracy: 0.1 kg/lb
- tare function
- measuring units: kg, lb
- automatic switch off
- display of battery status and overloading
- power supply: 1 x 3 V (CR2032) button battery (included)
- size: 10 x 3,5 x 3 cm



HG HSZ 17 Hair dryer

**1000
Watt**



- foldable handle
- hanging design
- two stages for efficient hair drying
- cold air function
- air concentrator
- length of power cable: 1,65 m
- size: 13 x 7 x 19 cm



hair dryer, iron

HGV 15 Steam iron

**1200
Watt**



- stainless steel soleplate
- self cleaning function
- steaming and vertical steam shot functions
- spray function
- heating indicator light
- flexible power cable connection
- 160 ml water tank
- length of power cable: 1,8 m
- size: 24 x 12 x 10 cm



The summer heat is becoming more cruel, leaving no choice year after year. Due to climate change there will be more and more need in the future for fans with different designs and functions. There are air coolers operating on the basis of natural cooling principle, professional, multifunctional humidifier fans can be found in our range, as well as simpler desk, standing or floor fans. Using of our air purifiers, you can significantly decrease the symptoms of allergy and asthma.

Get ready for the summer time!

Cooling technology

90
Watt



Mist fan



- 40 cm blade diameter
- touchscreen and remote control
- adjustable output (3 stages), natural wind and night mode
- separately switchable functions: humidifier, ionization, heated insect repeller compartment (for insect repellent mat)
- built-in water tank (3,1 l)
- humidifying is adjustable in 3 stages
- 12-hour fan shut down timer
- aroma storage compartment
- switchable oscillation (75°)
- acoustic power level $L_{WA} = 52,7 \text{ dB(A)}$
- length of power cable: 1,65 m
- power supply: 230 V~ / 50 Hz / 90 W
- size: $\varnothing 45 \times 40 \times 135 \text{ cm}$



SFM 42/SL

- silver



SFM 42/BK

- black



LH 300 Air cooler



Device is used in confined spaces to freshen or cool them. Due to its operation principle it is not suitable to significantly lower the temperature of rooms. It cools down the circulating air by evaporating cold water, so it provides a fresh comfortable feeling. The speed of airflow is adjusted by a fan in 3 speed levels, and its dispersion ensured by switchable blades.

- built-in water tank (3 l)
- accessory freezer packs
- replaceable evaporator mat (LH 300/T)
- adjustable ventilator output (3 stages)
- switchable air blades
- ergonomic carrying handle
- rolling on castors, lockable
- noise level $L_{WA} = 60$ dB (A)
- length of power cable: 1,5 m
- power supply: 230 V~ / 50 Hz / 80 W
- size: 25 x 58 x 28 cm

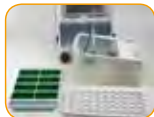

LH 300/T Evaporator mat for LH 300

TWFR 79 Tower fan with remote controller



- touch panel and remote controller
- 3 operation modes: normal, natural, sleep
- adjustable output (3 stages)
- 7,5-hours switch-off timer
- switchable oscillation (75°)
- noise level $L_{WA} = 56$ dB (A)
- length of power cable: 1,6 m
- power supply: 230 V~ / 50 Hz / 40 W
- size: Ø18 x 79 cm



TWFR 80 Tower fan with remote controller

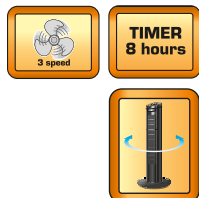

- adjustable output (3 stages)
- 8-hours switch-off timer
- switchable oscillation (75°)
- noise level $L_{WA} = 59$ dB (A)
- remote controller can be fixed magnetically on the top of the fan
- length of power cable: 1,6 m
- power supply: 230 V~ / 50 Hz / 55 W
- size: Ø15 x 80 cm



TWF 81 Tower fan



- rotary switch
- recessed carrying handle
- adjustable output (3 stages)
- switchable oscillation (75°)
- noise level $L_{WA} = 60$ dB (A)
- length of power cable: 1,5 m
- power supply: 230 V~ / 50 Hz / 45 W
- size: Ø22 x 80 cm



SFS 40

Standing metal fan



85°

90-120 cm

- 40 cm fan blade diameter
- adjustable height (90 - 120 cm)
- adjustable output (3 stages)
- switchable oscillation (85°)
- controllable dip angle of head (+/- 15°)
- metal blades
- noise level $L_{WA} = 63$ dB (A)
- length of power cable: 1,6 m
- power supply: 230 V~ / 50 Hz / 50 W
- size: 40 x 120 cm



SFI 45

Standing metal fan



- 45 cm fan blade diameter
- adjustable output (3 stages)
- adjustable height (108 - 143 cm)
- controllable dip angle of head (90°)
- metal blades
- dense grid
- noise level $L_{WA} = 70$ dB (A)
- length of power cable: 1,6 m
- power supply: 230 V~ / 50 Hz / 100 W
- size: 50 x 143 cm



SFP 40

Standing fan with remote controller



90°

100-130 cm

- 40 cm fan blade diameter
- adjustable output (3 stages)
- adjustable height (110 - 130 cm)
- switchable oscillation (90°)
- wind function (2 levels)
- timer (30 minutes - 7,5 hours)
- all functions are remote controllable
- noise level $L_{WA} = 70$ dB (A)
- length of power cable: 1,5 m
- remote controller power supply:
2 x AAA (1,5 V)
(not included)
- power supply:
230 V~ / 50 Hz /
45 W
- size:
40 x 130 cm



SF 41

Standing fan



85°

110-130 cm

- 40 cm fan blade diameter
- transparent blades
- adjustable height (110 - 130 cm)
- adjustable output (3 stages)
- switchable oscillation (85°)
- controllable dip angle of head (+/- 15°)
- noise level $L_{WA} = 67$ dB (A)
- length of power cable: 1,5 m
- power supply: 230 V~ / 50 Hz / 45 W
- size: 40 x 130 cm





TFS 30

Metal desk fan



- 30 cm fan blade diameter
- metal blades
- adjustable output (3 stages)
- switchable oscillation (85°)
- controllable dip angle of head (+/- 15°)
- noise level $L_{WA} = 58$ dB (A)
- length of power cable: 1,8 m
- power supply: 230 V~ / 50 Hz / 35 W
- size: 34 x 40 cm



TF 31

Desk fan



- blade diameter: 30 cm
- white blades
- adjustable output (3 stages)
- switchable oscillation (90°)
- controllable dip angle of head
- noise level $L_{WA} = 55$ dB (A)
- length of power cable: 1,45 m
- power supply: 230 V~ / 50 Hz / 40 W
- size: 34,5 x 47 cm



TF 23

Desk fan



- blade diameter: 23 cm
- white blades
- adjustable output (2 stages)
- switchable oscillation (90°)
- controllable dip angle of head
- noise level $L_{WA} = 51$ dB (A)
- length of power cable: 1,45 m
- power supply: 230 V~ / 50 Hz / 21 W
- size: 27 x 39 cm

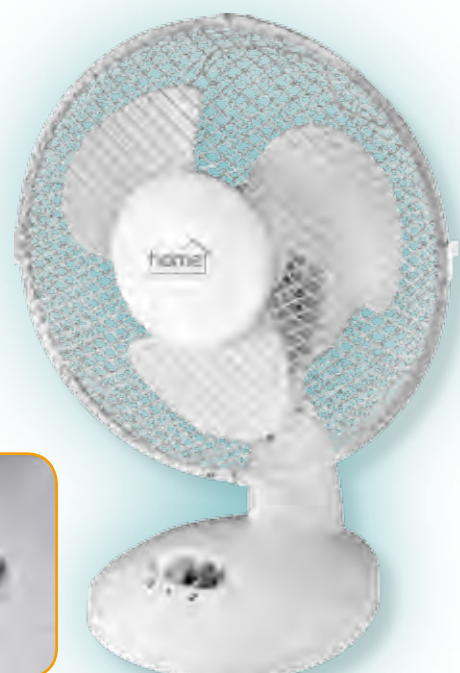

PVR 50

Floor fan



120 W

- blade diameter: 50 cm
- metal blades
- adjustable output (3 stages)
- controllable dip angle of head (90°)
- massive chrome plated protective grid
- noise level $L_{WA} = 70$ dB (A)
- length of power cable: 1,6 m
- power supply: 230 V~ / 50 Hz / 120 W
- size: 60 x 58 x 25 cm



PVR 45

Floor fan



100 W

- blade diameter: 45 cm
- metal blades
- adjustable output (3 stages)
- controllable dip angle of head (90°)
- massive chrome plated protective grid
- noise level $L_{WA} = 70$ dB (A)
- length of power cable: 1,8 m
- power supply: 230 V~ / 50 Hz / 100 W
- size: 57 x 54 x 22 cm

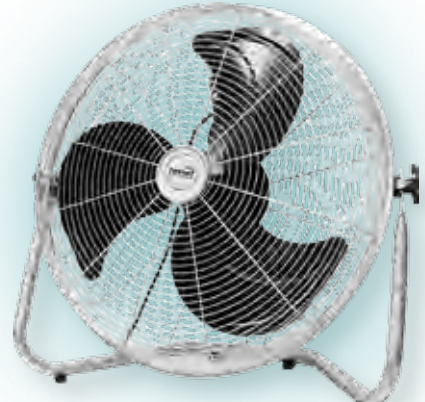

PVR 40

Floor fan



90 W

- blade diameter: 40 cm
- metal blades
- adjustable output (3 stages)
- controllable dip angle of head (90°)
- massive chrome plated protective grid
- noise level $L_{WA} = 68$ dB (A)
- length of power cable: 1,8 m
- power supply: 230 V~ / 50 Hz / 90 W
- size: 53 x 51 x 20 cm

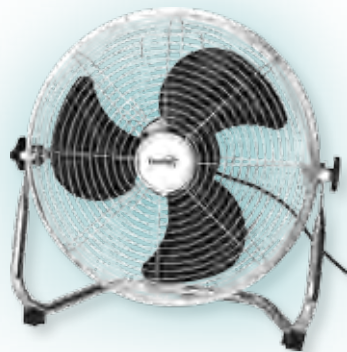

PVR 35

Floor fan



60 W

- blade diameter: 35 cm
- metal blades
- adjustable output (3 stages)
- controllable dip angle of head (90°)
- massive chrome plated protective grid
- noise level $L_{WA} = 70$ dB (A)
- length of power cable: 1,6 m
- power supply: 230 V~ / 50 Hz / 60 W
- size: 46 x 46 x 20 cm



EV 100/S

Air vent fan

- ideal for venting rooms, removing humidity and odours
- quiet operation: 33 dB
- big volume of air transmission: 100 m³/h
- small consumption: 15 W
- power supply: 230 V~ / 50 Hz
- size: inner part, sinking to the wall: 55 mm, Ø100 mm
outer part, outside the wall: 158 x 158 mm



EV 100/T

- with timer
- timer for switch off 1 - 20 minutes

EVZ 100/S

Air vent fan, lockable

- ideal for venting rooms, removing humidity and odours
- equipped with automatic shutters
- quiet operation: 33 dB
- big volume of air transmission: 100 m³/h
- small consumption: 15 W
- power supply: 230 V~ / 50 Hz
- size: inner part, sinking to the wall: 40 mm, Ø100 mm
outer part, outside the wall: 150 x 150 mm



EVZ 100/T

- with timer
- timer for switch off 1 - 20 minutes

EVZ 100/H

- with timer and humidity sensor
- timer for switch off 1 - 20 minutes
- humidity detection: 40-100%



DHM 18L Dehumidifier

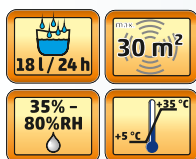

- dehumidifying capacity: 18 l / 24 h (30 °C, RH: 80%)
10 l / 24 h (27 °C, RH: 60%)
- recommended room size: 20 - 30 m²
- 4 operation modes (AUTO, QUIET, DRY, FAN)
- separately switchable ionization
- memory for last settings
- displaying actual relative humidity
- adjustable desired humidity (35 % - 80 % RH)
- 1 - 24 hour shutdown timer, adjustable per hour
- 3,0 l water tank, indication light for full tank
- included drain pipe (1 m) to be used optionally
- massive carrying handle
- easy to roll on its castors
- air delivery rate: 160 m³/h
- noise level: 45 dB(A)
- length of power cable: 1,6 m
- size of appliance: 320 x 560 x 220 mm



dehumidifier

DHM 10L Dehumidifier



- dehumidifying capacity: 10 l / 24 h (30 °C, RH: 80%)
5 l / 24 h (27 °C, RH: 60%)
- recommended room size: 10 - 20 m²
- 5 operation modes (Dehumidify, Automatic, Continuous, Fast Dry Clothes, Fan)
- memory for last settings
- displaying actual relative humidity
- adjustable desired humidity (30 % - 80 % RH)
- 1 - 24 hour shutdown timer, adjustable per hour
- 2,2 l water tank, indication light for full tank
- included drain pipe (30 cm) to be used optionally
- children's safety lock
- easy to roll on its castors
- air delivery rate: 120 m³/h
- noise level: 45 dB(A)
- length of power cable: 1,8 m
- size: 28,4 x 48 x 24 cm



DHM 700 Dehumidifier

DUAL VOLTAGE
AC 230 V~ /
DC 12 V==

CAPACITY
700
ml/day

WATER TANK
2 l

- It is a Peltier-based device, no compressor, no air conditioner gas. Consequently, the device is easy and operates quietly.
- dehumidification max. 700 ml/day (25 °C, 85% RH)
 - 2-liter water tank
 - switches off automatically when the water tank is full
 - easy, silent appliance
 - noise level: 40 dB (A)
 - two kinds of power supply: AC 230 V~ / 70 W
DC 12 V== / 52 W
 - length of power cable: 1,2 m
 - size: 24 x 36 x 14 cm



DHM 250 Dehumidifier

DC 9 V==

CAPACITY
250
ml/day

WATER TANK
500 ml

- It is a Peltier-based device, no compressor, no air conditioner gas. Consequently, the device is easy and operates quietly.
- dehumidification max. 250 ml/day (25 °C, 85% RH)
 - 0,5-liter water tank
 - switches off automatically when the water tank is full
 - accessory power adaptor
 - easy, compact, silent appliance
 - power output: 23 W
 - noise level: 40 dB(A)
 - length of power cable: 1,2 m
 - power supply: network adaptor PRI: 230 V~ / 50 Hz
• SEC: 9 V / 3 A
 - size: 15,4 x 22 x 13 cm



AIR 30 Air purifier

- 4-stage filtration system
- with built-in ionizer: released negative ion concentration 3×10^6 ions / cm^3
- low, medium and high fan speed
- 12-hour switch off timer
- recommended room size: 20-30 m^2
- with remote controller (CR2025 battery included)
- filter set is included (AIR 30/S)
- noise level: 55 dB (A)
- power supply : 230 V~ / 50 Hz / 40 W
- dimensions: 30,5 x 42,5 x 15 cm



AIR 20 Air purifier

- 4-stage filtration system
- with built-in ionizer: released negative ion concentration 3×10^6 ions / cm^3
- low, medium and high fan speed
- 8-hour switch off timer
- recommended room size: 10-20 m^2
- with remote controller (CR2025 battery included)
- filter set is included (AIR 20/S)
- cable storage compartment
- noise level: 48 dB (A)
- power supply : 230 V~ / 50 Hz / 40 W
- dimensions: 35 x 29,5 x 18 cm



AIR 30/S Filter set for AIR 30 appliance



AIR 20/S Filter set for AIR 20 appliance



Heating technology

With our range of heaters almost everyone will find suitable equipment to meet the heating needs, whether it's a frost guard, fireplace, traditional convection heater or fan heater. Our aim is to always meet the needs of our customers. So in our catalog there are several new heating products can be found. We improved our range of fireplaces, and everyone can find the ideal outdoor heater for themselves.



electric fireplace

FKK 08

Electric fireplace



2000 W



- white MDF board
 - 2 heating stages: 1000 W / 2000 W
 - heater with fan, blow out point at the bottom
 - separately useable, realistic glowing wooden log and flame effect
 - 2 x max. 25 W (230 V~ / 50 Hz / G9) halogen bulbs (included)
 - overheating protection
 - max power: 2050 W
 - length of power cable: 1,75 m
 - dimension: 109 x 100 x 37 cm
- The appliance is not suitable to illuminate household rooms.



FKK 09 Electric fireplace



2000 W



- white MDF board
 - stainless fireplace
 - 2 heating stages: 1000 W / 2000 W
 - heater with fan, blow out point at the top
 - built-in LED light source (5 W, not replaceable)
 - separately useable, realistic glowing coal and flame effect
 - overheating protection
 - max power: 2005 W
 - length of power cable (within the furniture + outside): 1,75 m (1 m + 0,75 m)
 - power supply: 230 V~ / 50 Hz
 - dimension: 77 x 72,5 x (25/17,5) cm
- The appliance is not suitable to illuminate household rooms.



electric fireplace



FKK 02 Electric fireplace, panorama



1800 W



- independently switchable flame effect with brightness control
 - fan heater, 2 heating stages (900 / 1800 W)
 - functions: cold-, warm-, hot air
 - thermostat control
 - overheating protection
 - bright source: 2 x 25 W traditional candle bulb
 - length of power cable: 1,6 m
 - power supply: 230 V~ / 50 Hz
 - size: 59,5 x 64 x 29 cm
- The appliance is not suitable to illuminate household rooms.



FKK 05 Electric fireplace



2000 W



- 2 heating stages: 1000 / 2000 W
 - heater with fan, blow out point at the bottom
 - built-in LED light source (10 W, not replaceable)
 - independently switchable flame effect
 - overheating protection
 - maximum output: 2010 W
 - length of power cable: 1,6 m
 - power supply: 230 V~ / 50 Hz
 - size: 39,5 x 56,5 x 23 cm
- The appliance is not suitable to illuminate household rooms.



FKK 06 Electric, wall-mounted fireplace, arched



2000 W



- individually switchable flame-effect with adjustable brightness
 - tempered glass front panel
 - built-in energy saving LED light source (10 W)
 - 2 heating stages: 1000 W / 2000 W
 - blow out point at the top
 - all functions are remote-controllable
 - remote controller power supply: 2 x AAA battery (not included)
 - overheating protection
 - maximum output: 2010 W
 - length of power cable: 1,75 m
 - power supply: 230 V~ / 50 Hz
 - size: 88,5 x 56 x 13,5 cm
- The appliance is not suitable to illuminate household rooms.



FKK 2000 Electric, wall-mounted fireplace



2000 W



- individually switchable flame-effect with adjustable brightness
 - fan heater, 2 heating stages (1000 / 2000 W)
 - all functions are remote-controllable
 - tempered glass / wooden / plastic front panel
 - overheating protection
 - built-in, energy saving LED light source (10 W)
 - remote controller power supply: 2 x AAA battery (not included)
 - length of power cable: 1,7 m
 - power supply: 230 V~ / 50 Hz
 - size: 90 x 56 x 11 cm
- The appliance is not suitable to illuminate household rooms.



	FKK 08	FKK 09	FKK 02	FKK 05	FKK 06	FKK 2000
placement	standing	standing	standing	standing	wall-mounted	wall-mounted
heating stages	1000 / 2000 W	1000 / 2000 W	900 / 1800 W	1000 / 2000 W	1000 / 2000 W	1000 / 2000 W
fan	yes	yes	yes	yes	yes	yes
light effect stages	no	no	continuously adjustable	no	5	5
light source	2 x 25 W halogen bulb, (G9)	LED (5W)	2 x 25 W candle bulb, (E14)	LED (10 W)	LED (10 W)	LED (10 W)
thermostat	no	no	yes	no	no	no
material	MDF furniture panel	MDF furniture panel, stainless steel fireplace	MDF, glass	plastic	tempered glass	tempered plate glass, wood, plastic
noise level	50 dB(A)	50 dB(A)	48 dB(A)	50 dB(A)	50 dB(A)	48 dB(A)
length of power cable	1,75 m	1,75 m	1,6 m	1,6 m	1,75 m	1,75 m
remote controller	no	no	no	no	yes	yes
remote controller power supply	-	-	-	-	2 x AAA (not included)	2 x AAA (not included)
size	109 x 100 x 37 cm	77 x 72,5 x (25/17,5) cm	59,5 x 64 x 29 cm	39,5 x 56,5 x 23 cm	88,5 x 13,5 x 56 cm	90 x 56 x 11 cm
weight	45 kg	15 kg	22,1 kg	5,2 kg	18,1 kg	16 kg

FKF 2200 LCD

Wall-mounted heater with LCD display



2200 W

- adjustable heating stages (1100 W / 2200 W)
- all functions are remote-controllable
- functions: cold-, warm-, hot air
- continuous ionisation
- adjustable oscillation
- 7,5 hour timer
- built-in thermostat
- overheating protection
- power supply: 230 V~ / 50 Hz
- size: 69 x 28,5 x 18 cm



wall-mounted heater



FKF 2000 LCD

Wall-mounted heater with LCD display



2000 W

- safe PTC heating element
- adjustable heating stages (1000 / 2000 W)
- all functions are remote-controllable
- functions: cold-, warm-, hot air
- adjustable oscillation
- 8 hour timer
- LCD display
- built-in thermostat
- stop program fan
- overheating protection
- remote controller power supply: 2 x AAA battery (not included)
- length of power cable: 1,45 m
- power supply: 230 V~ / 50 Hz
- size: 58 x 20 x 13 cm



FKF 2000 LED

Wall-mounted heater with LED display



2000 W

- safe PTC heating element
- adjustable heating stages (1000 / 2000 W)
- all functions are remote-controllable
- functions: cold-, warm-, hot air
- 7,5 hour timer
- LED indicator
- overheating protection
- remote controller power supply: 1 x CR2025 battery, included
- length of power cable: 1,6 m
- power supply: 230 V~ / 50 Hz
- size: 45 x 18,5 x 11,5 cm



FKF 2000B LCD

Wall-mounted heater with LCD display



2000 W



- safe PTC heating element
- adjustable heating stages (1000 / 2000 W)
- all functions are remote-controllable
- functions: cold-, warm-, hot air
- 8 hour timer
- LCD display
- built-in thermostat
- overheating protection
- remote controller power supply: 1 x CR2025 battery, included
- length of power cable: 1,6 m
- power supply: 230 V~ / 50 Hz
- size: 52 x 20 x 12,5 cm



FKF 2000D LCD

Wall-mounted heater with LCD display



2000 W



- 2 heating levels: 1000 / 2000 W
- maximum performance: 2000 W
- cold-, warm-, hot air
- swing air flow blades
- hourly adjustable 8 hour timer
- built-in thermostat
- overheating protection
- length of power cable: 1,5 m
- all functions are remote-controllable
- remote controller power supply: 2 x AAA battery (not included)
- power supply: 230 V~ / 50 Hz
- size: 55 x 18 x 12 cm



	FKF 2200 LCD	FKF 2000 LCD	FKF 2000B LCD	FKF 2000 LED	FKF 2000D LCD
placement	wall-mounted	wall-mounted	wall-mounted	wall-mounted	wall-mounted
heating stages	1100 / 2200 W	1000 / 2000 W	1000 / 2000 W	1000 / 2000 W	1000 / 2000 W
turn OFF timer	7,5 h	8 h	8 h	7,5 h	8 h
ventilator mode only	yes	yes	yes	yes	yes
ionisation	yes	no	no	no	no
swing	yes	yes	no	no	yes
thermostat	yes	yes	yes	no	yes
noise level	52 dB(A)	52 dB(A)	52 dB(A)	52 dB(A)	60 dB(A)
length of power cable	1,4 m	1,45 m	1,6 m	1,6 m	1,5 m
remote controller	yes	yes	yes	yes	yes
remote controller power supply	CR 2025 (included)	2 x AAA (not included)	CR 2025 (included)	CR 2025 (included)	2 x AAA (not included)
size	69 x 28,5 x 18 cm	58 x 20 x 13 cm	52 x 20 x 12,5 cm	45 x 18,5 x 11,5 cm	55,5 x 18 x 12 cm
weight	3,3 kg	3,1 kg	2,9 kg	1,7 kg	2,4 kg

FK 28

Ceramic heater with LCD display



2000 W



- with blue coloured display and remote controller
- control panel with touch buttons
- 2 heating levels: 1000 / 2000 W
- maximum output: 2000 W
- functions: cold-, warm-, hot air
- optional thermostat control
- 7,5 hour turn OFF timer, adjustable in 0,5 h increments
- switchable oscillation 75°
- overheating protection
- tip-over protection
- remote controller power supply: 1xCR2025 button battery (included)
- length of power cable: 1,35 m
- size: Ø26 x 16 x76 cm



FK 12

Ceramic heater



2000 W



- adjustable heating stages (1000 / 2000 W)
- functions: cold-, warm-, hot air
- switchable oscillation
- tip-over and overheating protection
- built-in mechanic thermostat
- power supply: 230 V~ / 50 Hz
- size: 24 x 30 x 16 cm



FK 11

Ceramic heater



1500 W

- adjustable heating stages (750 / 1500 W)
- functions: cold-, warm-, hot air
- switchable oscillation
- tip-over and overheating protection
- built-in mechanic thermostat
- power supply: 230 V~ / 50 Hz
- size: 20 x 29 x 16 cm



FK 30

Portable fan heater

2000 W

- safe PTC heating element
- 2 heating levels: 1000 / 2000 W
- functions: cold or hot air
- thermostat control
- strong metal housing, plastic carrying handle
- overheating protection
- power supply: 230 V~ / 50 Hz
- size: 19,5 x 31 x 22,5 cm



FK 31

Portable fan heater



2000 W

- IPX4 protection against splashing water
- strong, double-walled powder-coated metal housing
- functions: cold-, warm-, hot air
- 2 heating levels: 1000 W / 2000 W
- thermostat control
- overheating protection
- plastic carrying handle
- power supply: 230 V~ / 50 Hz
- size: 19,5 x 31 x 22,5 cm



FK 26

Wall-mounted bathroom heater



2000 W

- 2 heating levels: 1000 / 2000 W
- maximum output without consol: 2000 W
- maximum output with consol: 1000 W
- cold-, warm-, hot air
- thermostat control
- IPX1 protected against vertically dripping water
- overheating protection
- length of power cable: 1,5 m
- size: with holder: 37 x 69 x 11,5 cm,
without holder: 31 x 41,5 x 11,5cm



FK 24

Quarz tube heater



1200 W

- recommended to use in bathrooms
- 2 heating levels: 600 / max. 1200 W
- IPX4 protected against splashing water
- with cord switch
- can be wall-mounted
- strong metal housing
- adjustable tilt
- option: FK 24/T tube
- power supply: 230 V~ / 50 Hz
- size: 53,5 x 13 x 11 cm



FKC 901

Carbon fibre heater



- can be set on table
- 2 heating levels: 450 / 900 W
- high infrared radiation rate
- 90° rotatable head
- switchable oscillation (60°)
- silent operation
- switches off automatically when tipped over
- length of power cable: 1,4 m
- power supply: 230 V~ / 50 Hz
- size: with horizontal header: 33 x 75 x 33 cm, with vertical header: 64,5 x 53 x 33 cm

900 W



FKC 900

Carbon fiber heater



- 2 heating levels: 450 / 900 W
- high infrared radiation rate
- IPX4 protected against splashing water
- switchable oscillation (60°)
- silent operation
- turns off automatically when tipped over
- power supply: 230 V~ / 50 Hz
- size: Ø27 x 82 cm

900 W



FK 27

Halogen outdoor heater

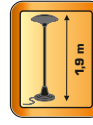

- 2 heating levels: 1500 / 3000 W
- high heat radiation rate
- IPX4 protection against splash water
- ideal for heating the terrace
- switches off automatically when tipped over
- silent operation
- stainless mounting
- weight: 12 kg
- length of power cable: 1,7 m
- power supply: 230 V~ / 50 Hz
- size: 60 x 190 x 46 cm

3000 W



IN 26145

Standing heater



1200 W

SILVERLINE®



- Silverline Greener Patio Heater 1200 TW Digital IPX4™
- touch switchable and remote controllable
 - 2 heating levels: 600 / 1200 W
 - 2 heating systems: halogen and carbon fiber heater
 - S-WAVE™ halogen, and C-WAVE™ carbon fiber heater
 - switchable oscillation
 - turn off timer, max. 6 hours
 - can be used outdoors, IPX4 protection
 - to heat up max. 14 m²
 - power supply: 230 V~ / 50 Hz
 - size: 87 cm

IN 26151

Standing heater



900 W

SILVERLINE®

- Silverline Greener Patio Heater 900 IPX4™
- with rotary switch
 - 2 heating levels: 450 / 900 W
 - C-WAVE™ carbon fibre technology, high infrared radiation rate
 - switchable oscillation
 - can be used outdoors, IPX4 protection
 - to heat up max. 10 m²
 - power supply: 230 V~ / 50 Hz
 - size: 87 cm



IN 26106

Wall-mounted heater



1200 W

SILVERLINE®

- Silverline Greener Patio Heater 1200 Wall IPX4™
- with cord switch, 2 heating levels: 600 / 1200 W
 - can be used outdoors, IPX4 protection
 - to heat up max. 10 m²
 - C-WAVE™ carbon fibre technology, high infrared radiation rate
 - power supply: 230 V~ / 50 Hz
 - size: 75 cm wide



Wall-mounted and standing heater

FK 23 Halogen heater



1200 W

- 3 heating levels: 400 / 800 / 1200 W
- maximum output: 1200 W
- individually switchable heating elements
- switchable oscillation
- turns off automatically when tipped over
- type of heating element: FK 23/T (163 mm, 400 W)
- length of power cable: 1,25 m
- size: 30 x 70 x 30 cm



FK 21 Halogen heater



1200 W

- 3 heating levels: 400 / 800 / 1200 W
- maximum output: 1200 W
- individually switchable heating elements
- switchable oscillation
- turns off automatically when tipped over
- type of heating element: FK 21/T (195 mm, 400 W)
- length of power cable: 1,1 m
- size: 36 x 52 x 26 cm



FK 15 Halogen heater

800 W

- adjustable heating stages (400 W / 800 W)
- string metallic housing
- turns off automatically when tipped over
- with cable holder
- option: FK 15/T heating element
- power supply: 230 V~ / 50 Hz
- size: 36 x 33 x 16 cm



Heating element



type	recommended to	size	output
FK 15/T	FK 15	25 cm	400 W
FK 21/T	FK 21	19,5 cm	400 W
FK 23/T	FK 23	16,3 cm	400 W
FK 24/T	FK 24	42 cm	600 W, IPX4
FKT 22CM	FK 16	22 cm	400 W
FKT 24CM	FK 6/K	24 cm	400 W
FKT 42CM	FK 2 and FK 22	42 cm	600 W
FKT 44CM	-	44 cm	600 W

FK 35/BK

Convection heater



1500 W

- tempered glass front panel
- adjustable heating stages
- 750 W / 1500 W
- max. output: 1500 W
- thermostat control
- free standing or wall-mounted
- turns off automatically when tipped over
- length of power cable: 1,5 m
- size: wall-mounted: 60 x 46 x 11,5 cm
- standing: 60 x 50 x 24 cm



FK 19 TURBO

Convection heater with fan



2000 W

- specially designed stage switch and thermostat control
- free standing or wall-mounted
- individually switchable turbo fan function
- 2 heating levels: 800 W / 2000 W
- heating operation indicator light in the rotary switch
- overheating protection
- power supply: 230 V~ / 50 Hz
- size: 68 x 46,5 x 19 cm



FK 13/2000

Convection heater



2000 W

- IPX4 protected against splashing water
- free standing, rollable, or wall-mountable
- aluminium heating element
- 2 heating levels: 1000 W / 2000 W
- thermostat control
- overheating protection
- power supply: 230 V~ / 50 Hz
- size: 78 x 51 x 25 cm



FK 34 Turbo convection heater



2000 W

- free standing or wall-mounted
- individually switchable turbo fan function
- 3 heating levels: 750 W / 1250 W / 2000 W
- heating mode indicator light
- thermostat control
- overheating protection
- length of power cable: 1,60 m
- size: wall-mounted: 69 x 41 x 15 cm
free standing: 69 x 45 x 20 cm



convection heater



FK 33 Convection heater

2000 W

- adjustable heating stages
- 750 W / 1250 W / 2000 W
- max. output: 2000 W
- thermostat control
- free standing or wall-mounted
- turns off automatically when tipped over
- length of power cable: 1,6 m
- size: wall-mounted: 53 x 33,5 x 13,5 cm
free standing: 53 x 38 x 20 cm



FKM 400 Wall-mounted heater, frost guard

450 W

- convection heater
- functions: heating - frost proofing
- overheating protection
- built-in mechanic thermostat
- heating mode indicating light
- power supply: 230 V~ / 50 Hz
- size: 27 x 25 x 11 cm



FK 37/BL

Fan heater

- blue / white

2000 W

- adjustable heating stages: 1000 W / 2000 W
- built-in mechanic thermostat
- functions: cold-, warm-, hot air
- overheating protection
- turns off when tipped over
- length of power cable: 1,2 m
- size: 26 x 24 x 13 cm



FK 37/GY

- grey / white

FK 37/RD

- red / white

FK 37/T

- turquoise / white



FK 1/O

Fan heater



2000 W

- adjustable heating stages: 1000 W / 2000 W
- built-in mechanic thermostat
- functions: cold-, warm-, hot air
- overheating protection
- switchable oscillation
- power supply: 230 V~ / 50 Hz
- size: 22 x 30 x 18 cm

FK 1

Fan heater

2000 W

- adjustable heating stages: 1000 W / 2000 W
- built-in mechanic thermostat
- turns off when tipped over
- functions: cold-, warm-, hot air
- overheating protection
- power supply: 230 V~ / 50 Hz
- size: 21 x 26,5 x 11 cm



FKO 11/BK

Oil radiator

2500 W

- 3 heating levels (1000/1500/2500 W)
- max. output: 2500 W
- thermostat control
- overheating and tip-over protection
- operating indicator light
- individually pressure tested
- rolling on castors
- fold-out carrying handle
- cable holder
- length of power cable: 1,55 m
- weight: 13,3 kg
- size: 24 x 63 x 51 cm



FKO 9/BK

Oil radiator

2000 W

- 3 heating levels (800/1200/2000 W)
- max. output: 2000 W
- thermostat control
- overheating and tip-over protection
- operating indicator light
- individually pressure tested
- rolling on castors
- fold-out carrying handle
- cable holder
- length of power cable: 1,55 m
- weight: 10,7 kg
- size: 24 x 63 x 43 cm



FKO 11/T

Oil radiator with built-in fan heater

2400 W

- 11 fins
- 3 oil radiator heating levels: 800 W, 1200 W, max. 2000 W
- individually switchable fan PTC heater (max. 400 W)
- thermostat control
- overheating protection
- power supply: 230 V~ / 50 Hz
- size: 16 (24) x 65,5 x 52,5 cm



	FKO 11/BK	FKO 9/BK	FKO 11/T	FKOS 13	FKOS 11	FKOS 9	FKOS 7
heating levels	1000 / 1500 / 2000 W	800 / 1200 / 2000 W	400 / 800 / 1200 / 2000 W	1000 / 1500 / 2500 W	800 / 1200 / 2000 W	600 / 900 / 1500 W	600 / 900 / 1500 W
fins	11	9	11	13	11	9	7
thermostat	yes	yes	yes	yes	yes	yes	yes
built-in fan	no	no	yes	no	no	no	no
other information			individually switchable ceramic PTC heater (max. 400 W)				
tip-over protection	yes	yes	yes	yes	yes	yes	yes
noise level			55 dB(A)				
length of power cable	1,55 m	1,55 m	1,4 m	1,5 m	1,5 m	1,5 m	1,5 m
size	24 x 63 x 51 cm	24 x 63 x 43 cm	16 (24) x 65,5 x 52,5 cm	12,5 (24) x 60 x 59 cm	12,5 (24) x 60 x 52 cm	12,5 (24) x 60 x 45 cm	12,5 (24) x 60 x 38 cm
weight	13,3 kg	10,7 kg	11,2 kg	11,5 kg	10 kg	8,5 kg	7 kg

FKOS 13 Oil radiator

2500 W



- 13 fins
- thermostat control
- 3 heating levels (1000 W / 1500 W / 2500 W)
- turns off automatically when tipped over or overheated
- individually pressure tested
- rolling on castors
- recessed carrying handle
- cable holder
- power supply: 230 V~ / 50 Hz
- size: 12,5 (24) x 60 x 59 cm

FKOS 11 Oil radiator

2000 W



- 11 fins
- thermostat control
- 3 heating levels (800 W / 1200 W / 2000 W)
- turns off automatically when tipped over or overheated
- individually pressure tested
- rolling on castors
- recessed carrying handle
- cable holder
- power supply: 230 V~ / 50 Hz
- size: 12,5 (24) x 60 x 52 cm

FKOS 9 Oil radiator

1500 W



- 9 fins
- thermostat control
- 3 heating levels (600 W / 900 W / 1500 W)
- turns off automatically when tipped over or overheated
- individually pressure tested
- rolling on castors
- recessed carrying handle
- cable holder
- power supply: 230 V~ / 50 Hz
- size: 12,5 (24) x 60 x 45 cm

FKOS 7 Oil radiator

1500 W



- 7 fins
- thermostat control
- 3 heating levels (600 W / 900 W / 1500 W)
- turns off automatically when tipped over or overheated
- individually pressure tested
- rolling on castors
- recessed carrying handle
- cable holder
- power supply: 230 V~ / 50 Hz
- size: 12,5 (24) x 60 x 38 cm

FHP 1200 Ash collector vacuum

18
liters

1200 W

- suitable for collecting cool ash (max. 50 °C), small wooden pieces and leafes
- 18 L metal bin
- washable filter (FHP 1200/S)
- metal hose (FHP 1200/G) Ø3,8 x 100 cm
- aluminium wand (FHP 1200/A) Ø3,8 x 23 cm
- power supply: 230 V~ / 50 Hz
- size: 34,5 x 34,5 x 45 cm



FHP 1200/S

Washable filter for FHP 1200 ash collector vacuum



- size: Ø16 x 9 cm

FHP 1200/G

Metal hose for FHP 1200 ash collector vacuum



- size: Ø3,8 x 100 cm

FHP 1200/A

Aluminium wand for FHP 1200 ash collector vacuum



- size: Ø3,8 x 23 cm

ATC928WIFI evohome Wi-Fi zone manager

Honeywell

The multi-zone evohome Wi-Fi zone manager can manage the maximum of 12 zone destinations, and - as needed- to regulate the temperature time program of (one) household hot water supply. All zones has got independent time and temperature control. The color display of the device has got background lighting. Beside providing external power supply, the device can be placed into a wall-mounted holder (ATF600), or desktop holder (ATF800). For remote access, the zone manager has to be connected to the existing router with the household Wi-Fi connection. Thereafter the programming and the heating control is accessible with smart phones and tablets by using internet connection. It is not necessary to use GATEWAY for this product. Compatibility: ANDROID4.1, iOS7.0 or advanced types.

- measurement 0,1 °C, displays every 0,5 °C
- 868 MHz
- 30 m range in open space
- power supply: 2 x NiMH accumulator, included
- the optional desktop or wall-mounted battery case ensures the battery charge
- size: 135 x 93 x 22 mm



ATF600 Wall mounting kit

Honeywell

Wall mounting kit for evohome Wi-Fi zone manager. With this device the evohome Wi-Fi zone manager can be wall-mounted (ATC928WIFI), and also supplies the charging of the accumulators. To install the holder, a standard, round mounted box is required where the power supply elements can be connected to the voltage and it can be hidden below the plane of the wall. - size: 85 x 105 mm



ATF800 Table stand

Honeywell

Table stand for evohome Wi-Fi zone manager. The table stand supplies the charging of the accumulators. The power is supplied by the mains socket which must be connected with the provided power cable. The zone manager can be placed anywhere in the house. - size: 105 x 60 x 100 mm



*radiator hidden by a curtain or cover

Y87RFC2074

Internet smart thermostat package

Honeywell



With T87 smart thermostat, BDR switch module and GATEWAY internet network module.
The device is easy to set up and has a large display. The thermostat can be connected to the boilers BDR module with using wireless connection. The GATEWAY internet network module also can be used with wireless connection which allows to create heating time programme which is also becomes accessible by using smart phones or tablets.
Compatibility: ANDROID4.1, iOS7.0 or advanced types.

- display with background light and rotatable switch frame (Ø83 mm)
- measurement 0,1 °C, displays per 0,5 °C
- 868 MHz
- 30 m range in open space
- power supply: 2 x AA (LR6) alkaline batteries, included
- the BDR relay units and the GATEWAY needs 230 V power supply
- Honeywell Total Connect Hungarian application



T87

Wireless smart thermostat

Honeywell

The thermostat is easy to set up and has got large display with background light and rotatable switch frame (Ø83 mm).
The thermostat can be connected to the BDR relay module and to the R88 Opentherm boiler control by using wireless connection.
The GATEWAY internet network module also can be used with wireless connection which allows to create heating time programme which is also becomes accessible by using smart phones or tablets.
The BDR relay module and the GATEWAY module can be connected with 2 thermostats, which allows the user to create bizonal heating control systems when there are 2 independent heating circuits in the house.
Compatibility: ANDROID4.1, iOS7.0 or advanced types.

- measuring per 0,1 °C, displays per 0,5 °C
- 868 MHz
- 30 m range in open space
- power supply: 2 x AA (LR6) alkaline batteries, included
- size: Ø85 x 35 mm

DTS

Digital room-temperature sensor

Honeywell

The DTS wireless room-temperature sensor provides information regarding to each rooms temperature to the evohome or evohome Wi-Fi zone manager. The desired room temperature can be also set up individually with each rooms temperature sensor. Can be used as a remote sensor of the HR92 radiator controller, e.g. where radiators are covered with curtains or where the radiators are hidden. *

- data transfer to the central unit every 4 minutes
- measuring per 0,1 °C, displays per 0,5 °C
- 868 MHz
- 30 m range in open space
- power supply: 2 x AA (LR6) alkaline batteries, included
- size: 90 x 90 x 26 mm



HR92 Wireless radiator thermostat

Honeywell

Intelligent radiator valves can be operated. The radiator controllers are using two-way communication with the evohome or evohome Wi-Fi (ATC928WIFI) zone manager in order to keep the desired temperature in each room, meanwhile every radiator can turn the boiler on if necessary. These stylish, ergonomically designed radiator controllers can fit to the standard thermostatic radiator valves and are easily applicable. The package includes the adapters to the most common radiator valves (Herz, Danfoss). If the radiator valves are hidden or covered, an individual room-temperature sensor (DTS) may be needed.

- large, tiltable display with background light
- window-opening sensing function
- protection against valve-stick
- data transfer to the central unit every 4 minutes
- measuring per 0,1 °C, displays per 0,5 °C
- 868 MHz
- 30 m range in open space
- valve connections: M30x1,5
- power supply: 2 x AA (LR6) lithium batteries, included
- IP30
- size: Ø55 x 100 mm



BDR Wireless switch module

Honeywell

A motorised zone valve or a boiler can be connected to the switch module (e.g. with the previously used thermostate cables). It ensures a wireless mounting surface between the devices and the T87 smart thermostat, the evohome or evohome Wi-Fi zone manager systems. The relay unit requires a constant 230 V connection.

- size: 91 x 90 x 30 mm



**GATEWAY
RFG100**

Honeywell

Internet network module

Internet network module for evohome zone manager and T87 wireless smart thermostat. The evohome zone manager and T87 smart thermostat can be reached via internet using smart phone or tablet. The GATEWAY internet network module can be connected to the router with the UTP cable, which is included to the package. The network interface is connecting wirelessly to the room thermostat, so it can be placed up to 30 m away from the thermostat. This device is not necessary to the evohome Wi-Fi central unit. The power is supplied by power mains socket.

- size: 125 x 152 x 62 mm



CMT727D1016 Wireless room thermostat

Honeywell

- Thermostat/programming unit*
- wireless connection (868 MHz) between the thermostat and the switch
 - the thermostat should be placed in the room where you want the thermostat to control the heating by detecting the room temperature
 - 7 days of programming
 - max. 4 time and temperature recording daily
 - multiple switching units can be paired with the room unit
 - built-in frost guard function (5 °C)
 - power supply: 2 x 1,5 V (AA) batteries, included
- Switch unit (relay)*
- can be wall mounted or placed into a wiring box
 - power supply: 230 V~ / 50 Hz
 - switch relay: 24...230 V~ / 10 A rez. / 3 A ind.
 - size: 135 x 95 x 21 mm
 - switch module: 90 x 90 x 30 mm



CMT707A1011 Programmable room thermostat

Honeywell

- 7 days of programming
- max. 4 time and temperature recording daily
- automatic winter/summer time change
- built-in memory for the programmes
- extra functions: holiday
- built-in frost guard function (5°C)
- switch relay: 24...230 V~ / 10 A rez. / 3 A ind.
- power supply; thermostat unit: 2 x 1,5 V (AA) battery, included
- power supply; switch unit 230 V~ / 50 Hz
- size: 135 x 95 x 21 mm



DT90A1008 Digital room thermostat

Honeywell

- selectable heating / cooling operation
- 5 °C ... 35 °C basic signal range per 0,5 °C
- advanced self-learning technology: adapts to the environment and ensures the accurate temperature control
- sensor error - self diagnosis
- 2-wired installation
- 8 A resistive, 3 A inductive capacity
- can be wall mounted or placed into a wiring box
- low battery charge notice
- power supply: 2 db AA (LR6) alkaline battery, included
- size: 90 x 90 x 28 mm



T6360A1079 Mechanic room thermostat

Honeywell

- temperature basic signal range: 10 ... 30 °C
- fixed switching hysteresis: 1 °C
- temperature element: gas-filled
- heating/cooling application
- power supply: 230 V~ / 50 Hz
- size: 83 x 83 x 40 mm



XC100D-HU

Carbon monoxide alarm

Honeywell

- meets EN 50291-1 standards
- electrochemical sensor
- alarm memory, event logging
- low gas concentration measurement mode: CO-sensor testing!
- life end notice
- self-test: every 60 minutes
- can be installed in bathrooms (IP44)
- built-in accumulator: 3 V, lithium
- operating temperature: -10 °C- +45 °C
- allowed humidity: 25-95%
- life time and warranty: 10 years
- LED indicators: power supply, fault, airing
- large alarm message
- informing LCD display
- size: 100 x 72 x 36 mm



XC100D-SK
Can be purchased only in Slovakia!

XC100-HU

Carbon monoxide alarm

Honeywell

- meets EN 50291-1 standards
- electrochemical sensor
- alarm memory, event logging
- low gas concentration measurement mode: CO-sensor testing!
- life end notice
- self-test: every 60 minutes
- can be installed in bathrooms (IP44)
- built-in accumulator: 3 V, lithium
- operating temperature: -10 °C- +45 °C
- allowed humidity: 25-95%
- life time and warranty: 10 years
- LED indicators: power supply, fault, airing
- large alarm message
- size: 100 x 72 x 36 mm

XC70-HU

Carbon monoxide alarm

Honeywell

- meets EN 50291-1 standards
- electrochemical sensor
- alarm memory, event logging
- low gas concentration measurement mode: CO-sensor testing!
- life end notice
- self-test: every 60 minutes
- can be installed in bathrooms (IP44)
- built-in accumulator: 3 V, lithium
- operating temperature: -10 °C- +45 °C
- allowed humidity: 25-95%
- life time and warranty: 7 years
- LED indicators: power supply, alarm, fault, airing
- size: 100 x 72 x 36 mm



XC100-SK
Can be purchased only in Slovakia!

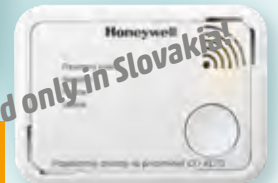

XC70-SK
Can be purchased only in Slovakia!

XS100T-HU

Combined heat and smoke detector

Honeywell

- with optical and heat detector for faster reaction and less false alarm
- for escape routes, bedrooms and parlours
- for bedrooms and halls
- high reliability
- easy installation
- protected against tampering
- easy to use user interface
- alarm noise level: >85 dB
- checks function
- power supply: built-in long life lithium battery, 3 V, not replaceable
- size: Ø116 x 42 mm



XS100-HU

Smoke detector

Honeywell

- with optical smoke detector
- for bathrooms and halls
- high reliability
- easy installation
- protected against tampering
- easy to use user interface
- alarm noise level: >85 dB
- checks function
- power supply: built-in long life lithium battery, 3 V, not replaceable
- size: Ø116 x 42 mm

XH100-HU

Fire detector, heat speed sensor

Honeywell

- heat speed detector to the kitchen for less false alarm
- high reliability
- easy installation
- protected against tampering
- easy to use user interface
- alarm noise level: >85 dB
- checks function
- power supply: built-in long life lithium battery, 3 V, not replaceable
- size: Ø116 x 42 mm

Insect and rodent repellent

If we want to protect ourselves and our property from pests, we will need insect and rodent repellents.

We offer you our favorable priced own brand products as well as high quality, Swedish SILVERLINE products. In our range of choice mosquito-, and electric insect traps can be found as well.

IKK 1 Outdoor insect killer with fan



The outdoor insect killer has purple UV-A light which attracts, and the fan sucks in the insects, e.g. flies, mosquitos, moths. Then the insects drops down into the plastic tray where they die.

- protected against splashing water (IPX4)
- effective range of 50 m²
- removable insect collector basket
- UV-A fluorescent lamp: 1 x 7 W (not home replaceable)
- length of power cable: 2 m
- power supply: 230 V~ / 50 Hz / 13 W
- size: Ø32 x 118 cm
- The lamp built into the unit is intended to be an insect killer, it is not suitable for lighting domestic premises!



IK 230 Electric indoor insect killer



- effective range of 20 m²
- purple UV-A light
- removable insect collector tray
- UV-A fluorescent lamp: 1 x 4 W (not home replaceable)
- length of power cable: 1,2 m
- power supply: 230 V~ / 50 Hz / 4 W
- size: 11,5 x 11,5 x 25 cm
- The lamp built into the unit is intended to be an insect killer, it is not suitable for illuminating domestic premises!



IK 240 Electric indoor insect killer



- effective range of 30 m²
- purple UV-A light
- removable insect collector tray
- UV-A fluorescent lamp: 1 x 6 W (not home replaceable)
- length of power cable: 1,2 m
- power supply: 230 V~ / 50 Hz / 6 W
- size: 13,5 x 13,5 x 32,5 cm
- The lamp built into the unit is intended to be an insect killer, it is not suitable for illuminating domestic premises!



UH 10 Ultrasonic insect repellent



- keeps mosquitos away in closed spaces
- effective range of 30 m²
- power supply: 230 V~ / 50 Hz / 0,5 W
- size: 5,6 x 3 x 2 cm



USR 4 Ultrasonic insect and rodent repellent



- deters rodents, insects and ants
- 4 different modes
- effective range: 2-5 m
- built-in torch
- LED battery charge indicator
- power supply: 2 x AAA (1,5 V) battery (not included), or network adapter (3 VDC / 100 mA) (not included)
- size: 8,3 x 5,5 x 2 cm



IN 25266 Portable mosquito repellent

SILVERLINE



- Mosquito Free Mobile™
- effective range: 1 m²
 - only against mosquitos and midges
 - 2 different frequencies
 - 1 pc LR44 (AG13) battery, included



IN 25241 Spider repellent, ultrasonic

SILVERLINE

- Spider Free 30™
- alternate dual-frequency ultrasonic signal output
 - effective range: 30 m²
 - for indoor use
 - not using poison
 - harmless to children, cats, dogs, birds, fishes
 - 230 V~ / 1 W



IN 25261 Electric mosquito repellent

SILVERLINE



- Mosquito Free 25™
- effective range: 25 m²
 - for indoor use
 - 2 different frequencies for optimum efficiencies
 - not using poison
 - harmless to children, cats, dogs, birds, fishes
 - 230 V~ / 1 W



IN 25151 Cat- and animal repellent

SILVERLINE®

- Cat & Animal Free 300™
- built-in motion sensor, senses and activates the alarm in 15 m range
 - stroboscopic LED can be turned on
 - high frequency sound emission
 - 6 pcs C (LR14) battery (not included)
 - can be used with external adapter (12 V / 500 mA, not included)



IN 25111 Electric mouse and rat repellent

SILVERLINE®



- Mice & Rat Free 80/200™
- combined ultrasonic and electromagnetic impulse
 - effective range: 80 m² ultrasonic / 200 m² electromagnetic
 - for indoor use
 - not using poison
 - harmless to children, cats, dogs, birds, fishes
 - 230 V~ / 1,8 W



IN 25101 Electric mouse and rat repellent

SILVERLINE®



- Mice & Rat Free 50™
- ultrasonic signal output
 - effective range: 50 m²
 - for indoor use
 - not using poison
 - harmless to children, cats, dogs, birds, fishes
 - 230 V~ / 0,5 W



IN 25105 Electric mouse and rat repellent

SILVERLINE®



- Mice & Rat Free 25™
- ultrasonic signal output
 - effective range: 25 m²
 - for indoor use
 - not using poison
 - harmless to children, cats, dogs, birds, fishes
 - 230 V~ / 1,5 W



IN 25130

Mole repellent stake

SILVERLINE

- Vole & Mole Free PowerVib 1250™
- effective range: 1250 m² depending of the soil type
 - can be used on sandy soil
 - low frequency noise
 - circular spread
 - 4 pcs D (LR20) 1.5 V battery (not included)
 - length of the stake: 38 cm



VKS 02

Solar mole repellent stake

- The vibrations effectively scares off the rodents and moles. The device can work at night as well, due to the built-in accumulator.
- large solar panel (90 x 60 mm)
 - emits vibration in every 30 sec
 - frequency range: 400 Hz +/- 100 Hz
 - material: plastic + aluminium stake
 - effective area: 350 m²
 - built-in accumulator: 1,2 V / 600 mAh / AA (NiMH)
 - size: Ø15,5 x 26 cm



VKS 03

Solar mole repellent stake

- The vibrations effectively scares off the rodents and moles. The device can work at night as well, due to the built-in accumulator.
- large solar panel (90 x 60 mm)
 - 250 mm aluminium stake
 - emits vibration in every 30 sec
 - frequency range: 400 Hz +/- 100 Hz
 - effective area: 800 m²
 - built-in accumulator: 1,2 V / 300 mAh / AA (NiMH)
 - size: Ø15 x 31 cm



VK 01

Mole repellent stake

- auto-vibrations keeps off rodents
- suitable to scare off moles, voles, mole-rats
- the noise does not disturbs human or other animals
- depending on the soil type the effective range is 3000 m²
- very low consumption, it works up to 3-4 months with one battery
- power supply: 1 x 6LR61 (9 V) battery (not included)
- size: Ø4 x 30 cm



VKS 04

Solar mole repellent stake with LED light

- The vibrations effectively scares off the rodents and moles. Due to the built-in accumulator a LED light illuminates in the dark and the repellent can work at night.
- large solar panel (90 x 60 mm)
 - LED light in the upper part of the stake
 - 250 mm aluminium stake
 - emits vibrations in every 50 sec.
 - frequency range: 400 Hz +/- 100 Hz
 - effective area: 800 m²
 - built-in accumulator: 1,2 V / 300 mAh / AA (NiMH)
 - size: Ø15 x 37 cm





Lightings

The variety of our lighting product have been expanded with variously shaped and sized LED lanterns. We recommend our colored light bulb strings, micro LED light strings, lighting tree decorations etc. for events, parties, weddings. The advantage of our white wired, connectable light garlands is that we can use 1200 LEDs simultaneously with only one power cable.



LTN 6 LED lantern



- for indoor use
- 1 pc of orange, flickering LED
- wooden base + metal roof + glass
- power supply: 3 x 1,5 V (AAA) batteries, not included
- size: 20 x 20 x 44 cm

LTN 7 LED lantern



- for indoor use
- 1 pc of orange, flickering LED
- wooden base + metal roof + glass
- power supply: 3 x 1,5 V (AAA) batteries, not included
- size: 14 x 14 x 29,5 cm



LTN 9 LED lantern



- for indoor use
- 1 pc of orange, flickering LED
- metal base + glass
- power supply: 3 x 1,5 V (AAA) batteries, not included
- meret: 12,5 x 12,5 x 27,5 cm



LTN 3/BK LED lantern

- black



- for indoor use
- 1 pc of orange, flickering LED
- plastic + glass
- modes: OFF / timer (6 h ON + 18 h OFF) / ON
- power supply: 3 x 1,5 V (AAA) batteries, not included
- size: 18,5 x 18,5 x 35 cm



LTN 3/WH

- white

LTN 4/BK LED lantern



- for indoor use
- 1 pc of orange, flickering LED
- black plastic + glass
- power supply: OFF / timer (6 h ON + 18 h OFF) / ON
- power supply: 3 x 1,5 V (AAA) batteries, not included
- size: Ø19,2 x 32,8 cm



LTN 2/BK LED lantern

- black



- for indoor use
- 1 pc of orange, flickering LED
- plastic + glass
- modes: OFF / timer (6 h ON + 18 h OFF) / ON
- power supply: 3 x 1,5 V (AAA) batteries, not included
- size: 15,5 x 15,5 x 24,5 cm



LTN 2/WH

- white

LTN 1/WH LED lantern



- for indoor use
- 1 pc of orange, flickering LED
- white plastic + glass
- modes: OFF / timer (6 h ON + 18 h OFF) / ON
- power supply: 3 x 1,5 V (AA) batteries, not included
- size: Ø12 x 20,6 cm



LED lantern

LTN 10/RD

LED lantern

- red



- for indoor use
- metal
- 1 pc of orange, flickering LED tea light
- power supply: 1 x 3V CR2032 button battery, included
- size: 7,5 x 7,5 x 12 cm



LTN 10/WH

- white



LTN 10/GR

- green

LTN 11/YE

LED lantern

- yellow



- for indoor use
- metal
- 1 pc of orange, flickering LED tea light
- power supply: 1 x 3V CR2032 button battery, included
- size: Ø12 x 11 cm



LTN 11/PL

- purple



LTN 11/BL

- blue

GB 23/BL

Decoration bottle with LED tea light

- blue



- for indoor use
- can be hung, 30 cm chain
- 1 pc of orange, flickering LED tea light
- power supply: 1 x 3V CR2032 button battery, included
- size: Ø8 x 23 cm



GB 23/YE

- yellow



GB 23/RD

- red

GB 30/YE

Decoration bottle with LED light chain

- yellow



- for indoor use
- matte coloring
- 10 pcs of warm white LEDs tea light
- power supply: 3 x 1,5V AAA batteries, not included
- size: Ø7,3 x 30 cm



GB 30/PK

- pink



GB 30/BL

- blue

MX 101

Solar cell decoration



- made of metal / plastic
- light source: 1 pc of color changing LED
- turns ON/OFF automatically
- built-in solar panel and accumulator charger: charges at daytime, lights at night
- weatherproof design
- can be hung
- replaceable (1,2 V / 250 mAh) AAA NiMH accumulator
- size: 17,5 x 43,5 cm

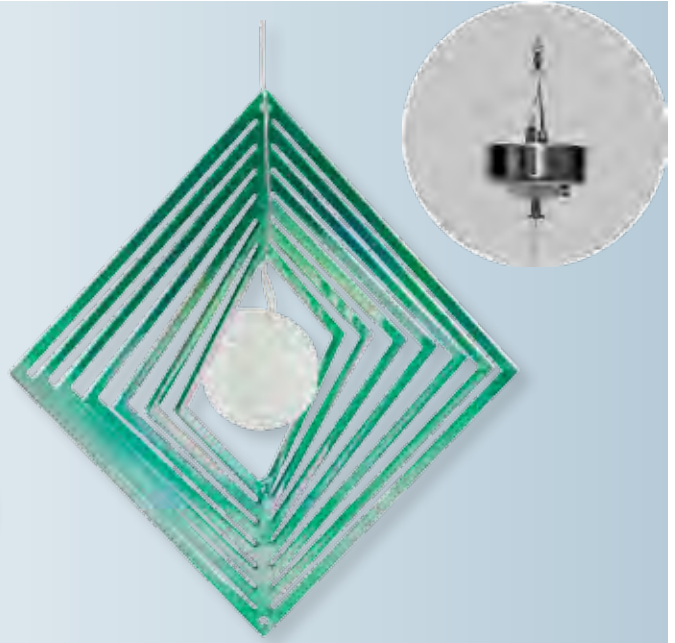
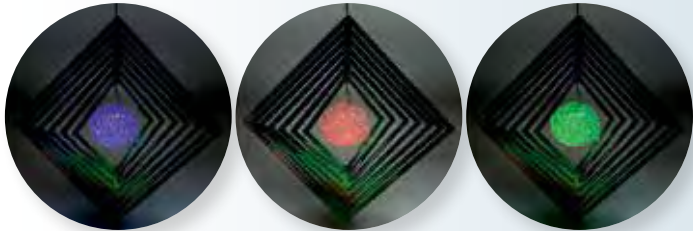

MX 102

Solar garden light, dragonfly



- made of metal / plastic
- light source: 3 pcs color changing LEDs
- turns ON/OFF automatically
- built-in solar panel and accumulator charger: charges at daytime, lights at night
- weatherproof design
- can be hung
- replaceable (1,2 V / 250 mAh) AAA NiMH accumulator
- size: 15 x 80 cm



MX 616P

Solar garden light

- butterfly



- turns ON/OFF automatically: charges at daytime, lights at night
- up to 8 hours of continuous operation
- built-in solar panel and accumulator charger
- 1 pc of bright color changing LED
- weatherproof design
- it can be inserted to the ground
- replaceable (1,2 V / 600 mAh) AA NiMH accumulator
- size: 80 cm



MX 616S

- dragonfly



MX 616K

- hummingbird



MX 616T

- tulip

MX 801**Solar garden light, butterfly****AUTO
ON-OFF**

- metal / glass design
- light source: 4 pcs of warm white LED
- turns ON/OFF automatically
- built-in solar panel and accumulator charger: charges at daytime, lights at night
- weatherproof design
- can be hung
- power supply (1,2 V / 250 mAh) AA NiMH accumulator
- size: 54,5 x 4 x 41 cm

**MX 617****Rotating solar flower****AUTO
ON-OFF**

- made of stainless steel + plastic
- light source: 1 of white LED
- can be stuck into the ground
- ON/OFF switch at the back of the solar panel
- replaceable (1,2 V/300 mAh) AA NiMH accumulator
- diameter of the flower: 30 cm
- size: 75 cm

**MX 203****Solar panel colour lantern chain****AUTO
ON-OFF**

- 10 lanterns, material: nylon
- diameter of each lampion: approx. 8 cm
- 18 cm distance between lampions
- light source: 10 pcs of white LEDs
- 130 cm power cable
- continuous and flashing light modes
- solar panel can be wall-mounted or can be stuck in the ground
- ON/OFF switch at the back of the solar panel
- replaceable (1,2 V/600 mAh) AA NiMH accumulator

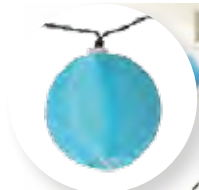
**MX 512/K****Solar mosaic light****AUTO
ON-OFF**

- turns ON/OFF automatically: charges at daytime, lights at night
- up to 8 hours of continuous operation
- built-in solar panel and accumulator charger
- 1 pc of white LED
- weatherproof exterior
- replaceable (1,2 V/300 mAh) AA NiMH accumulator
- size: Ø11,5 x 10,5 cm

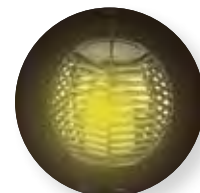
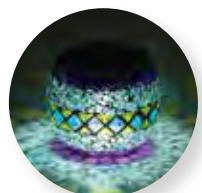
**MX 500****Solar light, shyntetic rattan****AUTO
ON-OFF**

- turns ON/OFF automatically: charges at daytime, lights at night
- up to 8 hours of continuous operation
- built-in solar panel and accumulator charger
- 1 pc of yellow LED
- candle-like yellow flickering light
- replaceable (1,2 V / 500 mAh) AA NiMH accumulator
- size: Ø18 x 28 cm



MX 636

Solar lamp, mole figure

**AUTO
ON-OFF**

- turns ON/OFF automatically: charges at daytime, lights at night
- built-in solar panel and accumulator charger
- 2 pcs of bright white LEDs
- weatherproof design
- replaceable (1,2V / 300 mAh) AA NiMH accumulator
- size: 13 x 12 x 23,5 cm



MX 638

Solar lamp, frog figure

**AUTO
ON-OFF**

- turns ON/OFF automatically: charges at daytime, lights at night
- built-in solar panel and accumulator charger
- 2 pcs of bright white LEDs
- weatherproof design
- replaceable (1,2V / 300 mAh) AA NiMH accumulator
- size: 13,5 x 11 x 25 cm

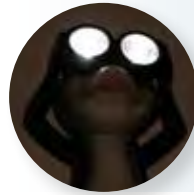

MX 631A

Solar lamp, dog figure

**AUTO
ON-OFF**



- turns ON/OFF automatically: charges at daytime, lights at night
- up to 8 hours of continuous operation
- 1 pc of bright color changing LED
- built-in solar panel and accumulator charger
- replaceable (1,2V / 250 mAh) AA NiMH accumulator
- size: 25 cm

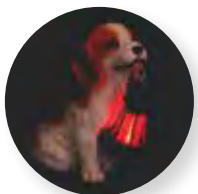

MX 633A

Solar lamp, truck figure

**AUTO
ON-OFF**

- turns ON/OFF automatically: charges at daytime, lights at night
- up to 8 hours of continuous operation
- built-in solar panel and accumulator charger
- 2 pcs of bright white LED
- weatherproof design
- replaceable (1,2V / 300 mAh) AA NiMH accumulator
- size: 22,5 x 11,5 x 13,5 cm



MX 632A

Solar lamp, smurf figure

**AUTO
ON-OFF**

- turns ON/OFF automatically: charges at daytime, lights at night
- up to 8 hours of continuous operation
- strong plastic housing with built-in spotlight
- 1 pc of bright white LED
- built-in solar panel and accumulator charger
- replaceable (1,2V / 300 mAh) AA NiMH accumulator
- size: 25 cm

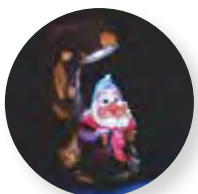

MX 632C

Solar lamp, smurf figure

**AUTO
ON-OFF**



- turns ON/OFF automatically: charges at daytime, lights at night
- up to 8 hours of continuous operation
- 1 pc of bright color changing LED
- built-in solar panel and accumulator charger
- replaceable (1,2V / 600 mAh) AA NiMH accumulator
- size: 25 cm

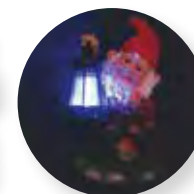

MX 804/4

Solar garden light, 4 pcs



- made of metal / plastic
- light source: 1 pc of white LED
- turns ON/OFF automatically
- built-in solar panel and accumulator charger: charges at daytime, lights at night
- weatherproof design
- can be stuck into the ground
- replaceable (1,2 V/300 mAh) 2/3 AA NiMH accumulator
- size: Ø5 x 39,8 cm



MX 805/4

Solar garden light, 4 pcs



- made of metal / plastic
- light source: 1 pc of white LED
- turns ON/OFF automatically
- built-in solar panel and accumulator charger: charges at daytime, lights at night
- weatherproof design
- can be stuck into the ground or fixed by screws
- replaceable (1,2 V/200 mAh) AA NiMH accumulator
- size: Ø6,2 x 37 cm



MX 807/4

Solar garden light, 4 pcs



- made of metal / plastic
- light source: 1 pc of white LED
- turns ON/OFF automatically
- built-in solar panel and accumulator charger: charges at daytime, lights at night
- weatherproof design
- can be stuck into the ground
- replaceable (1,2 V 200 mAh) AAA NiMH accumulator
- size: Ø8 x 37,5 cm



MX 811/4

Solar garden light, 4 pcs



- made of metal / glass / plastic
- light source: 1 pc of color changing LED
- turns ON/OFF automatically
- built-in solar panel and accumulator charger: charges at daytime, lights at night
- weatherproof design
- can be stuck into the ground
- replaceable (1,2 V 200 mAh) AAA NiMH accumulator
- size: Ø8 x 37 cm

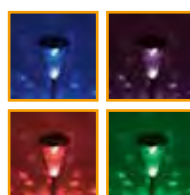

MX 802/4

Solar garden light, 4 pcs



- made of metal / plastic
- light source: 1 pc of white LED
- turns ON/OFF automatically
- built-in solar panel and accumulator charger: charges at daytime, lights at night
- weatherproof design
- chrysal-like head
- can be stuck into the ground
- replaceable (1,2 V/200 mAh) AAA NiMH accumulator
- size: Ø8 x 34,5 cm



MX 812 Solar garden light, glass sphere



- made of metal / glass
- light source: 1 pc of white LED
- turns ON/OFF automatically
- built-in solar panel and accumulator charger: charges at daytime, lights at night
- weatherproof exterior
- can be stuck into the ground
- replaceable (1,2 V/300 mAh) AA NiMH accumulator
- size: Ø8 x 37,5 cm



MX 826 Solar garden light, glass sphere



- made of metal / glass
- 2 modes: 1 pc of white LED or 1 pc of color changing LED
- turns ON/OFF automatically
- built-in solar panel and accumulator charger: charges at daytime, lights at night
- weatherproof exterior
- can be stuck into the ground
- replaceable (1,2 V / 300 mAh) AA NiMH accumulator
- size: Ø12 x 56 cm



MX 715D Solar garden light



- turns ON/OFF automatically
- up to 8 hours of continuous operation
- built-in solar panel and accumulator charger: charges at daytime, lights at night
- 1 pc of bright white LED
- weatherproof exterior
- made of stainless steel
- can be stuck into the ground
- replaceable (1,2 V / 600 mAh) AA NiMH accumulator
- size: Ø12 x 40 cm



MX 459/1 Solar garden light, glass mosaic



- turns ON/OFF automatically: charges at daytime, lights at night
- up to 8 hours of continuous operation
- built-in solar panel and accumulator charger
- 1 pc of white LED
- weatherproof exterior
- replaceable (1,2 V/300 mAh) AA NiMH accumulator
- size: Ø7,4 x 39 cm



MX 838/P Solar garden light

- pink decoration



- made of metal, with pink decoration
- turns ON/OFF automatically
- up to 8 hours of continuous operation
- with ON/OFF switch
- built-in solar panel and accumulator charger: charges at daytime, lights at night
- 1 pc of white LED
- replaceable (1,2 V / 600 mAh) AAA NiMH accumulator
- size: Ø9 x 35 cm



MX 838 /WH

MX 838 /OR

- white decoration

- orange decoration



MX 819/1

Solar garden light



- made of metal / plastic
- 1 pc of Ø5 mm white, and 1 pc of Ø5 mm color changing LED
- size: Ø6 x 41,5 cm



MX 803

Solar garden light



- made of metal / plastic
- light source: 1 pc of white LED
- turns ON/OFF automatically
- built-in solar panel and accumulator charger: charges at daytime, lights at night
- weatherproof design
- can be used as a table lamp, be hung or stuck into the ground
- replaceable (1,2V/300 mAh) AAA NiMH accumulator
- size: Ø9 x 40 cm



MX 720

Solar garden light



- made of plastic
- light source: 1 pc of white LED
- turns ON/OFF automatically
- built-in solar panel and accumulator charger: charges at daytime, lights at night
- weatherproof design
- can be stuck into the ground
- replaceable (1,2V/200 mAh) AAA NiMH accumulator
- size: 4,9 x 4,9 x 38 cm



MX 720/4

- 4 pcs / pack



MX 760

Solar garden light



- turns ON/OFF automatically
- up to 8 hours of continuous operation
- built-in solar panel and accumulator charger: charges at daytime, lights at night
- 1 pc of bright white LED
- weatherproof design
- can be stuck into the ground
- replaceable (1,2V / 600 mAh) AA NiMH accumulator
- size: Ø12,5 x 45,5 cm



MX 737

Solar garden light



- turns ON/OFF automatically
- up to 8 hours of continuous operation
- built-in solar panel and accumulator charger: charges at daytime, lights at night
- 1 pc of bright white LED
- weatherproof design
- can be stuck into the ground
- replaceable (1,2V / 250 mAh) AAA NiMH accumulator
- size: Ø5,6 x 37 cm



MX 621A

Solar garden light, mountable



- turns ON/OFF automatically: charges at daytime, lights at night
- up to 8 hours of continuous operation
- metal housing, glass top cover
- water-, and shockproof
- 1 pc of bright LED
- built-in solar panel and accumulator charger
- replaceable (1,2V / 250 mAh) AAA NiMH accumulator
- size: Ø12 x 4 cm



NiMH accumulator

- to replace the accumulators in solar lights



The photo is an illustration!

M 600AA/2

- (AA)
- 1,2V / 600 mAh
- 2 pcs/blister

M 300AA/2

- (AA)
- 1,2V / 300 mAh
- 2 pcs/blister

M 300AAA/2

- mini (AAA)
- 1,2V / 300 mAh
- 2 pcs/blister

CMW 15

LED candle decoration



- moving flame effect
- made of real wax
- moving wick
- 1 pcs of yellow LED
- power supply: 2 x 1,5 V (AA) batteries, not included
- size: Ø7,5 x 15 cm



CDW 4

LED wax candle set



- 4 pcs
- molten wax-like shape
- 1 pc of yellow flickering LED
- with ON/OFF slide switch
- power supply: 1 x CR2032 (3 V) battery, included
- size: Ø5 x 7,5 cm



CDW 10

LED wax candle decoration



- orange flickering LED
- made of wax
- power supply: 3 x 1,5 V (AAA) batteries (not included)
- size: Ø7,5 x 10 cm



CDW 3

LED wax candle set



- with metal-like decoration
- with wooden plate and decor pearls
- 1 pc of yellow flickering LED in each candle
- power supply in each candle: 3 x AAA (1,5 V) batteries (not included)
- size: plate: 28 x 12,5 cm
candles: Ø7,5 x 15 / 12,5 / 10 cm



CDR 3/M

LED wax candle set, with remote control



- colors can be chosen or continuously changing
- optional continuous or flickering light
- memory: by turning off with the remote control, it memorises the color and mode use last time
- 4 or 8 hour timer
- power supply of the remote control: 1 x CR2025 battery, included
- power supply of the candles: 3 x 1,5 V (AAA) batteries in each candle (not included)
- size: Ø7,5 x 15 / 12,5 / 10 cm

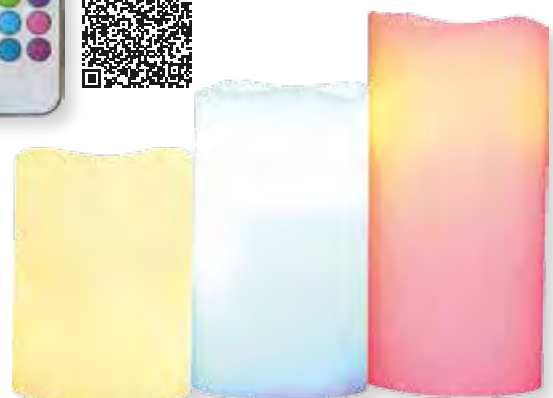

CD SERIES

LED tea light



CD 2/GOLD



CD 2/RED



CD 2/SILVER



CD 2/GX



CD 2/SX



CD 2/WX



CD 6/WH



CDB 2/WH

type	description	size	light type	light color	power supply
CD 2/GOLD	LED tea light, bright gold, 2 pcs/blister	Ø38 mm	LED	orange	1 x CR2032 (3 V) button battery (included)
CD 2/RED	LED tea light, bright red, 2 pcs/blister	Ø38 mm	LED	orange	1 x CR2032 (3 V) button battery (included)
CD 2/SILVER	LED tea light, bright silver, 2 pcs/blister	Ø38 mm	LED	orange	1 x CR2032 (3 V) button battery (included)
CD 2/GX	LED tea light, gold glitter, 2 pcs/blister	Ø38 mm	LED	orange	1 x CR2032 (3 V) button battery (included)
CD 2/SX	LED tea light, silver glitter, 2 pcs/blister	Ø38 mm	LED	orange	1 x CR2032 (3 V) button battery (included)
CD 2/WX	LED tea light, white, 2 pcs/blister	Ø38 mm	LED	orange	1 x CR2032 (3 V) button battery (included)
CD 6/WH	LED tea light, white, 6 pcs/blister	Ø38 mm	LED	orange	1 x CR2032 (3 V) button battery (included)
CDB 2/WH	LED tea light, white, 2 pcs/blister	Ø59 mm	LED	orange	2 x 1,5 V (AAA) battery (not included)

CDX 1

LED light



- orange, flickering LED
- approx. 60 days of continuous operation
- power supply: 2 x 1,5 V (AA) batteries (not included)
- size: Ø5 x 8 cm



CDG SERIES

LED tea light



CDG 1/GR



CDG 1/OR



CDG 1/RD



CDG 1/YE



CDG 1/T

type	description	size	light type	light color	power supply
CDG 1/GR	LED tea light in green glass cup	tea light: Ø38 mm cup: Ø45 mm	LED	orange	1 x CR2032 (3 V) button battery (included)
CDG 1/OR	LED tea light in orange glass cup	tea light: Ø38 mm cup: Ø45 mm	LED	orange	1 x CR2032 (3 V) button battery (included)
CDG 1/RD	LED tea light in red glass cup	tea light: Ø38 mm cup: Ø45 mm	LED	orange	1 x CR2032 (3 V) button battery (included)
CDG 1/YE	LED tea light in yellow glass cup	tea light: Ø38 mm cup: Ø45 mm	LED	orange	1 x CR2032 (3 V) button battery (included)
CDG 1/T	LED tea light in transparent glass cup	tea light: Ø38 mm cup: Ø45 mm	LED	orange	1 x CR2032 (3 V) button battery (included)

FOL 3 Fiber optic LED light



- 3 pcs of LED (red/blue/green)
- 8 modes: selectable permanent color, color combinations, continuously changing color
- power supply: 3 x 1,5 V (AA) batteries (not included)
- Ø8 x 9 cm lamp body
- 28 cm long optical fibres



ML 10 GLOBE LED light chain



- 10 pcs of glass bulbs
- 50 pcs of warm white micro LEDs
- power supply: 3 x 1,5 V (AA) batteries, not included
- size: 2,25 m + 50 cm power cable



LP 20/WW LED light chain



- 20 pcs of plastic bulbs
- 20 pcs of warm white LEDs
- transparent cable
- power supply: IP44 outdoor adapter
- size: 9,5 m + 5 m power cable



LP 10/M LED bulb light chain



- 10 pcs of colored plastic bulbs
- 3 pcs warm white LEDs in each bulb
- totally 30 pcs LEDs
- power supply: IP44 outdoor network adapter
- size: 2,25 m + 5 m power cable



LPL 10 LED light chain



- 10 pcs of colored LED bulbs
- 5 cm plastic bulbs
- power supply: 230 V~ / 24 V adapter
- size: 4,5 m + 5 m power cable

LPL 30 LED light chain



- 30 pcs of colored LED bulbs
- 5 cm plastic bulbs
- power supply: 230 V~ / 24 V adapter
- size: 14,5 m + 5 m power cable



MLC 13/HB

LED light chain



- 13 pcs of warm white LEDs
- transparent cable
- power supply: 2 x 1,5V (AA) batteries, not included
- size: 1,35 m + 30 cm power cable



ML 80/WW

Micro LED light chain

- warm white



- thin cable
- shines brightly, point-like micro LEDs
- power supply: outdoor IP44 adapter
- size: 7,9 m + 3 m power cable

ML 80/WH

- cold white

ML 20/WW

Micro LED light chain

- 20 pcs of warm white micro LEDs
- size: 1,9 m + 20 cm power cable



- thin cable
- shines brightly, point-like micro LEDs
- with on/off switch
- power supply: 2 x 1,5 V (AA) batteries, not included

ML 50/WW

- 50 pcs of warm white micro LEDs
- 4,9 m + 30 cm power cable

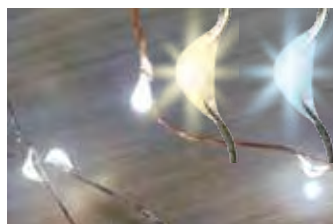

MLC 30/M

LED mini light chain

- colored



- 30 pcs of LEDs
- transparent cable
- with on/off switch
- power supply: 3 x 1,5 V (AA) batteries (not included)
- size: 2,9 m + 40 cm power cable

MLC 30/WW

- warm white

MLC 30/WH

- cold white



Decorative lights

For weddings, party decorations, events

KAD 18

LED tree shape table decoration

- for indoor use
- 16 pcs of cold white LEDs
- power supply: 3 x AA (1,5 V) batteries (not included)
- size: Ø9 x 38 cm



KAD 17

LED tree shape table decoration

- for indoor use
- 8 pcs of warm white LEDs
- power supply: 3 x AA (1,5 V) batteries (not included)
- size: Ø9 x 38 cm



CBT 320

LED cherry tree decoration

- for indoor and outdoor use
- 320 pcs of warm white LEDs
- cherry blossom ornament
- branches can be set to your preference
- power supply: outdoor IP44 adapter
- size: 2 m + 10 m power cable



CBT 200

LED cherry tree decoration

- for indoor and outdoor use
- 200 pcs of warm white LEDs
- cherry blossom ornament
- removable metal base, Ø17 cm
- power supply: outdoor IP44 adapter
- size: 1,5 m + 5 m power cable



GPL 25

LED buxus

- for indoor use
- realistic plant
- 25 pcs of warm white LEDs
- power supply: 2 x 1,5 V (AA) batteries, not included
- size: Ø15 x 43 cm



GLE SERIES

LED decoration

- flexible EVA material
- power supply: 3 x 1,5 V (AA) batteries, not included



GLE 12/WW

- 1 pc of warm white LED
- Ø12 cm

GLE 15/WW

- 2 pcs of warm white LEDs
- Ø15 cm

GLE 20/WW

- 2 pcs of warm white LEDs
- Ø20 cm



CDF SERIES

LED water resistant tea light, 12 pcs

- 1 pc of LED with steady light
- in water it sinks down to the bottom of the container
- power cable: 2 x CR2032 batteries, included
- size: Ø3 cm



CDF 1/WH

- cold white

CDF 1/WW

- warm white



KAD 20 STAR

LED table decoration, star

- for indoor use
- 20 pcs of warm white LEDs
- material: ABS plastic
- power supply: 3 x 1,5 V (AA) batteries, not included
- size: 25 x 39 cm



DECO SERIES

Decoration for Ø5 mm LED light chains

It is recommended for the following products:

KI 50 LED, KI 100 LED, KI 200 LED, KKL 100, KKL 200, KKL 500, KKL 1000, LED 108, LED 208 series

DECO 2 - sphere, 12 mm, 50 pcs

DECO 3 - butterfly, 70 x 50 mm, 20 pcs

DECO 5 - cube, 22 x 15 mm, 50 pcs

DECO 7 - flower, 24 x 15 mm, 50 pcs



Connectable light curtains

Up to 1200 LEDs can be powered from a single mains connection!

For indoor and outdoor use • Steady light • White cable • Without power cable and adapter! • To connect the product to the power socket, only the DLA 12W adapter and DLC 5M power cable should be used! • Up to 1200 LEDs can be powered from a single mains connection!



- cold white



- warm white



DLF SERIES

Connectable light curtains



DLF 400/WH

- cold white



DLF 400/WW

- warm white



DLF 600/WH

- cold white



DLF 600/WW

- warm white

DLF 400

- for indoor and outdoor use
- 400 pcs of LEDs
- 20 garlands with 20 LEDs on each one
- size: 2 x 2 m + 15-15 cm power cable

The mains adapter and power cable are not included!

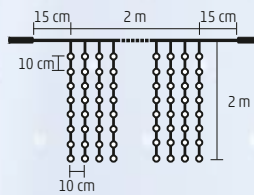

DLF 600

- for indoor and outdoor use
- 600 pcs of LEDs
- 20 garlands with 30 LEDs on each one
- size: 2 x 3 m + 15-15 cm power cable

The mains adapter and power cable are not included!

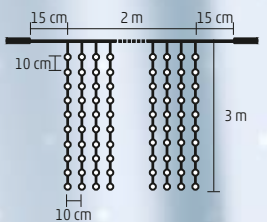

DLFJ 200 SERIES

LED connectable icicle light curtain

- for indoor and outdoor use
- 200 pcs of LEDs
- 3/7/4/6 garlands, 10 groups
- steady light
- size: 5 m + 15-15 cm power cable

The mains adapter and power cable are not included!

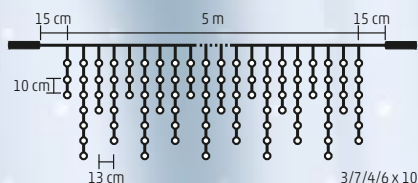

DLFJ 200/WH

- cold white



DLFJ 200/WW

- warm white

Up to 1200 LEDs can be powered from a single mains connection!

Connectable light curtains

For indoor and outdoor use • Steady light • White cable • Without power cable and adapter! • To connect the product to the power socket, only the DLA 12W adapter and DLC 5M power cable should be used! • Up to 1200 LEDs can be powered from a single mains connection!

DLI SERIES

Connectable LED light chain



DLI 40/WH

- cold white



DLI 40/WW

- warm white



DLI 200/WH

- cold white



DLI 200/WW

- warm white

DLI 40

- for indoor and outdoor use
- 40 pcs of LEDs
- size: 2 m + 15-15 cm power cable

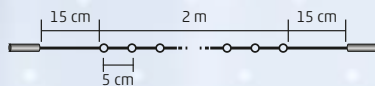

The mains adapter and power cable are not included!

DLI 200

- for indoor and outdoor use
- 200 pcs of LEDs
- size: 10 m + 15-15 cm power cable

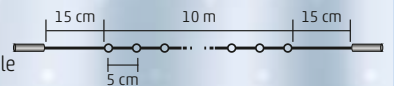

The mains adapter and power cable are not included!

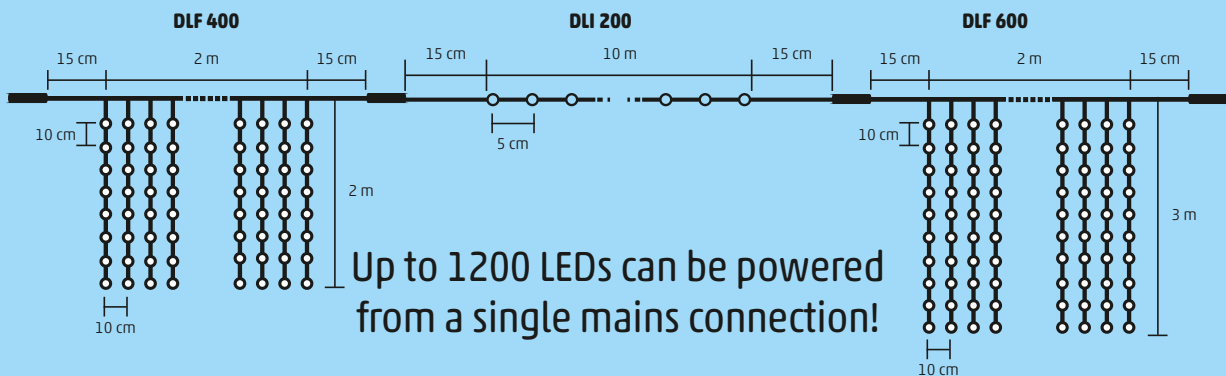

DLA 12W

Mains adapter for DLI/DLF/DLFJ

- IP44, protected against splashing water
- Can be directly connected exclusively to the DLC 5M power cable marketed by Somogyi Electronic!

12 Watt



DLC 5M

Power cable/connector cable for DLI/DLF/DLFJ

- Can be directly connected exclusively to the DLI/DLF/DLFJ products and DLA 12W mains adapter marketed by Somogyi Electronic!



LA 7 BT

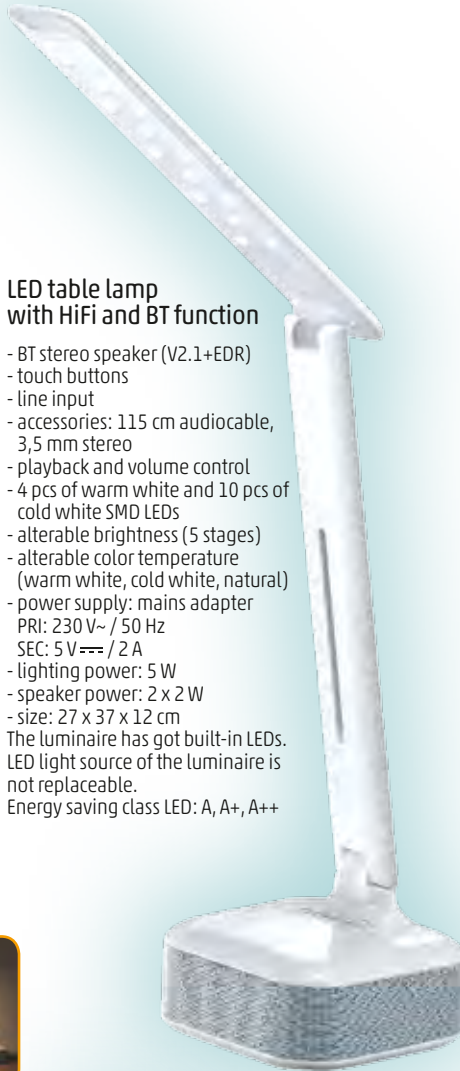

LED table lamp with HiFi and BT function

- BT stereo speaker (V2.1+EDR)
 - touch buttons
 - line input
 - accessories: 115 cm audiocable, 3,5 mm stereo
 - playback and volume control
 - 4 pcs of warm white and 10 pcs of cold white SMD LEDs
 - alterable brightness (5 stages)
 - alterable color temperature (warm white, cold white, natural)
 - power supply: mains adapter
PRI: 230 V~ / 50 Hz
SEC: 5 V --- / 2 A
 - lighting power: 5 W
 - speaker power: 2 x 2 W
 - size: 27 x 37 x 12 cm
- The luminaire has got built-in LEDs. LED light source of the luminaire is not replaceable.
Energy saving class LED: A, A+, A++



LA 6

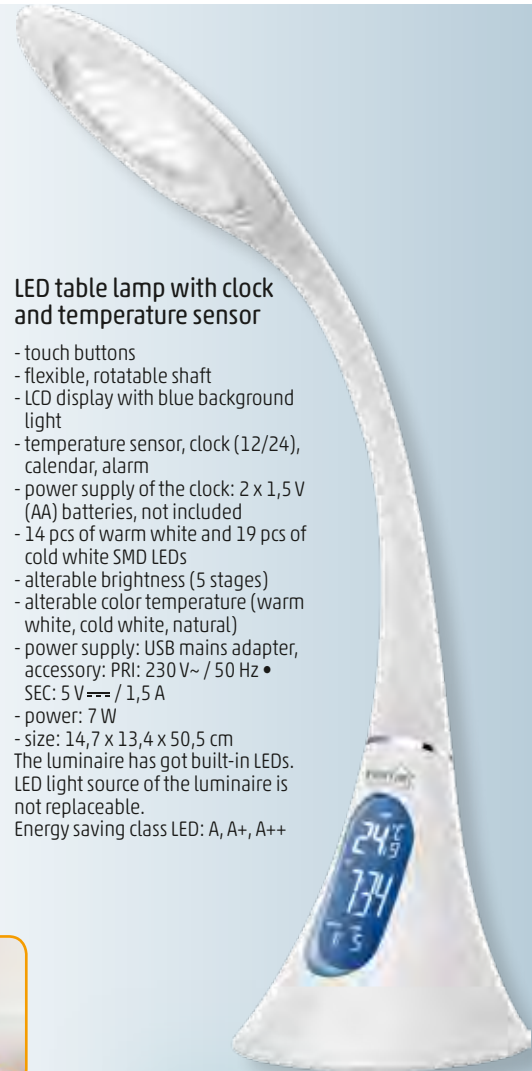

LED table lamp with clock and temperature sensor

- touch buttons
 - flexible, rotatable shaft
 - LCD display with blue background light
 - temperature sensor, clock (12/24), calendar, alarm
 - power supply of the clock: 2 x 1,5 V (AA) batteries, not included
 - 14 pcs of warm white and 19 pcs of cold white SMD LEDs
 - alterable brightness (5 stages)
 - alterable color temperature (warm white, cold white, natural)
 - power supply: USB mains adapter, accessory: PRI: 230 V~ / 50 Hz • SEC: 5 V --- / 1,5 A
 - power: 7 W
 - size: 14,7 x 13,4 x 50,5 cm
- The luminaire has got built-in LEDs. LED light source of the luminaire is not replaceable.
Energy saving class LED: A, A+, A++



LA 5

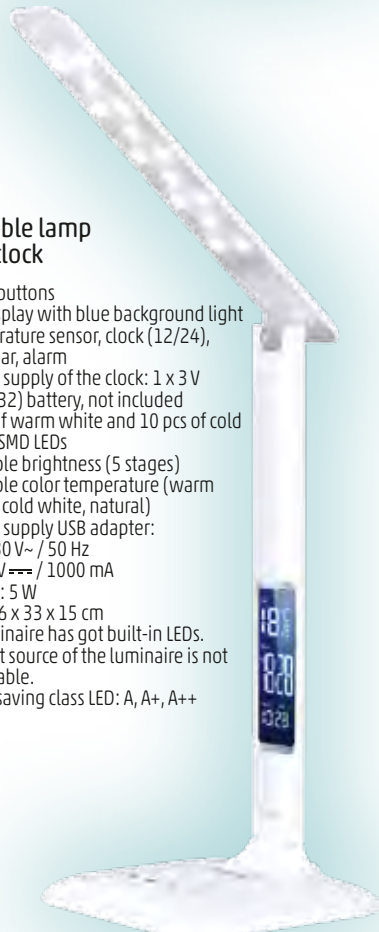

LED table lamp with clock

- touch buttons
 - LCD display with blue background light
 - temperature sensor, clock (12/24), calendar, alarm
 - power supply of the clock: 1 x 3 V (CR 2032) battery, not included
 - 4 pcs of warm white and 10 pcs of cold white SMD LEDs
 - alterable brightness (5 stages)
 - alterable color temperature (warm white, cold white, natural)
 - power supply USB adapter:
PRI: 230 V~ / 50 Hz
SEC: 5 V --- / 1000 mA
 - power: 5 W
 - size: 26 x 33 x 15 cm
- The luminaire has got built-in LEDs. LED light source of the luminaire is not replaceable.
Energy saving class LED: A, A+, A++

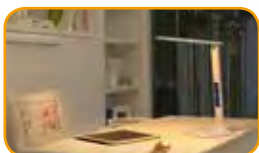

LA 3

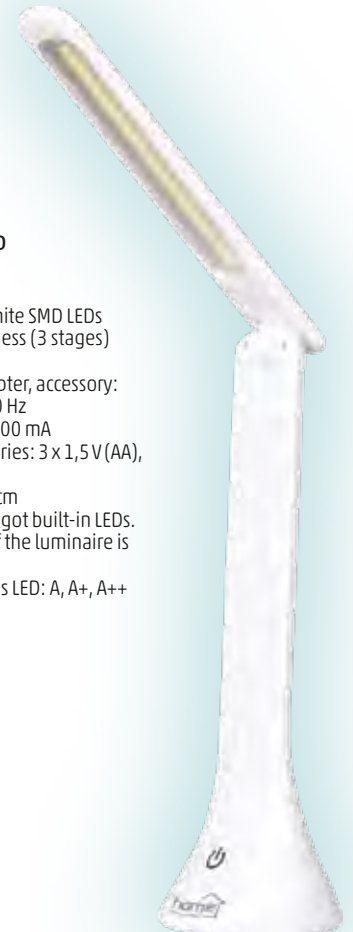

LED table lamp

- touch buttons
 - 16 pcs of cold white SMD LEDs
 - alterable brightness (3 stages)
 - power supply:
 - USB mains adapter, accessory: PRI: 230 V~ / 50 Hz SEC: 5 V --- / 1000 mA
 - alkaline batteries: 3 x 1,5 V (AA), not included
 - size: 8 x 16 x 22 cm
- The luminaire has got built-in LEDs. LED light source of the luminaire is not replaceable.
Energy saving class LED: A, A+, A++

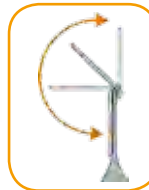

HL043 ORANGE Table lamp, duck figure

- orange design
- adjustable light head
- built-in analog alarm clock (1 x AA battery, not included)
- G23 socket, max. 11 W
- accessory: fluorescent lamp (B energy class)
- power supply: 230 V~ / 50 Hz
- size: 36 x 46 cm
- The luminaire can operate with the following energy class of fluorescent lamps: B

HL045 PINK Table lamp, cat figure

- pink design
- adjustable light head
- G10q socket, 15 W
- accessory: fluorescent lamp (B energy class)
- power supply: 230 V~ / 50 Hz
- size: 19,5 x 43 cm
- The luminaire can operate with the following energy class of fluorescent lamps: B

HL046 WHITE Table lamp, dog figure

- black/white design
- adjustable light head
- G10q socket, 15 W
- accessory: fluorescent lamp (B energy class)
- power cable: 230 V~ / 50 Hz
- size: 23 x 45 cm
- The luminaire can operate with the following energy class of fluorescent lamps: B

HL047 BLUE Table lamp, boy playing tennis figure

- blue hat boy design
- adjustable light head
- with analog alarm (1 x AA elem, nem tartozek)
- G10q socket, 15 W
- accessory: fluorescent lamp (B energy class)
- power supply: 230 V~ / 50 Hz
- size: 20,5 x 40 cm
- The luminaire can operate with the following energy class of fluorescent lamps: B



HLP 2 0 LED head light for kids

- owl



- 2 bright, cold white DIP LEDs
- 2 functions: flickering or continuous light
- flexible luminaire
- adjustable headband
- power supply: 2 x 1,5 V (AAA) batteries (not included)
- size: 7,5 x 6,5 x 5 cm



HLP 2 D

- dog



HLP 2 L

- lion



HLP 2 P

- panda

LED nightlight



- projects the starry sky onto the rooms walls
- glowing or continuous light by pressing the button
- selectable colors and automatic color changing
- optional automatic turn-off after approx. 20 minutes
- 3 in 1: decoration, nightlight and relaxation
- energy saving and safe LED technology
- power supply: 3 x AAA (1,5 V) batteries, not included
- can be powered with a 4,5 V mains adapter (not included)
- Not recommended to use under the age of 3 due to the swallowable small parts!
- The LEDs can not be replaced in the luminaire!



NLH 1

- hippopotamus
- size: cca. 35 x 19 x 20 cm



NLM 1

- monkey
- pleasant lullaby (individually switchable)
- automatically turns off after approx. 50 minutes
- size: 29 x 17 x 18 cm



NLTG 1

- tiger
- size: cca. 34 x 20 x 18 cm

NLO 5 Nightlight, oceanarium



- projects the seaworld onto the walls and ceiling
- selectable fixed color light or color changing mode
- helps children to fall asleep at night
- 3 in 1: decoration, nightlight and relaxation
- energy saving and safe LED technology
- power supply: 3 x AA (1,5 V) battery (not included)
- light source: 3,8 V / 0,3 A / E10 bulb + 3 x Ø5 mm LED
- can be powered by mains adapter eg. MW 3N6 (not included)
- size: Ø11 x 12 cm



GL KID

LED lamp for kids

- 3in1: portable/desktop/can be stick to flat surface
- energy saving and safe LED technology
- power supply: 3 x AAA (1,5V) batteries, not included
- size: 7-8 x 8,3-10,3 cm
- 10 pcs/display

We are distributing this product only in display and with mixed figures!



CL 7L SERIES

Portable LED lantern



- 3in1: hand / desk / hanging design
- 7x white DIP LED
- energy saving and safe LED technology
- portable, battery operated
- protected against splashing water (IP44)
- power supply: 4 x AA (1,5 V) batteries, not included
- size: Ø110 x 170 mm



CL 7L/YE

- yellow

CL 7L/RD

- red

CL 7L/GR

- green

CL 5CL

Colour desk LED lamp

- 2in1: flashlight or desk mood light
- with 4 changeable lenses, 5 different colours
- energy saving and safe LED technology
- portable, battery operated
- protected against splashing water (IP44)
- power supply: 3 x AAA (1,5 V), not included
- size: Ø110 x 150 mm



SLF SERIES

Selfie stick

- the newest design, a groove prevents the device from unwanted rotation
- connection to the phone with 3,5 mm headphone plug
- usable with 55-80 mm wide phones, with a limit of 300 grams
- extendable: max. 52 cm



SLF 52/F

SLF 52/B

DL 210L

LED disco globe with 2 x 10 cm mirror balls



- real glass mirror balls with 3D rotation
 - constantly changing colours and graphic projections
 - ideal for larger rooms as well (cca. 100 m²)
 - energy saving and safe LED technology
 - 32 pcs of built-in coloured LEDs
 - power supply 12 V~ adapter, included
 - size: 26 x 20,5 x 16 cm
- This product is not suitable for household lighting, only usable for producing light effects. The LED light sources in the luminaire are not replaceable!



DL 80L

LED disco light



- rotating, shining crystal globe
 - continuously changing symbol projection
 - ideal for larger rooms as well (cca. 100 m²)
 - can be mounted on wall or furniture
 - energy saving and safe LED technology
 - 6 pcs of built-in, coloured LEDs (blue-green-red)
 - power supply: 3 x AA (1,5 V) batteries (not included)
 - size: Ø9,2 x 8,5 cm
- This product is not suitable for household lighting, only usable for producing light effects. The LED light sources in the luminaire are not replaceable!



DL 6BT

Disco light and multimedia player



- wireless BT connection
- connectable to mobile phones, computers...
- playing MP3 files from USB/microSD storage
- FM radio, with 35 programmes, and automatic tuning
- AUX wired stereo audio input
- EQ equalizer
- 2+2 built-in speakers and XTRA BASS
- multimedia player with or without light-effect function
- continuously changing colour and symbol projection
- selectable light-effect functions
- energy saving and safe LED technology
- ideal for larger rooms as well (cca. 100 m²)
- portable, 3 ways to be placed
- mountable to the ceiling or onto side wall
- accessories: remote control, microUSB-USB power cable, 3,5 mm AUX audio cable
- power supply: replaceable Li-ion accumulator (3,7 V / 1800 mAh)
- size: Ø18 x 16 cm

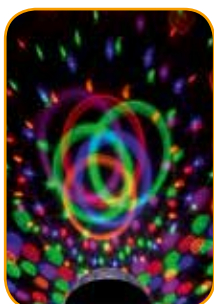

DL 27 Disco globe**E14**

- continuously rotating disco globe
- ideal for larger rooms
- up to approx. 80-100 m²
- the light source is easily replaceable
- 40 W / E14 candle bulb
- the bulb included in the packing is only to test the product
- 230 V~ / 50 Hz
- size: Ø28,5 x 40 cm
- size of the ball: Ø27 cm

**DL 3/27RGB**

LED disco globe

360°**E27**

- 360 degree rotary glass
 - projection of continuously changing figures
 - ideal for larger rooms as well (cca. 50 m²)
 - energy saving POWER LED technology
 - 3 x 1 W red, green, blue LED light source
 - size: Ø8 x 15 cm
- This product is not suitable for household lighting, only usable for producing light effects.
The LED light sources in the luminaire are not replaceable!

**DL IP 2** LED party light projector

- projects moving, coloured rings to the wall
- 3 pcs of bright colored LEDs
- can be stuck into the ground or mountable to the wall
- adjustable projecting angle
- plastic housing
- included IP44 outdoor adaptor

**DL MSC**

LED disco light projector



- projects continuously changing figures
- red and green laser light
- whirling figures and strobe effect
- controllable speed
- ideal for larger rooms as well (cca. 400 m²)
- follows the beat using its built-in microphones
- universal, three-way placement
- can be mounted to the ceiling or side wall
- included tabletop stand
- power supplied by adapter (included, 230 V~ / 5 V / 1,5 A)
- size: 12 x 9,2 x 51 cm
- **LASER RADIATION! DO NOT STARE INTO THE LASER BEAM!**
- class 2 laser product, wavelength: 532/650 nm, max. output: 1 mW

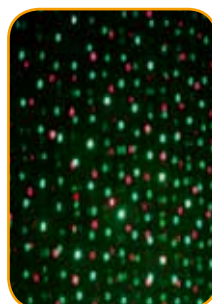

LASER RADIATION!
DO NOT STARE INTO THE LASER BEAM!
CLASS 2 LASER PRODUCT
 $\lambda = 650 \text{ nm } P \leq 1 \text{ mW} / \lambda = 532 \text{ nm } P \leq 1 \text{ mW}$
MSZ EN 60825-1:2008

PNL HRT

- heart shape

Motion sensing mini LED lamp

You can find everything quickly in your bag thenceforth!

- developed specially for handbags
- it will switch on automatically by opening the bag or by hand movements
- it will light 15 seconds more after the moving is finished
- operation range c.a. 60 cm / 45°
- ideal for suitcase, jewellery box, drawer, self, vehicle glove box
- hanging or clipped design
- bright white light, 2 pcs SMD LEDs + PIR infra sensor
- battery lifespan: c.a. 3.000 occasion
- LED light sources in the luminaire are not replaceable!
- power supply: 2 x CR2032 (3V) button battery, included
- size: 4,2 x 2,2 cm

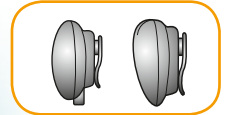

PNL RND

- round shape

PNL 4

LED desk lamp with motion detector



- plastic luminaire and light glass
- 6 pcs of warm white + 6 pcs of cold white LEDs
- PIR motion-sensor
- detection angle: horizontally 110°, vertically 90°
- detection distance: cca. 3 m
- modes: warm white, OFF, cold white, PIR
- in dark, if PIR mode is used and it's sensing movement the lamp turns on for 60 seconds
- can be used as a desktop lamp or can be hung
- power supply: 4 x C (1,5 V) batteries (not included)
- size: Ø16 x 23,6 cm



cool
white
LEDs



warm
white
LEDs



PNL 3/WH

Rotating LED light with motion detector



- 3 x 0,3 W cold white SMD LED
- with PIR motion detector
- detection angle: 110°
- detection distance: cca. 4 m
- modes: ON, OFF, AUTO
- in dark, if AUTO mode is used and it's sensing movement the lamp turns on for 15 seconds
- can be used as tabletop, wall-mounted or flashlight
- included fastening screws and double-sided adhesive tape
- power supply: 3 x AA (1,5 V) batteries (not included)
- size: Ø11,5 x 11 cm



PNL 2

Multi-purpose LED light with motion detector



- 6 x 0,1 W cold white DIP LEDs
- with PIR motion detector
- detection angle: horizontally 120° x 100°
- detection distance: cca. 3 m
- in dark, if AUTO mode is used and it's sensing movement the lamp turns on for 50 seconds
- power supply: 3 x AA (1,5 V) batteries (not included)
- size: Ø9 x 4,2 cm



PNL 1

Multi-purpose LED light with motion detector



- 3 x 0,1 W cold white DIP LEDs
- with PIR motion detector
- detection angle: 120° x 80°
- detection distance: kb. 5 m
- in dark, if AUTO mode is used and it's sensing movement the lamp turns on for 30 seconds
- power supply: 3 x AA (1,5 V) batteries (not included)
- size: 6,5 x 8 x 4 cm



SLL 600**LED spotlight, with light detector**

- plastic luminaire and lampshade
- 6 pcs of cold white SMD LEDs
- the brightness increasing as the ambient light decreases
- power supply: 230 V~ / 50 Hz / 0,6 W
- size: 5,8 x 11,5 x 2,5 cm

**SLL 500****LED spotlight, with light detector**

- 230 V~ / 50 Hz / 0,7 W
- 5 pcs of long-life LEDs
- automatic power on/off
- automatic brightness adjustment
- for indoor use
- very low consumption
- size: 4,5 x 11,5 x 4 cm

**LNL 600****LED spotlight, with switch**

- plastic luminaire and lampshade
- 6 pcs of cold white SMD LEDs
- with on/off switch
- power supply: 230 V~ / 50 Hz / 0,6 W
- size: 7 x 9 x 4 cm

**LNL 500****LED spotlight, with switch**

- 230 V~ / 50 Hz / 0,7 W
- 5 pcs of long-life LEDs
- very low consumption
- for indoor use
- size: 4,5 x 11,5 x 4 cm

**LNL 120****LED spotlight, with switch**

- 230 V~ / 50 Hz / 0,7 W
- 3 pcs of long-life LEDs
- very low consumption
- for indoor use
- size: 7 x 6,7 x 2,5 cm

**SNL 320****Spotlight with light sensor**

- 230 V~ / 5 W consumption
- 1 pc of replaceable fluorescent lamp - E14
- automatic power on/off
- for indoor use
- size: 3,5 x 11 x 3,7 cm

**NL 120****Spotlight with light switch**

- 1 pc of mini fluorescent lamp
- high brightness
- long life
- for indoor use
- size: 6,5 x 1,5 x 6 cm

**SNL 300/T****Bulb**

- 2 pcs/pack
- 230 V~ / 7 W
- E14 socket
- energy class: F
- size: Ø2,5 x 5,5 cm



CL 2L Portable LED camping lantern



- 3in1: hand / desk / hanging design
- 1x white SMD LED & 1x red SMD LED
- red light doesn't disturb most of the animal
- popular for fishermen and hunters
- energy saving and safe LED technology
- portable, battery operated
- protected against splashing water (IP44)
- The LED light sources in the luminaire are not replaceable!
- power supply: 4 x AA (1,5 V) batteries, not included
- size: Ø110 x 170 mm



CL 4+1L LED camping lamp



- professional materials and design
- protected against splashing water (IPX4)
- 4 pcs of white SMD LEDs: selectable 3 brightness modes
- 1 pc of red LED: selectable continuous or SOS emergency light
- fold-up metal carbiner on the top and bottom on the lamp
- can be hung on the desktop with the rubberized carrier grip
- can be used as overhead light (eg. in a tent) after the removal of the shell
- illuminated pushbutton indicates battery charge status (green, yellow, red, flashing red)
- operating time with white LEDs cca. 6 hours; with red LEDs cca. 168 hours
- power supply: 3 x D [1,5 V] batteries (not included)
- size: Ø8,6 x 19 cm



CL 16L LED camping lamp



- 16 LEDs
- rotating knob modes: off / on / brightness control
- fold-up carrying handle
- power supply: 3 x AA [1,5 V] batteries (not included)
- size: Ø10 x 17,5 cm



CL 36L LED camping lamp



- 36 LEDs
- 2 different functions: 18 LEDs, 36 LEDs
- built-in accumulator, 2 possible charging manner: dynamo, adapter
- massive, detachable carrying handle
- protected against splashing water (IP54)
- power supply: 3 x AA [1,2 V] built-in accumulator (included) 230 VAC / 5 V 1000 mA DC adapter (included)
- size: 12,5 x 26 x 12,5 cm



PLZ 1/BK**LED cord lamp**

- black



- for indoor use
- turn on/off by pulling the cord
- 1 pc of Ø8 mm warm white LED
- length of cord: 100 cm
- size of the lamp: Ø5,5 x 15,5 cm
- power supply: 3 x 1,5 V (AAA) batteries, not included

ON/OFF

**PLZ 1/WH**

- white

GL 48**LED flashlight**

- 48 LEDs
- special LED light source with high brightness and low consumption
- 3 different functions: 24 LEDs lit up in the outer row, 24 LEDs lit up in the inner row, 48 LEDs lit up
- massive plastic housing
- two ways of mounting: magnetic and hanging
- power supply: 3 x AA [1,5 V] batteries (not included)
- size: Ø13,5 x 1,5 cm

**GL 4L****LED flashlight**

- 3in1: hand / desk / furniture lamp
 - rotatable in 360 degrees, 4 pcs of high brightness LEDs
 - massive and elegant aluminium luminaire
 - energy saving and safe LED technology
 - base is standable, stickable and magnetically fixable
 - power supply: 3 x AAA (1,5 V) batteries, not included
 - size: 5,5 x 23 cm
- The LED light sources in the luminaire are not replaceable!

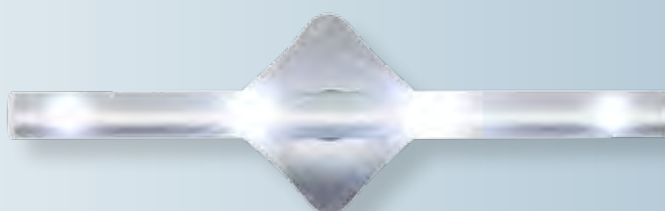
**GL 03****LED furniture lighting**

- 3 pcs of cold white LEDs
- can be turned on and off by pushing the lamp shade
- massive plastic housing, with self-adhesive surface
- power supply: 3 x 1,5 V (AAA) batteries (not included)
- size: Ø7 x 2,5 cm

**GL 04N****LED furniture lighting**

- 4 pcs of cold white LEDs
- can be turned on and off by pushing the lamp shade
- massive plastic housing, with self-adhesive surface
- power supply: 3 x 1,5 V (AAA) batteries (not included)
- size: 10 x 4 x 2,3 cm



MFL 06 LED metal flashlight

4 W
CREE LED

3
function

- high brightness CREE LED
- 3 functions: high and low brightness, flashing
- durable metal lamp body
- ergonomically designed handle
- power supply: 3 x 1,5 V (AA) batteries, not included
- size: 16 x 9 x 6,2 cm



MFL 05 LED metal flashlight

METAL

3 W
CREE LED

- durable metal lamp body
- high brightness 3 W CREE LED
- 3 functions: high and low brightness, flashing
- lens can be focused
- with wrist strap and fabric pouch
- power supply: 3 x 1,5 V (AAA) batteries, included
- size: Ø3,5 x 12 cm



MFL 02 LED metal flashlight with pointer

METAL

DIP
LED



- 8 LEDs
- electronic programming: 8 LEDs / pointer
- massive metal housing
- power supply: 3 x AAA [1,5 V] batteries (not included)
- size: Ø2,5 x 11 cm
- LASER RADIATION! DO NOT STARE DIRECTLY TO THE BEAM!
CLASS 2 LASER PRODUCT!
WAVELENGTH: 650 nm • MAX. OUTPUT: 1 mW



MFL 03 LED metal flashlight

METAL

DIP
LED

- 28 LEDs
- massive metal housing
- power supply: 3 x AAA [1,5 V] batteries (not included)
- size: Ø2,5 (Ø4,5) x 12 cm



MFL 04 LED metal flashlight

METAL

DIP
LED

- 3 LEDs
- special LED light source with high brightness and low consumption
- massive metal housing
- power supply: 2 x AA [1,5 V] batteries (not included)
- size: Ø2,7 x 15 cm



MFL 023 LED metal flashlight

METAL

DIP
LED

- 5 LEDs
- special LED light source with high brightness and low consumption
- metal housing with anti-slip grip end
- accessory: hanger ring
- power supply: 3 x LR44 [1,5 V] batteries (not included)
- size: Ø1,8 x 6,7 cm



MFL 10 LED metal flashlight

METAL

DIP
LED

- 9 LEDs
- massive camouflage metal housing
- perfect for camping, fishing, hunting
- power supply: 3 x AAA [1,5 V] batteries (not included)
- size: Ø2,7 x 9 cm



PLR 04 Rubbered LED flashlight



- IP66 protected against powerful water jets
- it floats on the water surface even with batteries
- 3 pcs of bright LEDs
- 2 x AA [1,5 V] batteries (not included)
- size: Ø5,5 x 18 cm



PLR 01 Waterproof flashlight



- Krypton bulb
- 2 x AA [1,5 V] batteries (not included)
- size: Ø40 x 15 cm



PLR 02 Waterproof flashlight



- Krypton bulb
- 2 x D [1,5 V] batteries (not included)
- size: Ø6,5 x 20,5 cm



PLR 03 Waterproof flashlight



- Krypton bulb
- 3 x D [1,5 V] batteries (not included)
- size: Ø6,5 x 26,5 cm



OL 5 LED LED metal flashlight



- 5 LEDs
- with on/off switch
- can be placed onto a horizontal surface or hanged
- battery converter included (3 x AA → 3R12)
- power supply: 3 x AA batteries, or 3R12 flat battery (not included)
- size: 7 x 11 x 3,5 cm



OL 100 LED metal flashlight



- Krypton bulb
- 1 x 3R12 [4,5 V] battery (not included)
- size: 7 x 11 x 3,5 cm



USB LED SERIES Flexible LED light with USB connection



- illuminates the environment at home, during travelling and at work
- ideal to illuminate the keyboard of notebooks
- can be used as a nightlight, emergency light...
- totally closed housing with metal cooling surface
- 6 pcs of very bright, white SMD LEDs
- it has soft surface so it won't scratch the devices
- 6 x SMD LEDs / 1,2 W / USB 5V / 210 mA
- size: 17 x 1,8 x 0,9 cm

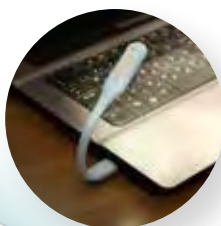

DFL 02 LED lamp with dynamo



- 3 LEDs
- special LED light source with high brightness and low consumption
- massive plastic housing
- with 1 minute of manual charging it can light for 30 minutes with 1 LED, and 15 minutes with 3 LEDs
- power supply: 1 x LIR 2032 [3,6 V] built-in accumulator
- size: 5 x 5 x 13,5 cm

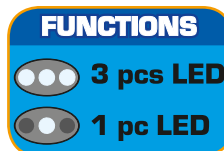

USB LED/BK

USB LED/WH

- black

- white

HLP 4 LED headlamp

3 W
COB LED

120 lm

2 function

- durable plastic lamp body
- comfortable, elastic rubber headband
- tiltable lamp head
- adjustable brightness (50%, 100%)
- power supply: 3 x 1,5 V (AAA) batteries (not included)



HLM 3W LED headlamp

3W CREE LED

SPEED FOCUS

- durable metal lamp body
- high brightness 3 W CREE LED
- 3 functions: high and low brightness, flashing
- lens can be focused
- power supply: 3 x 1,5 V (AAA) batteries (not included)
- size: 6 x 7 x 4,5 cm



PLF 19 LED headlamp

DIP LED

- 19 LEDs
- 4 different functions: 1 LED / 7 LEDs / 19 LEDs / 19s LEDs flashing
- long life
- adjustable tilt: 135°
- waterproof exterior
- power supply: 3 x AAA [1,5 V] batteries (not included)
- size: 7 x 5,5 x 7 cm



HLP 3W+4L LED headlamp

3W CREE LED

- 1 pc of bright 3 W CREE LED
- 2 pcs of white + 2 pcs of flashing red LEDs
- 3 functions: high and low brightness, flashing red light
- power supply: 3 x 1,5 V (AAA) batteries (not included)
- size: 6 x 4 x 3,5 cm



PLF 12 LED headlamp

DIP LED

- 12 LEDs
- 4 different functions: 4 LEDs / 8 LEDs / 12 LEDs / 12 LEDs flashing
- long life
- adjustable tilt: 135°
- waterproof design
- power supply: 3 x AAA [1,5 V] batteries (not included)
- size: 7 x 5,5 x 7 cm



HLP 5+4L LED headlamp

DIP LED

- 3 functions: white light, red light and red flashing light
- 5 pcs of white LEDs: continuous light
- 4 pcs of red LEDs: continuous or flashing light
- power supply: 3 x 1,5 V (AAA) batteries (not included)
- size: 6 x 4 cm



PLF 7 LED headlamp

DIP LED

- 7 LEDs
- 3 different functions: 1LED/3LEDs/7LEDs
- long life
- adjustable tilt: 135°
- waterproof design
- power supply: 3 x AAA (1,5 V) batteries (not included)
- size: 7 x 5,5 x 7 cm





BV 14/RD LED bicycle lamp

- red



- Be safe! Be visible!
- rechargeable
 - can be fixed with the included elastic band (2 sizes)
 - for Ø12-32 mm handlebar
 - flashing (8h), and steady (4h) light functions
 - 5 SMD LEDs
 - wide lighting angle
 - red, charging indicator light
 - microUSB charger socket (2h)
 - accessory: power cable USB - microUSB, 20 cm
 - size: 72 x 20 x 20 mm

BVF 16 LED bicycle lamp set

- Be safe! Be visible!
- lamp body can be fixed with rubber band
 - 1 pc of bright red or white LED
 - flashing and steady light functions
 - weather resistant design
 - power supply: front light: 2 x CR1220 button batteries (included); rear light: 1 x CR1220 button batteries (included)
 - size: Ø40 x 20 mm



BV 14/WH

- white

BV 11 LED bicycle lamp set

- Be safe! Be visible!
- elastic, silicon luminaire
 - 2 pcs of bright red or white LEDs
 - short and fast flashing, steady light function
 - weather resistant design
 - power supply in each lamp: 2 x 3 V (CR 2032) batteries (included)
 - size: 30 x 30 x 40 mm



BV 10



BV 13 LED bicycle lamp set



Be safe! Be visible!
 - lamp body can be fixed with clamps
 - flashing and steady light functions
 - weather resistant design
 - power supply: front lamp: 4 x 1,5 V (AAA) batteries, not included; rear lamp: 2 x 1,5 V (AAA) batteries, not included
 - size: front: Ø3 x 10 cm; rear: 3,8 x 6,5 x 3 cm



BV 15 LED clip-on lamp

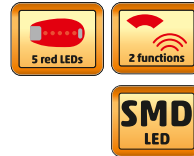

Be safe! Be visible!
 - lamp body can be fixed with clips
 - 5 pcs of red SMD LEDs
 - flashing and steady light functions
 - steady light: max. 72 hours, flashing light max. 96 hours
 - power supply: 2 x 3V (CR2032) button batteries, included
 - sized: 57 x 28 x 20 mm



FB 2 LED/BL LED arm band

blue material
 - flexible silicon lamp body
 - 2 LEDs with bright light
 - flashing and steady light functions
 - weather resistant design
 - size: 37 x 13 x 190 mm



FB 2 LED/YE

- yellow material



SA 059 Mobile phone holder for bicycles

- protect the phone from dust, wet and shock
 - the phone can be operated through the foil
 - earphone wire can be led out comfortably
 - easy to put on and take off
 - recommended screen diagonal: 4,2...5,5"
 - size of phone compartment: kb. 95 x 170 mm
 - outer size: cca. 105 x 100 x 200 mm





WL 27A LED worklamp



- suitable to illuminate small, hardly visible places
 - huge brightness, with 27 pcs of LEDs
 - rechargeable accumulator with constant 4-5 hours of work
 - can be fixed with hook or magnet
 - handy, rubberised grip
 - power supply: accumulator: 4,8 V / 1200 mAh (included);
accumulator charger: 230 V~ / 50 Hz (included);
car charger: 12 V (included)
 - size: Ø6 x 39 cm
- The LEDs are built into the luminaire and are not replaceable.
Energy class: A.



WL 60H LED worklamp



- suitable to illuminate small, hardly visible places
 - huge brightness, with 60 pcs of LEDs
 - can be hooked
 - with dust and damp resistant switch
 - handy grip
 - 5 m power cable
 - power supply: 230 V~ / 50 Hz / 3,6 W
 - size: Ø6 x 43 cm
- The LEDs are built into the luminaire and are not replaceable.
Energy class: A.



WL 3W+7L

Rechargeable LED worklamp



- 1 pc of 3 W COB LED + 7 pcs of white LEDs
- robust ABS luminaire
- soft-touch surface
- adjustable lamp head (180°)
- 3 switchable modes (30%, 100% COB LED; 7 LEDs)
- rechargeable Li-Ion accumulator 3,6 V - 1600 mAh
- rechargeable with adapter or 12 V vehicle charger adapter
- strong magnets on the back and base of the luminaire
- practical hinged hanging hooks
- size: 2,8 x 5,5 x 3,5 cm



MAGNETIC



WL 06 LED worklamp

3 W
COB LED

4 white LEDs

150 lm

MAGNET

- 1 x 3 W COB LED + 4 pcs of white LEDs
- robust ABS luminaire
- soft-touch surface
- adjustable lamp head (180°)
- 3 switchable modes (30%, 100% COB LED; 4 LED)
- strong magnet on the base of the lamp
- practical hinged hanging hooks
- power supply: 3 x 1,5V (AAA) batteries, not included
- size: 55 x 30 x 218 mm



WL 07 LED worklamp

3 W
COB LED

4 white LEDs

150 lm

MAGNET

2 functions

- 1 x 3 W COB LED + 4 pcs of white LEDs
- robust ABS luminaire
- soft-touch surface
- 2 switchable modes: (COB LED, 4 LED)
- strong magnet on the back of the lamp
- power supply: 4 x 1,5 V (AAA) batteries, not included
- size: 195 x 60 x 33 mm



Can be ordered only in display!

PL 15+1L LED worklamp

DIP LED

- 15 pcs of white LEDs: lights up when unfolded from the plastic case
- 1 front white LED: lights up when the button is kept pressed
- luminaire can be set in several positions when unfolded from case
- easy to handle and can be suspended using wrist band
- can be affixed magnetically
- power supply: 3 x 1,5 V (AAA) batteries (not included)
- size: 10,58 x 4 x 3 cm



PL 9L LED pen-light, with pointer

SMD LED

- the light sources can not be replaced
- magnetic, rotatable clip
- power supply: 3 x AAA (1,5 V) batteries (not included)
- size: 6,5 x 3,5 x 2 cm



LASER RADIATION!
DO NOT STARE INTO THE LASER BEAM!
CLASS 2 LASER PRODUCT
 $\lambda = 650 \text{ nm } P \leq 1 \text{ mW} / \lambda = 532 \text{ nm } P \leq 1 \text{ mW}$
MSZ EN 60825-1:2008

WL 5-8 Worklamp

IP44

- power saving, long lasting fluorescent lamp
 - safe: resists shock and outer damage
 - 5 m rubber cable
 - power supply: 230 V~ / 50 Hz / 8 W
 - size: $\varnothing 3 \times 41 \text{ cm}$
- The luminaire has got built-in light sources which are not replaceable.
Energy class: A



PL 20 Worklamp

IP44

- for outdoor use
 - rubberized handle
 - massive metal grill and hanging hook
 - thick glass shade
 - double insulation
 - 5 m rubber cable
 - porcelain socket
 - light source: max. 60 W / E27 (not included)
 - power supply: 230 V~ / 50 Hz
 - size: $\varnothing 11 \times 28 \text{ cm}$
- The luminaire can operate with the following energy class light sources: A++, A+, A, B, C, D, E



NKLL 05 Magnifying LED lamp

540 lm **DIP LED**

- table top mountable
 - 90 pcs of DIP LEDs, cold white (4200 K)
 - 540 lumen brightness
 - Ø125 mm magnifying lens
 - magnification: 3 dioptries
 - folding, scratch protection cover
 - length of power cable: 1,5 m
 - power supply: 230 V~ / 50 Hz / 6,6 W
 - option: 5 dioptries lens (NKL 5D)
 - size of head part: 200 x 40 x 260 mm
 - length of lamp shafts: 410 mm (x 2 pcs)
- The luminaire contains built-in LED lamps.
The light sources can not be replaced.
Energy class: A+



NKLL 04 Magnifying LED lamp

360 lm **DIP LED**

- base can be placed onto desktop
 - 60 pcs of DIP LEDs, cold white (4200 K)
 - 360 lumen brightness
 - exclusive plastic luminaire
 - Ø90 mm magnifying lens
 - magnification: 3 dioptries
 - secondary lens: 12 dioptries
 - folding, scratch protection cover
 - length of power cable: 1,5 m
 - power supply: 230 V~ / 50 Hz / 4,4 W
 - size of base: 175 x 150 mm
 - height of luminaire: ~ 370 mm (max. 470 mm)
- The luminaire contains built-in LED lamps.
The light sources can not be replaced.
Energy class: A+



NKL 022 Magnifying lamp

550 lm

- base can be placed onto desktop
 - Ø90 mm glass magnifying lens
 - magnification: 3 dioptries
 - secondary lens: 12 dioptries
 - circular fluorescent lamp: Ø115 mm / 12 W
 - folding, scratch protection cover
 - 1,5 m power cable
 - power supply: 230 V~ / 50 Hz / 12 W
 - size: head: 14 x 18 cm, shaft: 22 cm, base: 21 x 11 x 10 cm
 - option: replacement fluorescent lamp (NKL 022F)
- The energy class of the circular fluorescent lamp sold with the luminaire: B.
The luminaire can operate with the following energy class circular fluorescent lamps: A, B, C, D, E.

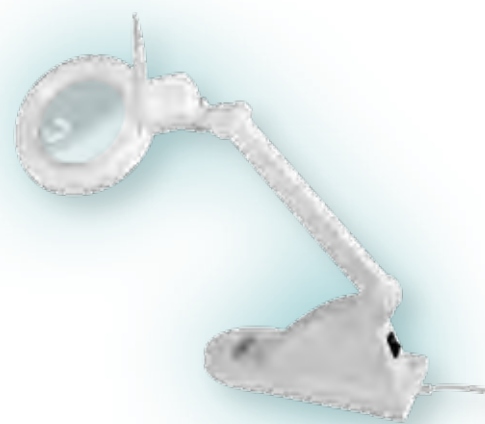

NKL 022F Replacement fluorescent lamp for NKL 022

- suitable for the most magnifying lamps (recommended for NKL 022 marketed by SOMOGYI ELEKTRONIC)



NKLF Replacement fluorescent lamp for NKL 03

- suitable for the most magnifying lamps



NKLF T5 Replacement fluorescent lamp for NKL 01

- suitable for the most magnifying lamps (recommended for NKL 01 marketed by SOMOGYI ELEKTRONIC)



type	output	flux	colour temperature	size	energy class	weighted energy consumption
NKL 022F	12 W	550 lm	6400 K	Ø115 mm / T4	B	12 kWh / 1000 h
NKLF	22 W	1050 lm	6400 K	Ø205 mm / T8	B	22 kWh / 1000 h
NKLF T5	22 W	1250 lm	6400 K	Ø184 mm / T5	B	22 kWh / 1000 h

NKL 01 Magnifying lamp

1250
lm

- can be mounted onto desktop
 - Ø125 mm glass magnifying lens
 - magnification: 3 dioptries
 - circular fluorescent lamp: Ø184 mm / T5 22 W
 - folding, scratch protection cover
 - 1,7 m power cable
 - power supply: 230 V ~ / 50 Hz / 22 W
 - size: head: 20 x 26,5 cm, shaft: 2 x 40 cm
 - option: 5 dioptries lens (NKL 5D), replacement fluorescent lamp (NKLF T5)
- The energy class of the circular fluorescent lamp sold with the luminaire: B.
The luminaire can operate with the following energy class circular fluorescent lamps: A, B, C, D, E.

NKL 03

Magnifying lamp, with stand

- NKL 01**
Magnifying desktop lamp
+ NKLA
Magnifying lamp stand



NKLA Magnifying lamp stand

- suitable for NKL 01 and NKLL 05 desktop magnifying lamps
- height/width: 78/56 cm
- weight in the base of the luminaire: 5,5 kg
- size of shaft can be inserted: max. Ø12,8 mm, fixing by screw
- total weight: 7,8 kg

NKL 3D Replacement lens

- Ø125 mm glass magnifying lens
- suitable for most magnifying lamps
- recommended for the following products, marketed by SOMOGYI ELEKTRONIC: NKL 01, NKLL 05
- magnification: 1,75 x (3 dioptries)

NKL 5D Replacement lens

- Ø125 mm glass magnifying lens
- magnification: 2,25 x (5 dioptries)
- suitable for most magnifying lamps
- recommended for the following products, marketed by SOMOGYI ELEKTRONIC: NKL 01, NKLL 05



FLB 20 LED/YE**Rechargeable LED floodlight**

1600
lm
20 Watt



5000 K

- portable, for outdoor and indoor use
 - 20 W chip LED
 - accumulator: 2 x Li-ion 18650 / 7,4V / 2 x 2200 mAh (not replaceable)
 - operating (lighting) time: max. 3 h
 - charging time: 4-5 h
 - adapter included: PRI: 230 V~ / 50 Hz
SEC: 8,4 V === / 1000 mA
 - cigarette-lighting socket adapter included:
PRI: 12-24 V === SEC: 8,4 V === / 1000 mA
 - length of charging cables: 100 cm
- The luminaire contains built-in LEDs.
The light source can not be replaced.
Energy class: A

**FLB 10 LED/YE****Rechargeable LED floodlight**

800 lm
10 Watt



5000 K

- portable, for outdoor and indoor use
 - 10 W chip LED
 - accumulator: Li-ion 18650 / 3,7V / 2000 mAh (not replaceable)
 - operating (lighting) time: max. 3 h
 - charging time: 4-5 h
 - adapter included:
PRI: 230 V~ / 50 Hz SEC: 5 V === / 500 mA
 - cigarette-lighting socket adapter included:
PRI: 12-24 V === SEC: 5 V === / 2600 mA
 - length of charging cables: 70 cm
- The luminaire contains built-in LEDs.
The light source can not be replaced.
Energy class: A+

**FL 20 LED****LED floodlight**

1600
lm
20 Watt



4500 K

- wall mountable
 - for outdoor and indoor use
 - 20 W chip LED
 - power supply: 230 V~ / 50 Hz
 - size: 15,5 x 18,5 x 12,3 cm
- The luminaire contains built-in LEDs.
The light source can not be replaced.
Energy class: A

**FL 10 LED****LED floodlight**

800 lm
10 Watt



4500 K

- wall mountable
 - for outdoor and indoor use
 - 10 W chip LED
 - power supply: 230 V~ / 50 Hz
 - size: 11,5 x 13,5 x 9,7 cm
- The luminaire contains built-in LEDs.
The light source can not be replaced.
Energy class: A+

**FLST 20****Carrying frame
for 20 W LED floodlight**

It may only be used for floodlights, equipped
with connection plug!

- size: 240 x 220 x 290 mm

**FLST 10****Carrying frame
for 10 W LED floodlight**

It may only be used for floodlights, equipped
with connection plug!

- size: 205 x 190 x 260 mm



FLP 6 SOLAR

LED floodlight with solar panel and motion sensor

300 lm
6 Watt

IP44

METAL

-10°C
+40°C

- aluminium, rotatable, tiltable lamp head
 - output: 6 W (12 x 0,5 W, 5050 SMD LED)
 - brightness: 300 lumen, cold white
 - accumulator: 2 x 2000 mAh (Li-ion 18650 / 3,7 V)
 - swivel connector cable: 2,35 m
 - PIR motion sensor
- The luminaire contains built-in LEDs.
The light sources can not be replaced.



6916H

LED floodlight with solar panel and motion sensor

96 lm

IP44

- output: 2 x 0,5 W SAMSUNG SMD LEDs
 - brightness: 96 lm, cold white
 - power supply: NiMH 600 mAh / 3,6 V
 - wire: 5 m
 - PIR motion sensor
- The luminaire contains built-in LEDs.
The light sources can not be replaced.



floodlight with motion sensor

FLP 500/BK**Halogen floodlight, with motion sensor**

- black



- automatically turns on when motion is detected, depending on the light conditions
- controllable operating time: 10 sec. - 7 min.
- outdoor design (IP44 protection)
- detection angle: 180°
- adjustable detection distance: 5 - 12 m
- robust aluminium housing
- tempered, heat proof glass front panel
- the luminaire works with light bulbs of the following energy rating: C, D, E (max. 500 W)
- halogen light tube, 400 W, R7s, C energy class, 2000 h, 118 mm (included)
- size of the housing: 185 x 145 x 113 mm

230 V~ / 400 W

**FLP 500/WH**

- white

FLP 150/BK**Halogen floodlight, with motion sensor**

- black



- automatically turns on when motion is detected, depending on the light conditions
- controllable operating time: 10 sec. - 7 min.
- outdoor design (IP44 protection)
- detection angle: 180°
- adjustable detection distance: 5 - 12 m
- robust aluminium housing
- tempered, heat proof glass front panel
- the luminaire works with light bulbs of the following energy rating: C, D, E (max. 150 W)
- halogen light tube, 120 W, R7s, C energy class, 2000 h, 78 mm (included)
- size of the housing: 136 x 95 x 76 mm

230 V~ / 120 W

**FLP 150/WH**

- white

FL 500/BK**Halogen floodlight**

- black



- outdoor design (IP44 protection)
- rotatable base
- robust aluminium housing
- tempered, heat proof glass front panel
- the luminaire works with light bulbs of the following energy rating: C, D, E (max. 500 W)
- halogen light tube, 400 W, R7s, C energy class, 2000 h, 118 mm (included)
- size of the housing: 185 x 145 x 113 mm

230 V~ / 400 W

**FL 500/WH**

- white

FL 150/BK**Halogen floodlight**

- black



- outdoor design (IP44 protection)
- rotatable base
- robust aluminium housing
- tempered, heat proof glass front panel
- the luminaire works with light bulbs of the following energy rating: C, D, E (max. 150 W)
- halogen light tube, 120 W, R7s, C energy class, 2000 h, 78 mm (included)
- size of the housing: 136 x 95 x 76 mm

230 V~ / 120 W

**FL 150/WH**

- white

FLH 500/YE**Portable halogen floodlight**

- outdoor design (IP44)
- safety grid
- robust aluminium housing
- tempered, heat proof glass front panel
- 1,5 m cable
- the luminaire works with light bulbs of the following energy rating: C, D, E (max. 500 W)
- halogen light tube, 400 W, R7s, C energy class, 2000 h, 118 mm (included)
- size of the housing: 185 x 145 x 113 mm

230 V~ / 400 W

**FLH 150/YE****Portable halogen floodlight**

- outdoor design (IP44)
- safety grid
- robust aluminium housing
- tempered, heat proof glass front panel
- 1,5 m cable
- the luminaire works with light bulbs of the following energy rating: C, D, E (max. 150 W)
- halogen light tube, 120 W, R7s, C energy class, 2000 h, 78 mm (included)
- size of the housing: 136 x 95 x 76 mm

230 V~ / 120 W



FLS 2/500

Halogen floodlight with stand



- double brightness
- outdoor design (IP44)
- adjustable stand height: 95 - 200 cm
- cable holder on the stand
- robust aluminium housing
- tempered, heat proof glass front panel
- 2 m cable
- the luminaire works with light bulbs of the following energy rating: C, D, E (max. 500 W)
- halogen light tube, 2 x 400 W, R7s, C energy class, 2000 h, 118 mm (included)
- size of the housing: 185 x 145 x 113 mm

230 V~ / 2 x 400 W

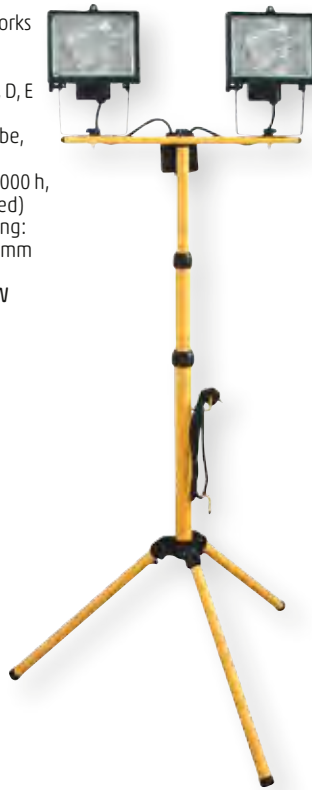

FLS 1/500

Halogen floodlight with stand



- outdoor design (IP44)
- adjustable stand height: 95 - 200 cm
- cable holder on the stand
- robust aluminium housing
- tempered, heat proof glass front panel
- 2 m cable
- the luminaire works with light bulbs of the following energy rating: C, D, E (max. 500 W)
- halogen light tube, 400 W, R7s, C energy class, 2000 h, 118 mm (included)
- size of the housing: 185 x 145 x 113 mm

230 V~ / 400 W



FL 400/T

Halogen bulb

- 220-240 V~ / 400 W / R7s / 2000 h
- for FL 500, FLP 500, FLH 500/YE, FLS 1/500, FLS 2/500 floodlights
- energy class: C
- weighted energy consumption: 400 kWh / 1000 h
- size: Ø10 x 118 mm

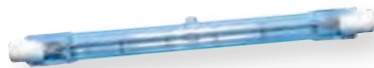

FL 120/T

Halogen bulb

- 220-240 V~ / 120 W / R7s / 2000 h
- for FL 150, FLP 150, FLH 150/YE floodlights
- energy class: C
- weighted energy consumption: 120 kWh / 1000 h
- size: Ø10 x 78 mm



PIR 04/WH

Motion sensor, wall-mountable



- passive infrared (PIR) sensor
- IP44 outdoor construction
- detection angle: 180°
- detection distance: 12 m
- adjustable operating time: 10 sec. - 7 min.
- adjustable light sensitivity: 3 - 2000 LUX
- works in dark and bright
- vertically tiltable
- power supply: 230 V~ / 0,45 W (0,1 W)
- switchable output: 230 V~ / 1200 W
- size: 85 x 85 x 90 mm



PIR 06/WH

Motion sensor 360°, mountable to ceiling

- passive infrared (PIR) sensor
- detection angle: 360°, cone shape (140°)
- detection distance: 6 m
- adjustable operating time: 10 sec. - 7 min.
- adjustable light sensitivity: 3 - 2000 LUX
- works in dark and bright
- power supply: 230 V~ / 0,45 W (0,1 W)
- switchable output: 230 V~ / 1200 W
- size: Ø115 x 55 mm



6982H**LED ceiling light**

- built-in LED light source
 - for indoor use
 - with built-in motion sensor
 - 12 W, 850 lm, 3000 K
 - 230 V~ / 50 Hz
 - Ø260 mm
- The LED light sources can not be replaced in the luminaire.

**7098H****LED ceiling light**

- built-in LED light source
 - IP54 outdoor design
 - 10 W, 750 lm, 3000 K
 - 230 V~ / 50 Hz
 - Ø270 mm
- The LED light sources can not be replaced in the luminaire.

**6921H****Ceiling light (Vega)**

- 230 V~ / max. 100 W
 - white
 - chrysal-like cover
 - outdoor design (IP44 protection)
 - E27 socket
 - size: Ø24 x 9 cm
- The luminaire can work with bulbs with the following energy class: A++, A+, A, B, C, D, E.

**6948H****Ceiling light (Verso)**

- 230 V~ / max. 100 W
 - white
 - chrysal-like cover
 - outdoor design (IP44 protection)
 - E27 socket
 - size: Ø24 x 9 cm
- The luminaire can work with bulbs with the following energy class: A++, A+, A, B, C, D, E.

**6909H****Ship light**

- oval shape, with metal grid
 - 230 V~ / max. 60 W
 - grey
 - outdoor design (IP44 protection)
 - size: 17 x 12,5 x 11 cm
- The luminaire can work with bulbs with the following energy class: A++, A+, A, B, C, D, E.

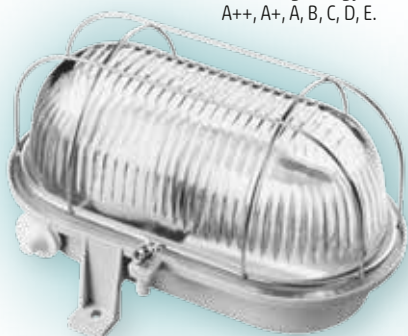
**6915H****Ship light**

- oval shape, with plastic grid
 - 230 V~ / max. 60 W
 - white
 - outdoor design (IP44 protection)
 - size: 17 x 12,5 x 11 cm
- The luminaire can work with bulbs with the following energy class: A++, A+, A, B, C, D, E.

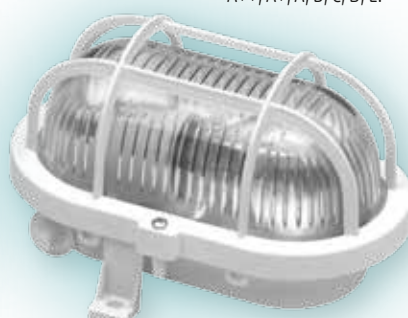
**6914H****Ship light**

- oval shape, with plastic grid
 - 230 V~ / max. 60 W
 - black
 - outdoor design (IP44 protection)
 - size: 17 x 12,5 x 11 cm
- The luminaire can work with bulbs with the following energy class: A++, A+, A, B, C, D, E.



400.041.103 Ceiling light

- maple



BIG SQUARE CLASSIC
 - plastic luminaire and cover
 - can only be used with compact fluorescent lamps (2 x max. 26 W), which has the largest dimension of Ø6 x 16 cm
 - E27 porcelain sockets
 - power supply: 230 V~ / 50 Hz
 - size: 32,3 x 32,3 x 8,9 cm
 The luminaire can work with bulbs with the following energy class: A++/A+/A.



400.011.103

- silver

400.030.103 Ceiling light

- walnut



BIG SQUARE CLASSIC
 - plastic luminaire and cover
 - can only be used with compact fluorescent lamps (2 x max. 26 W), which has the largest dimension of Ø6 x 16 cm
 - E27 porcelain sockets
 - power supply: 230 V~ / 50 Hz
 - size: 32,3 x 32,3 x 8,9 cm
 The luminaire can work with bulbs with the following energy class: A++/A+/A.



400.000.103

- white

400.050.102 Ceiling light



SQUARE CLASSIC
 - plastic luminaire and cover
 - E27 porcelain socket
 - power supply: 230 V~ / 50 Hz / max. 40 W
 - white
 - size: 25,2 x 25,2 x 8,1 cm
 The luminaire can work with bulbs with the following energy class: A++/A+/A/B/C/D/E.



400.021.104 Ceiling light

- gold



BIG UFO ZAGREP
 - plastic luminaire and cover
 - screws and dowels needed to mount the luminaire
 - can only be used with compact fluorescent lamps (2 x max. 26 W), which has the largest dimension of Ø6 x 16 cm
 - E27 porcelain sockets
 - power supply: 230 V~ / 50 Hz
 - size: Ø37,7 x 11,7 cm
 The luminaire can work with bulbs with the following energy class: A++/A+/A.

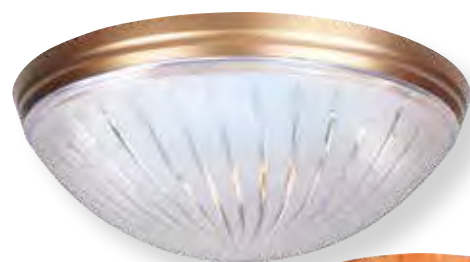

400.041.104

- maple

400.030.104 Ceiling light

- walnut



BIG UFO BULUT
 - plastic luminaire and cover
 - screws and dowels needed to mount the luminaire
 - can only be used with compact fluorescent lamps (2 x max. 26 W), which has the largest dimension of Ø6 x 16 cm
 - E27 porcelain sockets
 - power supply: 230 V~ / 50 Hz
 - size: Ø37,7 x 11,7 cm
 The luminaire can work with bulbs with the following energy class: A++/A+/A.



400.000.104

- white

400.004.101**Ceiling and wall light**

- 5 pcs/pack
- assembly needed

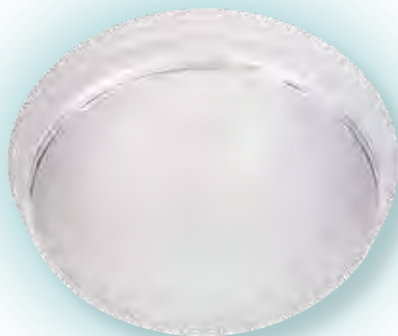

UFO ERCIYES
 - plastic luminaire and cover
 - can only be used with compact fluorescent lamps (max. 15 W), which has the largest dimension of $\varnothing 4 \times 12$ cm
 - E27 porcelain socket
 - power supply: 230 V~ / 50 Hz
 - white
 - size: $\varnothing 23 \times 8,2$ cm
 The luminaire can work with bulbs with the following energy class: A++/A+/A.

**400.004.101/1**

- 1 pc/nylon

400.012.105**Ceiling and wall light**

- grey



AQUA OPAL
 - plastic luminaire and cover
 - protected against water jet (IP65)
 - can be used in sauna
 - E27 porcelain socket
 - power supply: 230 V~ / 50 Hz / max. 60 W
 - size: $\varnothing 27,5 \times 9,9$ cm
 The luminaire can work with bulbs with the following energy class: A++/A+/A/B/C/D/E.

**400.010.105**

- white

400.012.106**Ceiling and wall light**

- grey

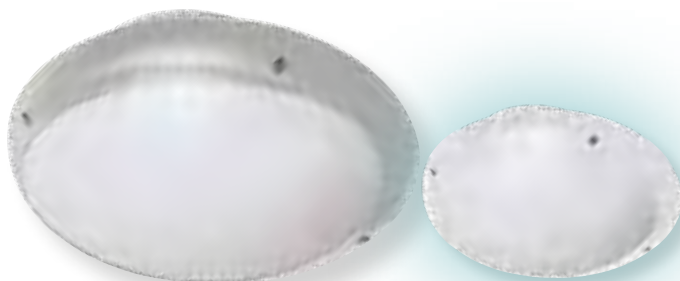

AQUA OVAL OPAL
 - plastic luminaire and cover
 - protected against water jet (IP65)
 - can be used in sauna
 - E27 porcelain socket
 - power supply: 230 V~ / 50 Hz / max. 60 W
 - size: $32,5 \times 23,5 \times 9,8$ cm
 The luminaire can work with bulbs with the following energy class: A++/A+/A/B/C/D/E.

**400.010.106**

- white

400.000.108**Ceiling and wall light**

- black



AQUA ECO
 - plastic luminaire and cover
 - protected against water jet (IP65)
 - can only be used with compact fluorescent lamps (max. 26 W), which has the largest dimension of $\varnothing 6 \times 16$ cm
 - E27 porcelain socket
 - power supply: 230 V~ / 50 Hz
 - size: $\varnothing 22,8 \times 9,7$ cm
 The luminaire can work with bulbs with the following energy class: A++/A+/A.

**400.001.108**

- white

400.013.107**Ceiling and wall light**

- 4 pcs/pack



NINOVA WALL FIXTURE
 - plastic luminaire and cover
 - can only be used with compact fluorescent lamps (max. 26 W), which has the largest dimension of $\varnothing 6 \times 16$ cm
 - E27 porcelain socket
 - power supply: 230 V~ / 50 Hz
 - walnut
 - size: $27 \times 16,5 \times 8,1$ cm
 The luminaire can work with bulbs with the following energy class: A++/A+/A.

**400.013.107/1**

- 1 pc/nylon

400.011.107**Ceiling and wall light**

- 4 pcs/pack



NINOVA WALL FIXTURE
 - plastic luminaire and cover
 - can only be used with compact fluorescent lamps (max. 26 W), which has the largest dimension of $\varnothing 6 \times 16$ cm
 - E27 porcelain socket
 - power supply: 230 V~ / 50 Hz
 - silver
 - size: $27 \times 16,5 \times 8,1$ cm
 The luminaire can work with bulbs with the following energy class: A++/A+/A.

**400.011.107/1**

- 1 pc/nylon

400.003.107

Ceiling and wall light

- 4 pcs/pack
- assembly needed



FLUE
 - plastic luminaire and cover
 - can only be used with compact fluorescent lamps (max. 26 W), which has the largest dimension of Ø6 x 16 cm
 - E27 porcelain socket
 - power supply: 230 V~ / 50 Hz
 - walnut
 - size: 27 x 16,5 x 8,1 cm
 The luminaire can work with bulbs with the following energy class: A++/A+/A.



400.003.107/1

- 1 pc/nylon

400.000.107

Ceiling and wall light

- 4 pcs/pack
- assembly needed



FLUE
 - plastic luminaire and cover
 - can only be used with compact fluorescent lamps (max. 26 W), which has the largest dimension of Ø6 x 16 cm
 - E27 porcelain socket
 - power supply: 230 V~ / 50 Hz
 - white
 - size: 27 x 16,5 x 8,1 cm
 The luminaire can work with bulbs with the following energy class: A++/A+/A.



400.000.107/1

- 1 pc/nylon

400.002.111

Ceiling light

- black



AQUA
 - plastic luminaire and cover
 - protected against splashing water (IP54)
 - can only be used with compact fluorescent lamps (max. 26 W) which has the largest dimension of Ø6 x 16 cm
 - E27 porcelain socket
 - power supply: 230 V~ / 50 Hz
 - size: 24,6 x 14 x 8,5 cm
 The luminaire can work with bulbs with the following energy class: A++/A+/A.



400.000.111

- white



400.000.110

Ceiling light

- 5 pcs/pack
- assembly needed



LOLLY
 - plastic luminaire and cover
 - can only be used with compact fluorescent lamps (max. 15 W), which has the largest dimension of Ø4 x 17 cm
 - E27 porcelain socket
 - power supply: 230 V~ / 50 Hz
 - white
 - size: 22,5 x 7,4 x 7 cm
 The luminaire can work with bulbs with the following energy class: A++/A+/A.



400.000.110/1

- 1 pc/nylon

400.001.112

Ceiling light with motion sensor



- metal luminaire, glass cover
 - 360° motion detecting
 - adjustable lighting time (10 sec - 6 mins.)
 - adjustable brightness
 - E27 porcelain sockets
 - power supply: 230 V~ / 50 Hz / max. 2 x 25 W
 - size: Ø300 x 105 mm
 The luminaire can work with bulbs with the following energy class: A++/A+/A/B/C/D/E.



400.223.115

Ceiling light with motion sensor

- black



AQUA FULLMOON OPAL
 - shockproof plastic luminaire and cover
 - with microwave motion sensor
 - adjustable brightness, ambient light level, lighting time
 - outdoor design (IP54)
 - E27 porcelain socket / max. 60 W
 - power supply: 230 V~ / 50 Hz
 - size: Ø24,3 x 10,6 cm
 The luminaire can work with bulbs with the following energy class: A++/A+/A/B/C/D/E.

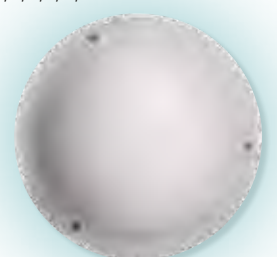

400.213.115

- white

400.123.114 Ceiling light

- black



AQUA HALF MOON OPAL
 - shockproof plastic luminaire and cover
 - outdoor design (IP54)
 - E27 porcelain socket / max. 60 W
 - power supply: 230 V~ / 50 Hz
 - size: 25 x 20,2 x 10,5 cm
 The luminaire can work with bulbs with the following energy class: A++/A+/A/B/C/D/E.



400.113.114

- white

400.123.115 Ceiling light

- black



AQUA FULLMOON OPAL
 - shockproof plastic luminaire and cover
 - outdoor design (IP54)
 - E27 porcelain socket / max. 60 W
 - power supply: 230 V~ / 50 Hz
 - size: Ø24,3 x 10,6 cm
 The luminaire can work with bulbs with the following energy class: A++/A+/A/B/C/D/E.

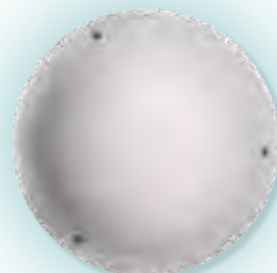

400.113.115

- white

400.010.116 Standing garden lamp

- black



BEGONYA GARDEN LAMP
 - shockproof plastic luminaire and cover
 - outdoor design (IP54)
 - E27 plastic socket / max. 40 W
 - power supply: 230 V~ / 50 Hz
 - size: 22,3 x 42,8 cm
 The luminaire can work with bulbs with the following energy class: A++/A+/A/B/C/D/E.



400.020.116

- white

400.010.117 Garden console lamp

- black



BEGONYA-2 GARDEN LAMP
 - shockproof plastic luminaire and cover
 - outdoor design (IP54)
 - E27 plastic socket / max. 40 W
 - power supply: 230 V~ / 50 Hz
 - size: 19,2 x 22,5 x 36,2 cm
 The luminaire can work with bulbs with the following energy class: A++/A+/A/B/C/D/E.



400.020.117

- white



outdoor ceiling light, standing lamp, console lamp

E14/E27

Socket converter

- allows to use light sources with different sockets in E27 sockets
- max. 2 A

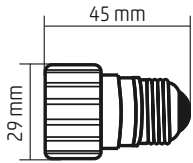

E27/E14

Socket converter

- allows to use light sources with different sockets in E14 sockets
- max. 2 A

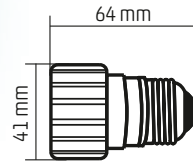

GU10/E14

Socket converter

- allows to use GU10 light sources with in E14 sockets
- max. 2 A

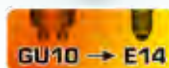
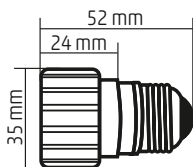

GU10/E27

Socket converter

- allows to use GU10 light sources with in E27 sockets
- max. 2 A

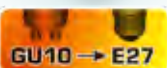
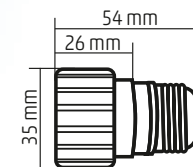

E14/GU10

Socket converter

- allows to use E14 light sources in GU10 sockets
- max. 0,3 A

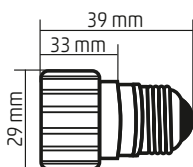

E27/GU10

Socket converter

- allows to use E27 light sources in GU10 sockets
- max. 0,3 A

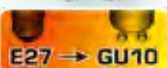
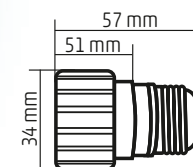

LH 0.5S/14M

LED bulb, cylindrical



- output: 0,5 W
- energy consumption: 0,5 kWh/1000 h
- socket: E14
- power consumption: 6 mA
- colour temperature: 2900 K, warm white
- lifetime: 26000 h
- flux: 30 lm
- 5 x SMD LED
- energy class: A



LH 1/14M

LED bulb, cylindrical



- output: 1 W
- energy consumption: 1 kWh/1000 h
- socket: E14
- power consumption: 13 mA
- colour temperature: 2900 K, warm white
- lifetime: 26000 h
- flux: 64 lm
- 16 x SMD LED
- energy class: A



energy saving bulbs



Savings of carbon dioxide emission compared to equivalent standard bulbs during the entire service life. (Calculated upon the recommendations of the European Union Commission.)

<p>KFS 5/14M</p> <p>Spiral</p> <p>-CO₂ -78 kg</p>	<p>KFS 5/27M</p> <p>Spiral</p> <p>-CO₂ -78 kg</p>	<p>KFS 9/14M KFS 9/14H</p> <p>Spiral</p> <p>-CO₂ -122 kg</p>	<p>KFS 9/27M KFS 9/27H</p> <p>Spiral</p> <p>-CO₂ -122 kg</p>	<p>KFS 13/14M KFS 13/14H</p> <p>Spiral</p> <p>-CO₂ -204 kg</p>	
<p>KFS 13/27M KFS 13/27H</p> <p>Spiral</p> <p>-CO₂ -204 kg</p>	<p>KFS 20/27M KFS 20/27H</p> <p>Spiral</p> <p>-CO₂ -314 kg</p>	<p>KFS 25/27M KFS 25/27H</p> <p>Spiral</p> <p>-CO₂ -392 kg</p>	<p>KFM 40/27H</p> <p>Spiral</p> <p>-CO₂ -627 kg</p>	<p>KFM 60/27H</p> <p>Spiral</p> <p>-CO₂ -941 kg</p>	
<p>KFU 7/14M</p> <p>2U</p> <p>-CO₂ -110 kg</p>	<p>KFU 7/27M</p> <p>2U</p> <p>-CO₂ -110 kg</p>	<p>KFU 11/27M</p> <p>2U</p> <p>-CO₂ -192 kg</p>	<p>KFU 15/27M</p> <p>2U</p> <p>-CO₂ -235 kg</p>	<p>KFG 7/14M</p> <p>Candle</p> <p>-CO₂ -110 kg</p>	<p>KFGL 9/14M</p> <p>Candle light</p> <p>-CO₂ -122 kg</p>

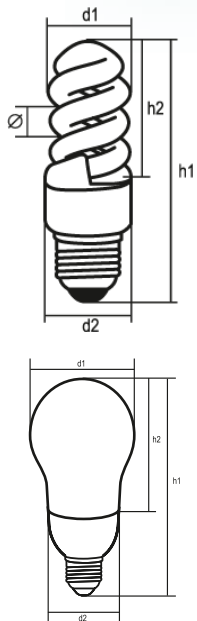

type	output	energy consumption	socket	power consumption	colour temperature	service life	flux	h1	h2	Ø	d1	d2
KFS 5/14M	5 W	5 kWh / 1000 h	E14	33 mA	2700 K	6000 h	229 lm	89	41	9/T3	33	38
KFS 5/27M	5 W	5 kWh / 1000 h	E27	33 mA	2700 K	6000 h	229 lm	89	41	9/T3	33	38
KFS 9/14M	9 W	9 kWh / 1000 h	E14	33 mA	2700 K	6000 h	462 lm	105	50	9/T3	33	38
KFS 9/14H	9 W	9 kWh / 1000 h	E14	33 mA	4200 K	6000 h	462 lm	105	50	9/T3	33	38
KFS 9/27M	9 W	9 kWh / 1000 h	E27	33 mA	2700 K	6000 h	462 lm	105	50	9/T3	33	38
KFS 9/27H	9 W	9 kWh / 1000 h	E27	33 mA	4200 K	6000 h	462 lm	105	50	9/T3	33	38
KFS 13/14M	13 W	13 kWh / 1000 h	E14	46 mA	2700 K	6000 h	826 lm	111	60	9/T3	33	38
KFS 13/14H	13 W	13 kWh / 1000 h	E14	46 mA	4200 K	6000 h	826 lm	111	60	9/T3	33	38
KFS 13/27M	13 W	13 kWh / 1000 h	E27	46 mA	2700 K	6000 h	826 lm	111	60	9/T3	33	38
KFS 13/27H	13 W	13 kWh / 1000 h	E27	46 mA	4200 K	6000 h	826 lm	111	60	9/T3	33	38
KFS 20/27M	20 W	20 kWh / 1000 h	E27	73 mA	2700 K	6000 h	1398 lm	135	80	9/T3	43	50
KFS 20/27H	20 W	20 kWh / 1000 h	E27	73 mA	4200 K	6000 h	1398 lm	135	80	9/T3	43	50
KFS 25/27M	25 W	25 kWh / 1000 h	E27	174 mA	2700 K	6000 h	1840 lm	160	95	12/T4	54	60
KFS 25/27H	25 W	25 kWh / 1000 h	E27	174 mA	4200 K	6000 h	1840 lm	160	95	12/T4	54	60
KFM 40/27H	40 W	40 kWh / 1000 h	E27	290 mA	4200 K	6000 h	3113 lm	190	105	14/T5	72	83
KFM 60/27H	60 W	60 kWh / 1000 h	E27	410 mA	4200 K	6000 h	4330 lm	245	162	16/T5	75	82
KFU 7/14M	7 W	7 kWh / 1000 h	E14	29 mA	2700 K	6000 h	368 lm	125	60	12/T4	27	39
KFU 7/27M	7 W	7 kWh / 1000 h	E27	29 mA	2700 K	6000 h	368 lm	125	60	12/T4	27	39
KFU 11/27M	11 W	11 kWh / 1000 h	E27	36 mA	2700 K	6000 h	741 lm	145	80	12/T4	27	39
KFU 15/27M	15 W	15 kWh / 1000 h	E27	44 mA	2700 K	6000 h	970 lm	165	100	12/T4	27	39
KFG 7/14M	7 W	7 kWh / 1000 h	E14	50 mA	2700 K	6000 h	368 lm	103	52	7/T2	36	37
KFGL 9/14M	9 W	9 kWh / 1000 h	E14	55 mA	2700 K	6000 h	440 lm	133	84	7/T2	40	37

Each light source has energy efficiency class: A

LED bulbs



picture	type	output	energy consumption	socket	colour temperature	service life	flux
1	ELITE-4 E14 3000K/HL 4380L	3,5 W	3,5 kWh/ 1000 h	E 14	3000 K	25000 h	250 lm
1	ELITE-4 E14 4200K/HL 4380L	3,5 W	3,5 kWh/ 1000 h	E 14	4200 K	25000 h	250 lm
2	ELITE-4 E27 3000K/HL 4380L	3,5 W	3,5 kWh/ 1000 h	E 27	3000 K	25000 h	250 lm
3	ELITE-6 E14 3000K / E14	6 W	6 kWh/ 1000 h	E 14	3000 E	25000 h	480 lm
3	ELITE-6 E14 4200K / E14	6 W	6 kWh/ 1000 h	E 14	4200 E	25000 h	480 lm
4	FONIX-6 3000K / GU5.3	6 W	6 kWh/ 1000 h	GU 5,3	3000 K	25000 h	390 lm
4	FONIX-6 4200K / GU5.3	6 W	6 kWh/ 1000 h	GU 5,3	3000 K	25000 h	390 lm
5	PLUS-4 3000K / GU10	4 W	4 kWh/ 1000 h	GU 10	3000 K	25000 h	250 lm
5	PLUS-4 4200K / GU10	4 W	4 kWh/ 1000 h	GU 10	4200 K	25000 h	250 lm
6	PLUS-6 3000K / GU10	6 W	6 kWh/ 1000 h	GU 10	3000 K	25000 h	390 lm
6	PLUS-6 4200K / GU10	6 W	6 kWh/ 1000 h	GU 10	4200 K	25000 h	390 lm
7	PREMIER-10 3000K/HL 4310L	10 W	10 kWh/ 1000 h	E 27	3000 K	25000 h	1000 lm
7	PREMIER-10 4200K/HL 4310L	10 W	10 kWh/ 1000 h	E 27	4200 K	25000 h	1000 lm
7	PREMIER-10 6400K/HL 4310L	10 W	10 kWh/ 1000 h	E 27	6400 K	25000 h	1000 lm
8	PREMIER-12 3000K/HL 4312L	12 W	12 kWh/ 1000 h	E 27	3000 K	25000 h	1050 lm
8	PREMIER-12 4200K/HL 4312L	12 W	12 kWh/ 1000 h	E 27	4200 K	25000 h	1050 lm
9	PREMIER-15 3000K	15 W	15 kWh/ 1000 h	E 27	3000 K	25000 h	1400 lm
9	PREMIER-15 4200K	15 W	15 kWh/ 1000 h	E 27	4200 K	25000 h	1400 lm
10	PREMIER-8 3000K/HL 4308L	8 W	8 kWh/ 1000 h	E 27	3000 K	25000 h	850 lm
10	PREMIER-8 4200K/HL 4308L	8 W	8 kWh/ 1000 h	E 27	4200 K	25000 h	850 lm
10	PREMIER-8 6400K/HL 4308L	8 W	8 kWh/ 1000 h	E 27	6400 K	25000 h	850 lm
11	ULTRA-4 3000K / HL 4360L	3,5 W	3,5 kWh/ 1000 h	E 14	3000 K	25000 h	250 lm
11	ULTRA-4 4200K / HL 4360L	3,5 W	3,5 kWh/ 1000 h	E 14	4200 K	25000 h	250 lm
12	ULTRA-6 3000K	6 W	6 kWh/ 1000 h	E 14	3000 K	25000 h	480 lm
12	ULTRA-6 4200K	6 W	6 kWh/ 1000 h	E 14	4200 K	25000 h	480 lm

Each light source has energy efficiency class: A

Halogen bulbs



The photo is an illustration!

type	denomination	output	energy consumption	socket	color temperature	service life	flux
AF 18/E14	Halogen Candle	18 W	18 kWh / 1000 h	E14	2700 K	2000 h	204 lm
AF 18/E27	Halogen Classic	18 W	18 kWh / 1000 h	E27	2700 K	2000 h	204 lm
AF 28/E14	Halogen Candle	28 W	28 kWh / 1000 h	E14	2700 K	2000 h	370 lm
AF 28/E27	Halogen Classic	28 W	28 kWh / 1000 h	E27	2700 K	2000 h	370 lm
AF 28/GU10	Halogen Spot	28 W	28 kWh / 1000 h	GU 10	2700 K	2000 h	350 lm
AF 42/E14	Halogen Candle	42 W	42 kWh / 1000 h	E14	2700 K	2000 h	624 lm
AF 42/E27	Halogen Classic	42 W	42 kWh / 1000 h	E27	2700 K	2000 h	624 lm
AF 42/GU10	Halogen Spot	42 W	42 kWh / 1000 h	GU 10	2700 K	2000 h	630 lm
AF 52/E27	Halogen Classic	52 W	52 kWh / 1000 h	E27	2700 K	2000 h	815 lm
AF 70/E27	Halogen Classic	70 W	70 kWh / 1000 h	E27	2700 K	2000 h	1179 lm
AF M18/E14	Halogen Classic Mini	18 W	18 kWh / 1000 h	E14	2700 K	2000 h	204 lm
AF M18/E27	Halogen Classic Mini	18 W	18 kWh / 1000 h	E27	2700 K	2000 h	204 lm
AF M28/E14	Halogen Classic Mini	28 W	28 kWh / 1000 h	E14	2700 K	2000 h	370 lm
AF M28/E27	Halogen Classic Mini	28 W	28 kWh / 1000 h	E27	2700 K	2000 h	370 lm
AF M42/E14	Halogen Classic Mini	42 W	42 kWh / 1000 h	E14	2700 K	2000 h	624 lm
AF M42/E27	Halogen Classic Mini	42 W	42 kWh / 1000 h	E27	2700 K	2000 h	624 lm
AF R50 18/E14	Halogen R50	18 W	18 kWh / 1000 h	E14	2700 K	2000 h	204 lm
AF R50 28/E14	Halogen R50	28 W	28 kWh / 1000 h	E14	2700 K	2000 h	370 lm
AF R50 42/E14	Halogen R50	42 W	42 kWh / 1000 h	E14	2700 K	2000 h	624 lm
AF R63 18/E27	Halogen R63	18 W	18 kWh / 1000 h	E27	2700 K	2000 h	204 lm
AF R63 28/E27	Halogen R63	28 W	28 kWh / 1000 h	E27	2700 K	2000 h	370 lm
AF R63 42/E27	Halogen R63	42 W	42 kWh / 1000 h	E27	2700 K	2000 h	624 lm

Each light source has energy efficiency class: C



Sensors and expandable monitoring systems to protect our health and property. The Honeywell carbon monoxide sensors, which are made in the European Union, have been proven countless times that we can rely on them. Among the competitors this brand is outstanding, has unique features and extremely long life span. The audio and video door phones and other monitoring systems provides comfort and safety so it gives our buyers the peace of mind.

Security systems

XC100D-HU

Carbon monoxide alarm

Honeywell

- meets EN 50291-1 standards
- electrochemical sensor
- alarm memory, event logging
- low gas concentration measurement mode: CO-sensor testing!
- life end notice
- self-test: every 60 minutes
- can be installed in bathrooms (IP44)
- built-in accumulator: 3 V, lithium
- operating temperature: -10 °C- +45 °C
- allowed humidity: 25-95%
- life time and warranty: 10 years
- LED indicators: power supply, fault, airing
- large alarm message
- informing LCD display
- size: 100 x 72 x 36 mm



XC100D-SK

Can be purchased only in Slovakia!

XC100-HU

Carbon monoxide alarm

Honeywell

- meets EN 50291-1 standards
- electrochemical sensor
- alarm memory, event logging
- low gas concentration measurement mode: CO-sensor testing!
- life end notice
- self-test: every 60 minutes
- can be installed in bathrooms (IP44)
- built-in accumulator: 3 V, lithium
- operating temperature: -10 °C- +45 °C
- allowed humidity: 25-95%
- life time and warranty: 10 years
- LED indicators: power supply, fault, airing
- large alarm message
- size: 100 x 72 x 36 mm



XC70-HU

Carbon monoxide alarm

Honeywell

- meets EN 50291-1 standards
- electrochemical sensor
- alarm memory, event logging
- low gas concentration measurement mode: CO-sensor testing!
- life end notice
- self-test: every 60 minutes
- can be installed in bathrooms (IP44)
- built-in accumulator: 3 V, lithium
- operating temperature: -10 °C- +45 °C
- allowed humidity: 25-95%
- life time and warranty: 7 years
- LED indicators: power supply, alarm, fault, airing
- size: 100 x 72 x 36 mm



carbon monoxide alarm, smoke detector, fire detector

XC100-SK

Can be purchased only in Slovakia!



XC70-SK

Can be purchased only in Slovakia!



XS100T-HU

Combined heat and smoke detector

Honeywell

- with optical and heat detector for faster reaction and less false alarm
- for escape routes, bedrooms and parlours
- for bedrooms and halls
- high reliability
- easy installation
- protected against tampering
- easy to use user interface
- alarm noise level: >85 dB
- checks function
- power supply: built-in long life lithium battery, 3 V, not replaceable
- size: Ø116 x 42 mm



XS100-HU

Smoke detector

Honeywell

- with optical smoke detector
- for bathrooms and halls
- high reliability
- easy installation
- protected against tampering
- easy to use user interface
- alarm noise level: >85 dB
- checks function
- power supply: built-in long life lithium battery, 3 V, not replaceable
- size: Ø116 x 42 mm

XH100-HU

Fire detector, heat speed sensor

Honeywell

- heat speed detector to the kitchen for less false alarm
- high reliability
- easy installation
- protected against tampering
- easy to use user interface
- alarm noise level: >85 dB
- checks function
- power supply: built-in long life lithium battery, 3 V, not replaceable
- size: Ø116 x 42 mm

HS 800 Wireless alarm control panel with dialer function



100 meters



- the content of the wireless system: central unit
- range in open area: 100 m
- the central unit alarms if the additional units signs (alarm or ding-dong), and initiate phone call
- 5 different phone numbers can be set up
- remote control functions in the event of alarm („interception”, „speakerphone”, „turning off”)
- unique security setup function (max. 6 characters)
- large LCD display
- adjustable delay time
- built-in siren (105 dB)
- silent alarm
- accessories: adapter, phone cable, installation equipments
- expandable with a maximum of 16 wireless sensors (HS 72, HS 74) and 8 remote controllers (HS 75)
- with expandable wired sensors: 1-1 pc of wired sirens (HS 63), motion sensor (HS 64), and wired opening sensor (HS 62)
- power supply: central unit: adapter (9 V DC / 500 mA) (included), in security mode 6F22 (9 V) battery (not included)
- size: 163 x 103 x 35 mm



HS 70 Wireless alarm set with dialer function



100 meters

2 in 1 alarm & chime



- the contents of the wireless system: central unit, remote controller, motion sensor, door/window opening sensor
- range in open space: 100 m
- the central unit alarms if the additional units signs (alarm or ding-dong), and the central unit initiates phone calls
- the device signs and initiates phone calls when there's a movement within the detection range
- motion detecting range: 12 m
- 5 different phone numbers can be set up
- unique security setup function (max. 6 characters)
- large LCD display
- adjustable delay time
- built-in siren (105 dB)
- silent alarm
- accessories: adapter, phone cable, installation equipments
- expandable with a maximum of 8 wireless sensors (HS 75, HS 72, HS 74)
- expandable with wired sensors: 1-1 pc of wired siren (HS 63) and motion detector (HS 64), wired opening sensor (HS 62)
- power supply: central unit: adapter (9 V DC/500 mA) (included), in security mode 6F22 (9 V) battery (not included), remote controller: 1 x LR23 (12 V) (included), opening sensor: 6F22 (9 V) battery (not included), motion sensor: 6F22 (9 V) battery (not included)
- size: central unit: 80 x 45 x 150 mm, remote controller: 67 x 44 x 15 mm, opening sensor: 58 x 26 x 87 mm, motion sensor: 64 x 68 x 110 mm



HS 60 Wired alarm set with dialer function



2 in 1 alarm & chime



- the device signs and initiates phone calls when there's a movement within the detection range
- detection range: 12 m
- 5 different phone numbers can be set up
- unique security setup function (max. 6 characters)
- large LCD display
- adjustable delay time
- silent alarm
- sound signal can be switched off
- alarm memory
- 2 kinds of sound signal: alarm or ding-dong
- accessories: adapter, phone cable, installation equipments
- expandable with 1-1 pc of wired siren (HS 63) and motion sensor (HS 64), wired opening sensors (HS 62), remote controllers (HS 61)
- power supply: adapter (9 V DC / 500 mA) (included), in security mode 6F22 (9 V) battery (not included), remote controller: 3 x LR44 (AG13) (1,5 V) (included)
- size: alarm: 80 x 45 x 150 mm, remote controller: 67 x 45 x 15 mm

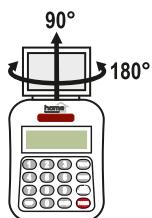

HS 50

Number coded infrared alarm with remote controller



- the device signs when senses movement in the detection range
- detection range: 12 m
- unique security setup function (max. 6 characters)
- adjustable alarm and delay time
- adjustable sensitivity
- sound signal can be switched off
- alarm memory
- accessories: adapter, installation equipments
- expandable with 1 pc of wired siren (HS 63), wired opening sensors (HS 62), remote controllers (HS 61)
- power supply: adapter (9 V DC / 500 mA) (included), in security mode 6F22 (9 V) battery (not included), remote controller: 3 x LR44 (AG13) (1,5 V) (included)
- size: alarm: 80 x 45 x 135 mm, remote controller: 67 x 45 x 15 mm

+2 pairs
of opening
sensors as a gift



HS 72

Opening sensor



- for HS 70, HS 800 devices
- beacon + 1 pair of opening sensor
- detection range in open space: 100 m
- with magnetic opening sensor (HS 62) can be connected in series unlimitedly
- power supply: 6F22 (9 V) battery (not included)
- size: 58 x 26 x 87 mm

HS 74

Opening sensor



- for HS 70, HS 800 devices
- detection range: 8 m
- detection angle: 120°
- accessory: wall mounted holder
- power supply: 6F22 (9 V) battery (not included)
- size: 64 x 68 x 110 mm

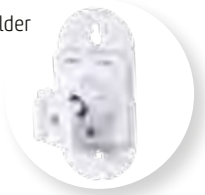

HS 75

Remote controller

- for HS 70, HS 800 devices
- power supply: 1 x LR23 (12 V) (included)
- size: 67 x 44 x 15 mm



HS 40

Number coded infrared alarm with siren



- the device signs when senses movement in the detection range
- detection range: 12 m
- unique security setup function (max. 6 characters)
- adjustable alarm and delay time
- sound signal can be switched off
- alarm memory
- can be set up on desktop or can be wall-mounted
- accessories: adapter, wire, installation equipment
- power supply: adapter (9 V DC / 500 mA) (included), in safety mode 6F22 (9 V) battery (not included)
- siren: siren: Ø91 x 114 x 118 mm, alarm: 78 x 44 x 140 mm

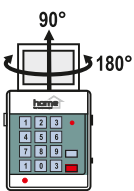

+1 pc
of siren
as a gift



HS 61

Remote controller

- for HS 50, HS 60 devices
- power supply: 3 x LR44 (AG13) (1,5 V) (included)
- size: 67 x 45 x 15 mm



HS 64

Motion sensor

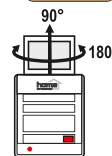

- for HS 60, HS 70, HS 800 devices
- detection range: 12 m
- accessory: 15 m wire
- size: 81 x 141 x 50 mm



HS 62

Opening sensor



- for HS 50, HS 60, HS 70, HS 800 devices
- 2 pairs of opening sensors for alarms
- accessories: 18 m wire, installation equipment
- size: 13 x 52,5 x 13,5 mm



AM 500

Wireless alarm system



- alarms for window-, and door opening, and for motion
- unlimitedly expandable with further sensors
- interfere protected, 16 digital channels
- detection range in open space: 30 m
- huge volume: 2 x 110 dB
- tamper protected control panel and outer siren
- 1 pc of motion sensor and 1 pc of opening sensor in the pack
- inner and outer siren 4 x AA (1,5 V) battery (not included)
- power supply of the sensors: 1-1 pc of 6LR61 (9 V) battery (not included)
- power supply of the control panel: adapter (included)
- battery operated in case of powercut 3 x AA (1,5 V) battery (not included)
- size: control panel: 153 x 98 x 39 mm
outer siren: 68 x 94 x 35 mm
motion sensor: 61 x 109 x 41 mm
opening sensor: 59 x 98 x 26 mm



AM 552

Wireless motion sensor



- to expand AM 500 wireless alarm system
- can not be used individually
- alerts when motion is detected, within approx. 7 m distance
- can be connected unlimitedly to an existing system
- interfere protected, 16 digital channels
- detection range in open space: 30 m
- adjustable wall mounted holder
- power supply: 6LR61 (9 V) battery (not included)
- size: 61 x 109 x 41 mm



AM 503

Wireless opening sensor



- to expand AM 500 wireless alarm system
- can not be used individually
- alerts when window or door opening is detected
- can be connected unlimitedly to an existing system
- interfere protected, 16 digital channels
- detection range in open space: 30 m
- power supply: 6LR61 (9 V) battery (not included)
- size: 59 x 98 x 26 mm



HS 63

Siren



- for HS 50, HS 60, HS 70, HS 800 devices
- high volume, single-tone siren (120 dB)
- accessories: 15 m wire, installation equipment
- size: Ø91 x 114 x 118 mm



SZ 3-6

Siren

- 6 sounds

- dome speaker
- voltage: 6 - 15 V⁻⁻⁻
- output: 20 W
- volume: 108 dB
- Ø87 x 104 mm
- height including the base: 112 mm



SZ 3-1

- 1 sound

SZ 1-1

Siren

- 1 sound
- piezo speaker
- voltage: 6 - 16 V⁻⁻⁻
- output: 20 W
- volume: 100 dB
- 45 x 40 x 60 mm
- height including the base: 57 mm



Z 2

Buzzer

- piezo speaker
- voltage: 1,5 - 12 V⁻⁻⁻
- volume: 85 dB/30 cm
- Ø22 x 10 mm



HSB 120

Wireless entry alarm



- the receiving unit emits sound and light signals when stepping into the range of the entry alarm
 - motion detection: horizontally within 40°, 5-6 m
 - 433,92 MHz, max. 120 m radio range in open space
 - precoded, easy to setup
 - it can control a maximum of 3 sensors, 1 pc is accessory (HSB 120/T)
 - motion sensor can be used outdoors (IP44)
 - accessories: screws and dowels
 - power supply: PIR: 3 x 1,5 V (AAA) batteries, not included
indoor unit: 3 x 1,5 V (C) batteries, not included
 - size: 95 x 130 x 43 mm / 63 x 105 x 46 mm
- The appliance is suitable for use in the European Union member states.



HSB 120/T

Outer PIR sensor for HSB 120



HS 11

Entry alarm with wall-mounted holder

- the entry alarm emits sound signals (ding-dong) when stepping into the range of the sensor
- detection range: 4-5 m
- adjustable in 120° due to the tiltable wall-mounted holder
- adjustable volume, it can be switched off as well
- optionally an adapter can be connected
- power supply: 4 x AA (1,5 V) (not included);
6V DC / 300 mA adapter (not included)
- size: 110 x 83 x 50 mm, holder: 83 x 40 x 35 mm



HS 10

Entry alarm

- the entry alarm emits sound signals (ding-dong) when stepping into the range of the sensor
- detection range: 3-4 m
- adjustable volume, it can be switched off as well
- can be fixed with the self adhesive tape on its back
- power supply: 2 x AAA (1,5 V) (not included)
- size: 52 x 71 x 25 mm



HS 22/2

Door and window opening alarm

- 2 pcs / pack



- continuously alerts when senses door or window opening (100 dB)
- can be fixed with the self adhesive tape on its back
- can be switched off
- power supply: 3 x AG13 (1,5 V) button batteries (included)
- size: 30 x 62 x 25 mm / 11 x 60 x 20 mm



HS 22/4

- 4 pcs / pack



HS 20

Door and window opening alarm

- continuously alerts when senses door or window opening (100 dB)
- can be fixed with the self adhesive tape on its back
- can be switched off
- power supply: 3 x AG13 button batteries (1,5 V) (included)
- size: 30 x 62 x 22 mm / 12 x 53 x 13 mm



HS 21

Door and window opening sensor/ alarm

- emits sound signal when senses door or window opening
- two functions: Chime: ding-dong sound signal; ALARM: alert (100 dB)
- can be fixed with the self adhesive tape on its back
- can be switched off
- power supply: 3 x AG13 button batteries (1,5 V) (included)
- size: 59 x 98 x 26 mm



HS 01

Door and window opening alarm with crash and shock sensor

- alerts when senses windor/door crash or shock (for 15-20 sec)
- loud alert (100 dB)
- adjustable sensitivity, it can be switched off optionally
- can be fixed with the self adhesive tape on its back
- power supply: 2 x AAA (1,5 V) (not included)
- size: 52 x 71 x 23 mm



HSK 110 Outdoor dummy camera

- real camera design
- for indoor and outdoor use
- tiltable, rotatable
- constantly blinking red LED
- power supply: 2 x AA (1,5 V) (not included)
- size: 230 x 170 x 85 mm



HSK 300 Wall or ceiling mounted dummy camera



- realistic dome camera design
- durable ABS base material
- 25 red LEDs, glowing in the dark
- can be mounted to the wall or ceiling
- screws and dowels included
- up to 1 year operation time
- power supply: 2 x AA (1,5 V) batteries (not included)
- size: Ø130 x 260 mm



HSK 200 Dummy camera with motion sensor

- real camera design
- blinking LED light and scanning motion when detects movements
- multiple mounting alternatives
- can be tilted using the base
- no cabling required
- power supply: 3 x AA (1,5 V) batteries (not included)
- size: camera: 135 x 55 x 55 mm
base: 80 x 55 x 100 mm



HSK 120 Dummy camera with motion sensor

- real dome camera design
- built-in motion sensor
- easy to turn on/off
- blinking LED when senses
- easily mountable
- power supply 2 x AA (1,5 V) battery (not included)
- size: Ø120 x 75 mm



RC-OPEN4 Universal gate opener, with fix code

- universal remote controller, with fix code
- combined metal and plastic housing
- to open/close garage doors, electric gates etc...
- can be used for 433 MHz systems
- 4 programmable buttons
- does not forgets the codes when battery is changed
- power supply: LR 27A (12 V) battery (included)
- size: 55 x 30 x 13 mm



RC-OPEN4/P Universal gate opener, with fix code

- universal remote controller, with fix code
- plastic housing
- to open/close garage doors, electric gates etc...
- can be used for 433 MHz systems
- 4 programmable buttons
- does not forgets the codes when battery is changed
- power supply: LR 23A (12 V) battery (included)
- size: 60 x 39 x 16 mm



dummy camera, remote controller

DPV 25 Intercom video doorphone



- 7" (17,5 cm) color LCD monitor, elegant, ultra thin
- massive, vandal-proof metal outdoor unit with hidden camera
- night camera mode with hidden infrared LEDs
- 3 modes to install outdoor unit: outside on the wall / recessed / in the corner
- versatile expanding options: 1x camera + 1x monitor / 1x camera + 2x monitor / 2x camera + 1x monitor / 2x camera + 2x monitor / 1x camera + 3x monitor
- intercom (home phone) function in case of minimum 2 monitors
- excellent screen quality: 800x480 TFT LCD
- time and day display
- takes photo of the visitor and time stamps it
- max. 20 photos can be stored and can be reviewed
- safety function: the lock opening only works when the monitor is turned on
- street view monitor even with 2 outdoor units
- sound and brightness regulating possibilities
- selectable ringing volume
- selectable ringtone
- 4-wired (between indoor and outdoor units)
- gate opener without electronic and additional power supply
- accessories for the outdoor unit: metal rain cover, metal recessable installation frame, 45 degree metal installation frame for corners, screws, fitted connection cable (cca. 3 m)
- accessories for the indoor unit: wall metal mount, mains adapter, 2 pcs of connectors for expanding the system
- power supply of outdoor / indoor unit: from the monitor / mains adapter 13,5 V / 1,5 A
- size of the outdoor / indoor unit: 40 x 121 x 22 mm / 220 x 146 x 25 mm



EXPANSION OPTIONS:

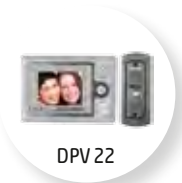
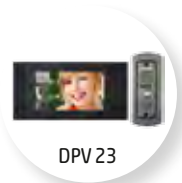

DPV 25B Video doorphone indoor unit



- suitable to expand the following doorphone sets: DPV 25, DPV 24, DPV 23, DPV 22
- 7" (17,5 cm) color LCD monitor, elegant, ultra thin
- intercom (home phone) function in case of minimum 2 intercom monitors
- excellent screen quality: 800x480 TFT LCD
- time and date display
- takes photo of the visitor and time stamps it
- max. 20 photos can be stored and can be reviewed
- safety function: the lock opening only works when the monitor is turned on
- street view monitor even with 2 outdoor units
- sound and brightness regulating possibilities
- selectable ringing volume
- selectable ringtone
- 4-wired (between indoor and outdoor units)
- gate opener without electronic and additional power supply
- accessories: metal wall mounting frame, mains adapter, 2 pcs of connectors for expanding the system
- power supply: mains adapter 13,5 V / 1,5 A, included
- size: 220 x 146 x 25 mm



DPV 25K Video doorphone outdoor unit



- suitable to expand the following doorphone sets: DPV 25, DPV 24, DPV 23, DPV 22
- massive, vandal-proof metal outdoor unit with hidden camera
- night camera mode with hidden infrared LEDs
- 3 modes to install outdoor unit: outside on the wall / recessed / in the corner
- 4-wired (between indoor and outdoor units)
- gate opening electronic system with short outer connecting wire
- accessories: metal rain cover, metal recessable installation frame, 45 degree metal installation frame for corners, screws, fitted connection cable (cca. 3 m)
- power supply: from the indoor unit
- size: 40 x 121 x 22 mm



- hidden camera
- hidden infrared light
- push-button



DPV 24 Wired color video doorphone set

- 4,3" (10,7 cm) color LCD monitor, elegant, ultra thin
- massive, vandal-proof metal outdoor unit with hidden camera
- night camera mode with hidden infrared LEDs
- 3 modes to install outdoor unit: outside on the wall / recessed / in the corner
- versatile expanding options: 1x camera + 1x monitor / 1x camera + 2x monitor / 2x camera + 1x monitor / 2x camera + 2x monitor / 1x camera + 3x monitor
- intercom (home phone) function in case of minimum 2 monitors
- excellent screen quality: 480x272 TFT LCD
- touch control buttons, time and date display
- takes photo of the visitor and time stamps it
- max. 20 photos can be stored and can be reviewed
- safety function: the lock opening only works when the monitor is turned on
- street view monitor even with 2 outdoor units
- sound and brightness regulating possibilities
- selectable ringing volume
- selectable ringtone
- 4-wired (between indoor and outdoor units)
- gate opener without electronic and additional power supply
- video output for outside display or monitor unit (eg. for TV-s)
- accessories for the outdoor unit: accessories: metal rain cover, metal recessable installation frame, 45 degree metal installation frame for corners, screws, fitted connection cable (cca. 3 m)
- accessories for indoor unit: wall metal installation frame, mains adapter, 2 pcs of connectors for expanding the system, short video-connector cable (RCA socket)
- size of outdoor / indoor unit: 40 x 121 x 22 mm / 190 x 80 x 18 mm
- power supply of outdoor / indoor unit: from the monitor / mains adapter 13,5 V $\overline{\text{---}}$ / 1,5 A



DP 012 2-flat wired doorphone set

METAL

- two indoor units and one outdoor unit
- doorphone system of 2 wires
- excellent quality sound transmission between the two units
- metal, recessable outdoor unit with 2 nameplates
- gate opening electric system without additional power supply
- exchangeable nameplate with red LED background light
- easy to install: the cable can be fixed with screws
- indoor units can be laid or mounted on the wall
- power supply: 230 V~ / 50 Hz
- size: 87 x 227 x 45 mm / 200 x 116 x 55 mm



DP 02 Wired doorphone set

METAL

- doorphone system of 2 wires
- excellent quality sound transmission between the two units
- metal, recessable outdoor unit
- gate opening electric system without additional power supply
- metal, recessable outdoor unit with nameplate
- easy to install: the cable can be fixed with screws
- indoor unit can be laid or mounted on the wall
- power supply: 230 V~ / 50 Hz
- size: 87 x 227 x 45 mm / 200 x 116 x 55 mm



DP 011 Wired doorphone set with two indoor units

METAL

INTERCOM

- 2in1: doorphone and intercom (home phone)
- two indoor units and one outdoor unit
- outdoor unit + room-room / ground floor-floor / house-garage / house-workshop...
- 2 wired (between indoor and outdoor units)
- metal, recessable outdoor unit
- exchangeable nameplate with red LED background light
- gate opening electric system without additional power supply
- effective range max. 500 m in case of 1 mm² (not included)
- indoor units can be placed on the furniture or mounted on the wall
- 1 m mains connecting cable, 230 V~ / 50 Hz
- installation size of outdoor unit: 117 x 200 x 17 mm / 95 x 165 x 40 mm



DP 01 Wired doorphone set

- doorphone system of 2 wires
- excellent quality sound transmission between the two units
- gate opening electric system without additional power supply
- easy to install: the cable can be fixed with screws
- indoor units can be laid or mounted on the wall
- power supply: 230 V~ / 50 Hz
- size: 87 x 227 x 45 mm / 73 x 100 x 36 mm



DC915EG

Wireless doorbell

- 200 meters
- bell push IP55
- 8 melodies

Honeywell

- range: max. 200 m
- volume: max 90 dB
- 8 melodies
- muteness timer: 3, 6, 9, 12 hours
- stroboscopic LED frame light
- LED flashlight turns on when rings
- adjustable volume
- IP55 protected push-button
- frequency: 868 MHz
- power supply of the bell: 4 x C (LR14) 1,5 V batteries (not included)
- power supply of the push-button: 1 x CR2032 3 V battery (included)
- size: indoor unit: 125 x 125 x 40 mm
push-button: 70 x 30 x 15 mm



DC313EP2

Wireless doorbell

- 150 meters
- bell push IP55
- 6 melodies

Honeywell

- range: max. 150 m
- volume: max 84 dB
- 6 melodies
- LED flashlight turns on when rings
- adjustable volume
- IP55 protected push-button
- frequency: 868 MHz
- power supply of the bell: 230 V~/ 50 Hz
- power supply of the push-button: 1 x CR2032 3 V battery (included)
- size: indoor unit: 110 x 70 x 40 mm
push-button: 70 x 30 x 15 mm



DC311EP2

Wireless doorbell

- 150 meters
- bell push IP55
- 4 melodies

Honeywell

- range: max. 150 m
- volume: max 80 dB
- 4 melodies
- IP55 protected push-button
- frequency: 868 MHz
- power supply of the bell: 230 V~/ 50 Hz
- power supply of the push-button: 1 x CR2032 3 V battery (included)
- size: indoor unit: 110 x 70 x 40 mm
push-button: 70 x 30 x 15 mm



DC313E

Wireless doorbell

- 150 meters
- bell push IP55
- 6 melodies

Honeywell

- range: max. 150 m
- volume: max 84 dB
- 6 melodies
- LED flashlight turns on when rings
- adjustable volume
- IP55 protected push-button
- frequency: 868 MHz
- power supply of the bell: 4 x AA (LR6) 1,5 V batteries (not included)
- power supply of the push-button: 1 x CR2032 3 V battery (included)
- size: indoor unit: 110 x 70 x 40 mm
push-button: 70 x 30 x 15 mm



DC311E

Wireless doorbell

- 150 meters
- bell push IP55
- 4 melodies

Honeywell

- range: max. 150 m
- volume: max 80 dB
- 4 melodies
- IP55 protected push-button
- frequency: 868 MHz
- power supply of the bell: 4 x AA (LR6) 1,5 V batteries (not included)
- power supply of the push-button: 1 x CR2032 3 V battery (included)
- size: indoor unit: 110 x 70 x 40 mm
push-button: 70 x 30 x 15 mm



DB 201AC

Wireless doorbell



- range in open space: cca. 200 m
- stylish, polyphonic sound
- 36 selectable melodies
- volume can be adjusted to 5 stages
- flashing light sign simultaneously with sound sign
- blue LED battery status display
- individually pre-coded
- operating frequency: 433,9 MHz
- power supply:
push-button: LR23A (12 V) battery, included
- indoor unit: 230 V~ / 50 Hz / 0,9 W
- size: indoor unit: 80 x 76 x 23 mm
push-button: 42 x 78 x 19 mm



DB 202AC

Wireless doorbell



- range in open space: cca. 200 m
- stylish, polyphonic sound
- 36 selectable melodies
- volume can be adjusted to 5 stages
- flashing light sign simultaneously with sound sign
- blue LED battery status display
- individually pre-coded
- operating frequency: 433,9 MHz
- power supply:
push-button: LR23A (12 V) battery, included
- indoor unit: 230 V~ / 50 Hz / 0,9 W
- size: indoor unit: 80 x 76 x 23 mm
push-button: 42 x 78 x 19 mm



DB 103AC

Battery-free, wireless doorbell



- range in open space: cca. 100 m
- 25 varied style melodies
- poliphonic, pleasant sound
- 3 stages of volumes
- blue LED indicators
- flashing light signal when alerts
- continuous night light function
- operating frequency: 433,9 MHz
- custom coding with learning function
- strongly interference protected from other doorbells
- power supply:
push-button: kinetic energy
- indoor unit: 230 V~ / 50Hz / 0,9W
- size: indoor unit: 90 x 140 x 24 mm
push-button: 45 x 103 x 25 mm



DB 102AC

Wireless doorbell



- range in open space: cca. 100 m
- 36 variety of melodies
- poliphonic, pleasant sound
- adjustable volume, 4 stages
- blue LED indicators
- IP44 dust and water resistant push-button
- individually pre-coded
- operating frequency: 433,9 MHz
- power supply:
push-button: LR23A (12 V), included
- indoor unit: 230 V~ / 50 Hz / 1 W
- size: indoor unit: 90 x 60 x 30 mm
push-button: 85 x 60 x 25 mm



DB 442

Wireless doorbell



- range in open space: cca. 100 m
- can be used with up to 4 push-buttons
- 256 different digital codes
- individually pre-coded
- settings will be retained in case of power failure
- operating frequency: 433,9 MHz
- volume control
- built-in mains socket for other devices: max. 13 A
- operation indicator LED on the indoor unit
- power supply:
push-button: 1 x CR2032 [3 V] battery (included)
- indoor unit: 230 V~ / 50 Hz
- size: indoor unit: 125 x 70 x 40 mm
push-button: 33 x 85 x 25 mm



WDB 113

Wireless doorbell



- range in open space: cca. 80 m
- sound and light signal simultaneously
- 32 selectable melodies
- individually pre-coded
- operating frequency: 433,9 MHz
- power supply:
push-button: 1 x LR23A (12 V)
- indoor unit: 230 V~ / 50 Hz
- size: indoor unit: 100 x 55 x 30 mm
push-button: 80 x 45 x 20 mm



DB 151DC

Wireless doorbell



- range in open space: cca. 150 m
- individually pre-coded
- operating frequency: 433,9 MHz
- 25 varied style melodies
- poliphonic, pleasant sound
- adjustable volume
- blue LED indicators
- power supply: push-button: LR23A (12 V) battery (included) indoor unit: 3 x AA (1,5V) batteries (not included)
- size: indoor unit: 80 x 115 x 33 mm push-button: 44 x 75 x 25 mm



DB 228

Wireless doorbell with light signal



- range in open space: cca. 150 m
- 3 operating modes: sound signal, light signal, sound + light signal
- sound signal is adjustable and can be turned off
- can be used with up to 4 push-buttons
- 256 different digital codes
- operating frequency: 433,9 MHz
- battery status display
- power supply: push-button: CR2032 (3V) battery (not included) indoor unit: 2 x C (2 x 1,5 V) batteries (not included)
- size: indoor unit: 92 x 144 x 43 mm push-button: 33 x 85 x 25 mm



DB 108

Wireless doorbell



- range in openspace: cca. 100 m
- can be used with up to 4 push-buttons
- 256 different digital codes
- individually pre-coded
- operating frequency: 433,9 MHz
- battery status display
- power supply: push-button: CR2032 (3 V) battery (included) indoor unit: 2 x AA (2 x 1,5 V) batteries (not included)
- size: indoor unit: 61 x 94 x 35 mm push-button: 33 x 85 x 25 mm



DB 128

Wireless doorbell



- 1 pc of push-button + 2 pcs of indoor units
- range in open space 100 m
- can be used with up to 4 push-buttons
- 256 different digital codes
- individually pre-coded
- operating frequency: 433,9 MHz
- battery status display
- power supply: push-button: CR2032 (3 V) battery (included) indoor unit: 2 x AA (2 x 1,5 V) batteries (not included)
- size: indoor unit: 61 x 94 x 35 mm push-button: 33 x 85 x 25 mm



DB 101DC

Wireless doorbell



- range in open space: cca. 100 m
- 36 variety of melodies
- poliphonic, pleasant sound
- adjustable volumes, 4 stages
- blue LED indicator
- individually pre-coded
- operating frequency: 433,9 MHz
- power supply: push-button: LR23A (12 V), included indoor unit: 3 x AAA (LR03), 1,5 V batteries (not included)
- size: indoor unit: 100 x 60 x 25 mm push-button: 80 x 45x 20 mm



DBP 01

Push-button for wireless doorbell



- range in open space: cca. 200 m
- 256 different digital codes
- operating frequency: 433,9 MHz
- for DB 108, DB 118, DBF 118, DB 128, DB 228, DB 238, DB 248, DB 268, DB 298 doorbells
- power supply: 1 x CR2032 [3 V] battery (included)
- size: 33 x 85 x 25 mm



WDB 121

Wireless doorbell

80
meters

IP40

32
melodies

- range in open space: cca. 80 m
- sound and light signal
- 32 variety of melodies
- individually pre-coded
- operating frequency: 433,9 MHz
- portable, can be used as paging system
- power supply:
push-button: 1 x LR23A (12 V)
indoor unit: 2 x AAA (1,5 V) batteries (not included)
- size: indoor unit: 100 x 75 x 30 mm
push-button: 80 x 45 x 20 mm



WDB 112

Wireless doorbell

80
meters

32
melodies

- range in open space: 80 m
- 32 selectable melodies, volume: ~85 dB
- individually pre-coded
- sound and light signal simultaneously
- portable, can be used as paging system
- power supply:
push-button: 1 x LR 23A (12 V) battery (included)
indoor unit: 2 x AA (1,5 V) batteries (not included)
- size: push-button: 80 x 45 x 20 mm
indoor unit: 100 x 75 x 30 mm



DB 0520DC

Wireless doorbell

50
meters

LED
LIGHT

VOLUME
CONTROL

36
melodies

- range in open space: cca. 50 m
- flashing light signal when ringing
- continuous flashlight function
- 36 variety of melodies
- volume can be adjusted to 4 stages
- blue LED indicators
- operating frequency: 433,9 MHz
- power supply:
push-button: LR23A (12 V) battery, included
doorbell: 2 x AAA (1,5 V) batteries, not included
- size: indoor unit: 95 x 63 x 30 mm
push-button: 75 x 37 x 22 mm



DB 0525DC

Wireless doorbell

50
meters

LED
LIGHT

VOLUME
CONTROL

36
melodies

- range in open space: cca. 50 m
- flashing light signal when ringing
- continuous flashlight function
- 36 variety of melodies
- volume can be adjusted to 4 stages
- blue LED indicators
- operating frequency: 433,9 MHz
- power supply of push-button:
LR23A (12 V) battery, included
- power supply of doorbell: 2 x AA (1,5 V) batteries, not included
- size: indoor unit: 11 x 63 x 30 mm
push-button: 75 x 37 x 22 mm



D 6

Wired bell

8
melodies

- can be used with the old push-button
- 8 different melodies
- power supply: 2 x AA (1,5 V) batteries (not included)
- size: 98 x 155 x 38 mm



**TLKR T80
EXTREME**

Transceiver pair, 10 km



- 8 PMR channels, 121 channels
- max. 10 km range
- 10 selectable ringer tune
- LCD display with background light
- caller ID
- VOX control
- "Roger" sound
- accumulator status display
- channel supervision
- keylock
- 16 hours of operation
- turns off automatically
- group call
- IPX2: protected against of dripping water
- power supply: 2 pcs of rechargeable NiMH accumulator (4,8V, 600 mA), or 4 pcs of AAA (LR03) batteries (not included)
- kit contents: 2 pcs of TLKR T80 EXTREME device, 2 pcs of belt clips, mains adapter, 2-device charging stand, 2 pcs of rechargeable NiMH accumulators (4,8V, 600 mA)



TLKR T50

Transceiver pair, 6 km



- 8 PMR channels, 121 channels
- max. 6 km range
- "Roger" sound
- accumulator status display
- channel supervision
- keylock
- 16 hours of operation
- power supply: 2 pcs of rechargeable NiMH accumulators (4,8V, 600 mA), or 4 pcs of AAA (LR03) batteries (not included)
- kit contents: 2 pcs of TLKR T50 devices, 2 pcs of belt clips, AC adapter, 2 pcs of rechargeable NiMH accumulators (4,8V, 600 mA)

TLKR T41

Transceiver pair, 4 km



- 8 PMR channels
- max. 4 km range
- 1 ringer tune
- "Roger" sound
- accumulator status display
- keylock
- 16 hours of operation
- power supply: 3 AAA (LR03)
- kit contents: 2 transceivers, 2 belt clips



in mixed colors



We can make our leisure activities more easier and more enjoyable with our range of product for home comfort. With the help of the weather station we can plan the weekend outdoor activities. For problem free TV watching a practical remote controller is necessary, and for good quality reception an excellent amplified indoor antenna is needed. For the use of electronic devices, a reliable mains adapter or accumulator charger is essential.

Home comfort

HCW 24

Weather station with outdoor transmitter

- very well visible, large display
- wall-mounted / desktop design
- expected weather icons
- 433 MHz outdoor temperature and humidity transmitter, max. 50 m range
- can handle max. 3 pcs of outdoor transmitters (1 pc included; HCKK 07)
- display of outdoor and indoor humidity and temperature
- display of maximum and minimum values
- DCF77 radio controlled clock (exact time)
- selectable time zone (-23 - +23 h)
- 12/24 hour time format
- alarm with snooze function
- easy setup
- power supply 6 x 1,5 V (AA) batteries (not included)
- size: 22,5 x 22,5 x 2,5 cm/6,5 x 10 cm

HCKK 07

Outdoor transmitter for HCW 24 weather station

- 433 MHz outer temperature and humidity transmitter, max. 50 m range
- can be wall-mounted or placed on desktop
- selectable 3 channels
- LCD display
- power supply 2 x 1,5 V (AA) batteries (not included)



HCW 23 Weather station with outdoor transmitter

- touch screen
 - orange background light
 - electronic barometer forecast expected weather icons
 - DCF77 radio controlled clock (exact time, date, day of the week)
 - 12/24 hour time format, +/- 12 h time zone
 - 2 separate alarms with snooze function
 - 868 MHz outdoor temperature and humidity transmitter, 60 m range in open space
 - the weather station can handle 3 outer transmitters (1 pc included, HCKK 06)
 - display of indoor and outdoor humidity and temperature
 - display of minimum and maximum temperatures
 - the weather station displays the battery status of itself and the transmitter
 - power supply 2 x 1,5 V (AAA) + 2 x 1,5 V (AA) batteries (not included)
 - size: 14,5 x 10 x 1,5 cm / 5,5 x 10,5 x 2,5 cm
- The device is suitable for use in the European Union member stages.

**HCKK 06** Outdoor transmitter for HCW 23 weather station**HCW 22** Weather station with outdoor transmitter

- expected weather symbols displayed
 - blue background light
 - actual lunar phase indicator
 - DCF 77 radio controlled clock, adjustable time zone
 - 12/24 hour time format
 - display of the date and day of the week
 - 433,92MHz outdoor temperature transmitter, 60 m rang in open space
 - the weather station can handle 3 outer transmitters (1 pc included, HCKK 05)
 - display of indoor and outdoor humidity and temperature
 - display of indoor humidity
 - display of indoor and outdoor temperature
 - temperature alarm values can be set up on each channel individually
 - alarm with snooze function
 - easy setup
 - power supply 3 x 1,5 V (AA) es 2 x 1,5 V (AAA) batteries (not included)
 - size: 21 x 13 x 2 cm / 6 x 9,5 x 2,5 cm
- The device is suitable for use in the European Union member stages.

**HCKK 05** Outdoor transmitter for HCW 22 weather station**HCW 20** Weather station with outdoor transmitter

- electronic barometer forecast expected weather icons
 - orange background light
 - 868 MHz outdoor temperature and humidity transmitter, max. 75 m range
 - can handle max. 3 pcs of outer transmitters (1 pc included: HCKK 03)
 - display of outdoor and indoor humidity and temperature
 - display of maximum and minimum values
 - DCF77 radio controlled clock (exact time, date, day of the week)
 - 12/24 hour time format
 - 2 separate alarms with snooze function
 - the weather station displays the battery status of itself and the transmitter
 - can be wall-mountable or placed on desktop
 - power supply 5 x 1,5 V (AA) batteries (not included)
 - size: 10 x 17 x 3 cm / 6,5 x 10 x 2,5 cm
- The device is suitable for use in the European Union member stages.

**HCKK 03** Outdoor transmitter for HCW 20 weather station

HCW 21

Weather station with outdoor transmitter

- 433,92 MHz outdoor temperature and humidity transmitter, max. 60 m range
 - can handle max. 3 pcs of outer transmitters (1 pc included: HCKK 04)
 - display of outdoor and indoor humidity and temperature
 - display of maximum and minimum values
 - DCF77 radio controlled clock (exact time, date, day of the week)
 - 12/24 hour time format, adjustable time zone
 - alarm with snooze function
 - the weather station displays the battery status of itself and the transmitter
 - can be wall-mountable or placed on desktop
 - temperature alarm values can be set up on each channel individually
 - power supply: 2 x 1,5 V (AA) es 2 x 1,5 V (AAA) batteries (not included)
 - size: 13 x 20 x 3 cm / 6 x 9,5 x 2,5 cm
- The device is suitable for use in the European Union member stages.



HC 11

Wireless outdoor-indoor thermometer with alarm clock

- 433,92 MHz outdoor temperature transmitter, max. 60 m range
 - can handle 1 pc of transmitter (included: HCKK 05)
 - display of maximum and minimum values
 - temperature measurement range: indoor: -9 - +50 °C, outdoor: -20 - +60 °C
 - 12/24 hour time format
 - can be wall-mountable or placed on desktop
 - power supply 4 x 1,5 V (AAA) batteries (not included)
 - size: 7,5 x 12,5 x 2 cm / 6 x 9,5 x 2,5 cm
- The device is suitable for use in the European Union member stages.



HCKK 04

Outdoor transmitter for HCW 21 weather station

HC 12

Wireless outdoor-indoor thermometer with clock

- display of indoor temperature (-9 - +50 °C)
- display of outdoor temperature (-50 - +70 °C)
- length of wired thermometer probe: 1,4 m
- display of maximum and minimum values
- 12/24 hour time format, date
- can be wall-mountable or placed on desktop
- power supply 2 x 1,5 V (AAA) batteries (not included)
- size: 7 x 12 x 2 cm



HC 13

Temperature and humidity meter with alarm clock

- display of indoor temperature (-9 - +50 °C)
- display of outdoor temperature (RH 20% - 90%)
- display of maximum and minimum values
- 12/24 hour time format, date, day of the week
- alarm with snooze function (8 minutes)
- can be wall-mountable or placed on desktop
- power supply 2 x 1,5 V (AAA) batteries (not included)
- size: 7 x 12 x 2 cm





BTCL 400 Portable multimedia player



- 6in1: BT/MP3/FM/microphone/AUX/alarm clock
- extra clearly visible matrix display
- powerful, dashed alarm sound
- BT connection up to 10 meters
- listening to music from mobile phones, computers
- music player application control
- phone conversations without touching the phone
- answer calls, refuse calls, dialing numbers
- MP3/WAV/APE/WMA playback from microSD card
- FM radio with automatic channel search
- frequency- and program area display
- wired audio line in (AUX IN)
- built-in sensitive microphone
- digital HiFi amplifier
- announcement when changing mode
- portable, with built-in Li-Po accumulator
- accessory: miniUSB power cable / 3,5 mm audio connection cable
- size: 116 x 87 x 37 mm



LTCR 01 Digital alarm clock with radio

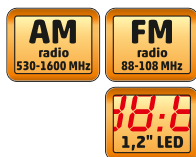

- 1,2" Jumbo display with adjustable brightness
- 24 hour time format
- alarm with radio or beep, with snooze function (8 minutes)
- time memory 9 V (6LR61) with battery (not included)
- power supply: 230 V~ / 50 Hz / 3 W
- size: 170 x 60 x 120 mm



LTC 01 Digital alarm clock



- 0,6" LED display
- 24 hour time format
- alarm with beep, with snooze function (8 minutes)
- time memory 9 V (6LR61) with battery (not included)
- tapellatas: 230 V~ / 50 Hz / 3 W
- meret: 110 x 45 x 90 mm



LTC 02 Digital alarm clock



- 1,8" Jumbo display with adjustable brightness
- 24 hour time format
- alarm with beep, with snooze function (9 minutes)
- time memory 9 V (6LR61) with battery (not included)
- power supply: 230 V~ / 50 Hz / 4 W
- size: 210 x 85 x 85 mm



OC 02 Digital alarm clock, wood



- white oak veneer
- temperature display °C
- alarm with beep, with snooze function (5 minutes)
- time memory
- reduced brightness 18:00-7:00
- included mains adapter
- power supply: 230 V~ / 50 Hz / 6 V / 200 mAh
- size: 220 x 67 x 100 mm



OC 01 Digital alarm clock, wood



- white oak veneer
- alarm with beep, with snooze function (5 minutes)
- time memory
- reduced brightness 18:00-7:00
- included mains adapter
- power supply: 230 V~ / 50 Hz / 6 V / 200 mAh
- size: 156 x 62 x 62 mm



AWC 30T Wall clock with indoor-outdoor thermometer



- brushed aluminium frame, glass front panel
 - large, clearly legible clock face
 - continuously moving seconds indicator
 - 433,92 MHz outdoor temperature transmitter, max. 60 m range
 - can handle 1 pc of transmitter (included: HCKK 05)
 - temperature measurement range:
indoor: -9 - +50 °C,
outdoor: -20 - +60 °C
 - easy setup
 - power supply 1 x 1,5 V (AA) + 4 x 1,5 V (AAA) batteries (not included)
 - size: Ø30 cm
- The device is suitable for use in the European Union member states.



SWC 30 Wall clock



- plastic frame, glass front panel
- large, clearly legible clock face
- continuously moving seconds indicator
- wall-mountable
- easy setup
- power supply 1 x 1,5 V (AA) battery (not included)



HCP 20 Projection clock

- two separately adjustable projectors
- projects the exact time and temperature onto the wall
- displays indoor temperature: 0 - 50 °C / 0,1 °C
- large display
- alarm, programmable alarm repetition
- continuous projection with mains adapter (recommended MW 3N06)
- power supply: 2 x AA (1,5 V) batteries (not included)
- size of the device/display: 140 x 95 x 36 mm / 63 x 33 mm



RT5400T2

DVB-T/T2 receiver and multimedia player



- for terrestrial, free digital broadcasts
- according to standards MPEG4/MPEG2/H.264/AVC HD
- 1920 x 1080, outstanding receiver sensibility
- images, video and music playback from USB storage
- delays broadcast viewing opportunity
- optional immediate or scheduled USB recording
- 7 day electronic program guide
- teletext visualization
- parental control, child lock
- scheduled switch-off
- 18 language menu; eg. HU, SK, RO, SRB, SL, GB, DE...
- preferred 4:3 and 16:9 aspect ratio
- supported resolutions: 576P/720P/1080i/1080P
- connectors: HDMI, SCART, coaxial digital audio output, RF antenna on/off
- power supply: 230 V~ / 50 Hz / 6 W / 1 W
- size: 168 x 90 x 36 mm



HDC 3500

DVB-C receiver



- Hungarian language menu
- multimedia player and recorder
- MPEG-4 H.264/AVC, MPEG2 compatibility
- 576i/576p/720p/1080i and 16:9/4:3 aspect ratio
- stereo analog audio output for amplifiers
- electronic program guide and Teletext
- optional immediate or scheduled recording to an outer USE device (max. 500 GB)
- playback on the device or on computer (eg. VLC Player)
- size of the recorded file: approx. 45-50 Mb/minute (HD quality)
- HDMI output and composite video output for TV
- remote controller included
- size: 30 x 12,5 x 11 cm



ASP-8

Outdoor antenna with amplifier

max. **37dB**

BUILT-IN amplifier

DVB-T /T2

- excellent for DVB-T signal and nearby TV signal reception
- frequency: 170 MHz - 860 MHz
- polarisation: V/H
- max. amplification: 37 dB (at 600 MHz)
- output impedance: 75 Ω
- power supply: 230 V~ / 50 Hz
- size: 78 x 57 x 22,5 cm

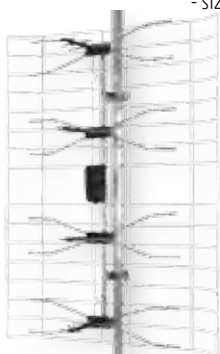

ASP-88T

Mains power unit for ASP-8 antenna

ASP-8S

Outdoor antenna

max. **13dB**

DVB-T /T2

- excellent for DVB-T signal and nearby TV signal reception
- frequency: 170 MHz - 860 MHz
- polarisation: V/H
- gain: 13 dBi (at 600 MHz)
- output impedance: 75 Ω
- size: 78 x 57 x 22,5 cm

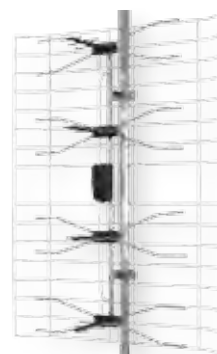

TA 32

Outdoor antenna with amplifier

max. **32dB**

BUILT-IN amplifier

DVB-T /T2

- 4 x GSM 900 MHz signal interference filtering
- frequency range: 470 - 862 MHz
- polarisation: V/H
- number of elements: 20
- instead of an adapter it can be powered from set top box, TV etc. (5-12 V~ / 100 mA)
- output impedance: 75 Ω
- max. amplification: 32 dB (at 600 MHz)
- size: lenght: 400 mm

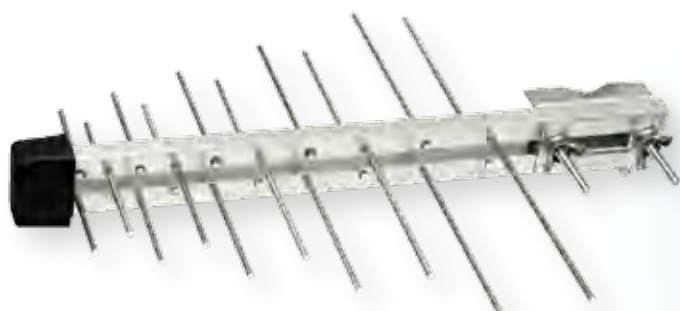

FZ 56

Outdoor antenna with amplifier

max. **56dB**

BUILT-IN amplifier

DVB-T /T2

- extremely high sensitivity
- ideal for radio and TV signal reception
- suitable for receiving analog and digital signals
- wall-mounted holder and metal clamps included
- can be hung, screwed or can be clamped to a pole
- built-in „F” connection socket
- broadcast reception: FM, VHF, UHF
- 87,5-230 MHz, 470-862 MHz
- amplification: max. 56 dB
- output impedance: 75 Ω
- purchase of connection cable is required
- power supply: 12 V~ mains adapter, included
- size: 320 x 30 x 230 mm / 400 g

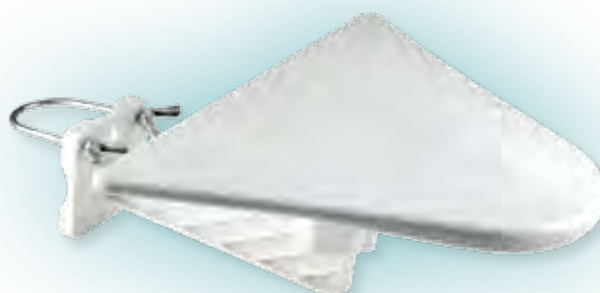

FZ 52 Indoor antenna with amplifier

BUILT-IN
amplifier

DVB-T
/T2

- world breakthrough, the latest technology
- extremely high sensitivity
- paper thin, lightweight
- ideal for receiving radio and TV broadcasts
- suitable for receiving analog and digital signals
- table stand included
- can be stuck on furniture or wall
- broadcast reception: FM, VHF, UHF
- 47-230 MHz, 470-862 MHz
- amplification: max. 52 dB
- output impedance: 75 Ω
- power supply: 12 V \leftarrow mains adapter, included
- can be supplied from the receiver device (5 V \leftarrow)
- size: 230 x 210 mm x 1 (10) mm



FZ 50 Indoor antenna with amplifier

max.
48 dB

BUILT-IN
amplifier

DVB-T
/T2

- ideal for receiving radio and TV broadcasts
- suitable for receiving analog and digital signals
- can be placed on desktop, wall-mountable or can be clamped to a pole
- horizontal or vertical placement
- broadcast reception: FM, VHF, UHF
- amplification: max. 48 dB
- output impedance: 75 Ω
- power supply: from mains socket: 230 V~ / 50 Hz, throughout antenna connection: 5 V (\leftarrow) / 40 mA
- size: 250 x 170 x 32 mm



FZ 45 Indoor antenna with amplifier

max.
45 dB

BUILT-IN
amplifier

DVB-T
/T2

- broadband VHF / UHF / FM reception
- for TV and radio devices
- ideal for DVB-T (digital terrestrial TV broadcast) reception
- tiltable aerial surface + rotatable rod antennas
- built-in adjustable amplifier
- operated by network or accumulator
- amplification: max. 45 dB
- power supply: 230 V~ / 50 Hz with adapter (included): DC 12 V 100 mA
- size: 210 x 230 x 145 mm



FZ 42 Indoor antenna with amplifier

max.
42 dB

BUILT-IN
amplifier

DVB-T
/T2

- broadband VHF / UHF / FM reception
- for TV and radio devices
- ideal for DVB-T (digital terrestrial TV broadcast) reception
- tiltable aerial surface + rotatable rod antennas
- built-in adjustable amplifier
- amplification: max. 42 dB
- power supply: 230 V~ / 50 Hz
- size: 200 x 245 x 185 mm



FZ 3 Indoor antenna with amplifier

max.
32 dB

BUILT-IN
amplifier

DVB-T
/T2

- broadband tv/radio reception
- ideal for DVB-T (digital terrestrial TV broadcast) reception
- built-in adjustable amplifier
- rotatable in 300 degrees
- amplification: max. 32 dB
- power supply: 230 V~
- size: \varnothing 230 mm, height with base: 280 mm



URC 2000AC/SL

Universal remote control for air conditioners

- TURBO COOLING**
- TURBO HEATING**
- SMART SLEEP MODE**
- ON-OFF TIMER**

- 2000 operating codes for more than 10000 types. It can be used for almost all types of air conditioners. It expands your device with new, useful features.
- always displays the temperature of the room
 - exact time is constantly displayed
 - timer programmes; switching on and off
 - intelligent rapid heating and rapid cooling modes
 - SMART sleeping mode with delayed temperature control
 - automatic operating code search
 - manual setup by brand
 - clear, well-readable, large scale display
 - steady blue LED background light
 - supplied with wall bracket
 - power supply: 2 x AAA (1,5 V) batteries (not included)
 - size: 165 x 55 x 20 mm

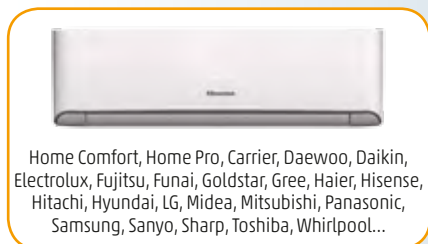

URC 24T

Teachable remote control, for 7 devices

- replaces 7 remote controls at the same time
- blue LCD background light
- preprogrammed and learnable modes
- favorite channel, macro, thermometer, calculator with 4 actions function
- power supply: 2 x 1,5 V (AA) batteries (not included)



URC 23

Universal remote control, for 2 devices

- replaces 2 remote controls at the same time
- preprogrammed codes
- manual code selection or automatic code search
- supplied table stand
- power supply: 2 x 1,5 V (AAA) batteries (not included)
- size: 170 x 45 x 20 mm



URC 22

Universal remote control, for 4 devices

- replaces 4 remote controls at the same time
- preprogrammed codes
- manual code selection or automatic code search
- ergonomic design
- power supply: 2 x 1,5 V (AA) batteries (not included)
- size: 180 x 60 x 25 mm



URC 10

Universal remote control, for 8 devices

- replaces 8 remote controls at the same time
- preprogrammed
- code selection is possible by quick search or by brand
- teletext function
- memory to prevent loss of adjusted codes in case of battery change
- power supply: 2 x AAA [1,5 V] batteries (not included)
- size: 45 x 21 x 182 mm



URC 21

Universal remote control, for 8 devices

- to operate TV, video recorder, satellite receiver, DVD, hifi, cable TV decoder
- can control the basic functions of hundreds of global brands, thousands of devices
- preprogrammed
- memory to prevent loss of adjusted codes in case of battery change
- power supply: 2 x AAA [1,5 V] batteries (not included)
- size: 56 x 185 x 26 mm



URC 20

Universal remote control, for 6 devices

- to operate TV, video recorder, satellite receiver, DVD, hifi, cable TV decoder
- can control the basic functions of hundreds of global brands, thousands of devices
- preprogrammed
- color coded teletext keys
- memory to prevent loss of adjusted codes in case of battery change
- power supply: 2 x AAA [1,5 V] batteries (not included)
- size: 52 x 200 x 25 mm



URC 1

Universal remote control, for 4 devices

- to operate TV, video recorder, satellite receiver, DVD, hifi
- preprogrammed
- code selection is possible by quick search or by brand
- power supply: 2 x AA [1,5 V] batteries (not included)
- size: 44 x 18 x 185 mm



GSH 026

Wall-mounted glass shelf



- to accommodate set-top boxes, game consoles, etc.
- tempered glass
- elegant, unique design
- capacity: max. 8 kg
- accessory mounting brackets
- size: 360 x 250 mm



LCDH 19

Wall mount 37"-70", tiltable



- 37"-70" screen sizes
- capacity: max. 40 kg
- tiltable +/- 12°
- built-in bubble level, accessory mounting brackets
- VESA
200 x 200,
400 x 200,
300 x 300,
400 x 400,
600 x 400

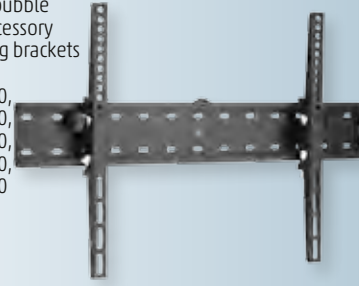

LCDH 18

Wall mount 32"-55", tiltable



- 32"-55" screen sizes
- capacity: max. 40 kg
- tiltable +/- 12°
- built-in bubble level, accessory mounting brackets
- VESA 200 x 200, 400 x 200,
300 x 300, 400 x 400

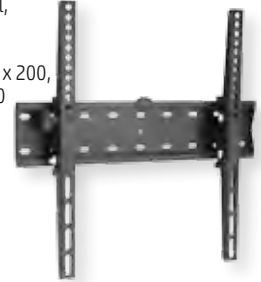

LCDH 08

Wall mount 32"-55", fixed



- 32"-55" screen sizes
- spring loaded automatic mounting, quick release strip
- capacity: max. 40 kg
- built-in bubble level, accessory mounting brackets
- VESA 200 x 200,
400 x 200,
300 x 300,
400 x 400

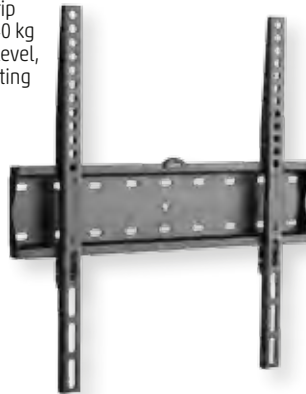

LCDH 07

Wall mount 23"-42", fixed



- 23"-42" screen sizes
- spring loaded automatic mounting, quick release strip
- capacity: max. 30 kg
- built-in bubble level, accessory mounting brackets
- VESA 75 x 75, 100 x 100,
200 x 100, 200 x 200



LCDH 28

Wall mount 32"-55", tiltable, rotatable



- screen sizes: 32" - 55"
- max. capacity: 35 kg
- extensible up to 26 cm, when folded it retracts to 9,2 cm
- built-in bubble level
- accessories: mounting brackets
- VESA 75 x 75, 100 x 100,
200 x 100, 200 x 200,
300 x 300, 400 x 200,
400 x 400



LCDH 27

Wall mount 23"-42", tiltable, rotatable



- screen sizes: 23" - 42"
- max. capacity: 30 kg
- extensible up to 38,7 cm, when folded it retracts to 9 cm
- accessories: mounting brackets
- VESA 50 x 50, 75 x 75,
100 x 100, 200 x 100,
200 x 200



LCDH 02/BK

Wall mount



- for LCD and plasma TV-s, speakers
- capacity: 15 kg
- negotiable arm in 2 points
- tiltable base plate
- viewing angle is adjustable in a wide range
- light aluminium mould construction
- fitting accessories
- base plate conforms to the VESA standard
- black



LCDH 01/BK

Wall mount



- for LCD and plasma TV-s, speakers
- capacity: 15 kg
- negotiable arm in 3 points
- tiltable base plate
- viewing angle is adjustable in a wide range
- light aluminium mould construction
- fitting accessories
- base plate conforms to the VESA standard
- black



NBC 90W

Universal notebook charger

AUTO SWITCH **max. 90 W**

- universal plug kit
- automatic voltage selection
- voltage adjustment based on the plugs
- effective charging; active power factor correction
- protections: reverse polarity, overcurrent, excess voltage, short-circuit
- size: 130 x 60 x 30 mm

Before purchase, check your computers voltage supply, power consumption, and the exact sizes and polarity of the original plug!
ACER, ASUS, COMPAQ, DELL, DELTA, FUJITSU, GATEWAY, HASEE, HP, IBM, LENOVO, LITEON, NEC, TOSHIBA



	M5	19V	5,5 x 2,5 x 12 mm	PRIMER / INPUT					
	M7	19V	5,5 x 2,1 x 12 mm	100 - 240 V~ 50 - 60 Hz 2 A					
	M9	19,5V	7,4 x 5,0 x 12 mm	SECUNDER / OUTPUT +					
	M23	19,5V	4,5 x 3,0 x 10 mm	15V $\overline{\text{m}}$	16V $\overline{\text{m}}$	18,5V $\overline{\text{m}}$	19V $\overline{\text{m}}$	19,5V $\overline{\text{m}}$	20V $\overline{\text{m}}$
	M24	19,5V	4,0 x 1,7 x 12 mm	max.6 A	max.5,6 A	max.4,9 A	max.4,74 A	max.4,62 A	max.4,5 A
	M25	20V	5,5 x 2,5 x 12 mm	max.90 W	max.90 W	max.90 W	max.90 W	max.90 W	max.90 W
	M26	19V	4,0 x 1,35 x 10 mm						
M28	20V	11 x 4,5 x 11 mm							



MW 7H50GS

Universal notebook adapter

5000 mA

- 5000 mA
- 6 / 7,5 / 9 / 12 / 13,5 / 15 V
- 6 types of connectors: 2,5 / 3,5 / 3,5 x 1,35 / 5 x 2,1 / 5,5 x 1,5 / 5,5 x 2,5
- desktop design
- size: 135 x 70 x 37 mm

output voltage	output current
6 / 7,5 / 9 / 12 V	5000 mA
13,5 / 15 V	3800 mA



MW 2P100

Voltage converter

100 Watt

- for operation of devices manufactured for 110 V mains power
- max. 100 W capacity
- desktop design
- suitable for American toys as well
- size: 84 x 70 x 114 mm



SA 2100USB

Adapter with USB socket

2,1 A

- USB connecting cable is required
- high-current fast charge: 2,1 Amper
- input: 100-240 V~ / 50-60 Hz
- USB output: 5 V $\overline{\text{m}}$ / max. 2100 mA

USB
UNIVERSAL SERIAL BUS

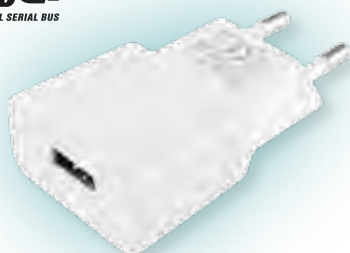

SA 1000USB

Adapter with USB socket

1000 mA

- USB connecting cable is required
- input: 230 V~ / 50 Hz
- USB output: 5 V $\overline{\text{m}}$ / max. 1000 mA

USB
UNIVERSAL SERIAL BUS



NK 120P100

Adapter

1000
mA

12 V DC



- up to 1000 mA power consumption
- output: 12 V $\overline{\text{--}}$
- LED indicator
- with 5,5 x 2,1 mm power supply connector
- EuP compatible



NL 120P050

Adapter

500
mA

12 V DC



- up to 500 mA power consumption
- output: 12 V $\overline{\text{--}}$
- LED indicator
- with 5,5 x 2,1 mm power supply connector
- EuP compatible



NF 120P030

Adapter

300
mA

12 V DC



- up to 300 mA power consumption
- output: 12 V $\overline{\text{--}}$
- LED indicator
- with 5,5 x 2,1 mm power supply connector
- EuP compatible



MW 3IP25

Adapter

2250
mA



- up to 2250 mA power consumption
- adjustable voltage: 3 / 4,5 / 5 / 6 / 7,5 / 9 / 12V
- LED indicator
- accessory: 6 pcs of connectors with optional polarity adjustment
- EuP compatible



MW 3R15

Adapter



1500
mA



- up to 1500 mA power consumption
- adjustable voltage: 3 / 4,5 / 5 / 6 / 7,5 / 9 / 12V
- LED indicator
- accessory: 6 pcs of connectors with optional polarity adjustment
- EuP compatible



MW 3K10

Adapter

1000
mA



- up to 1000 mA power consumption
- adjustable voltage: 3 / 4,5 / 5 / 6 / 7,5 / 9 / 12V
- LED indicator
- accessory: 6 pcs of connectors with optional polarity adjustment
- EuP compatible



MW 3N06

Adapter

600
mA



- up to 600 mA power consumption
- adjustable voltage: 3 / 4,5 / 5 / 6 / 7,5 / 9 / 12V
- LED indicator
- accessory: 6 pcs of connectors with optional polarity adjustment
- EuP compatible



MW 8XC2

Universal adapter connector kit

- with special SONY + PANASONIC plug
- connector plugs: \varnothing 2,5 mm, \varnothing 3,5 mm, 0,75 x 2,35 mm, 1,35 x 3,5 mm, 1,5 x 5,5 mm, 1,7 x 4,0 mm, 2,1 x 5,0 mm, 2,5 x 5,5 mm



adapter

PB 2600/BL

Power Bank with LED flashlight

- blue



- 2in1: emergency charger and high brightness 3 W LED flashlight
- recharge your discharged mobile devices anywhere
- premium quality 2600 mAh / 3,7 V Li-Ion built-in accumulator
- fully automatic recharging
- overcharging, deep discharge, over current and short circuit protection
- 3 coloured indicator LEDs
- high quality aluminium case
- USB/microUSB-B charging cable (1 m) included
- size: Ø30 x 115 mm /98 g



PB 2600/SL

- silver



PB 2500

Power Bank

2500
mAh



- recharge your mobile devices anywhere
- extra flat and lightweight design
- rechargeable in car*, at home* or from notebook
- fully automatic recharging
- overcharging, deep discharge, over current and short circuit protection
- 2 coloured indicator LEDs
- USB/microUSB-B charging cable (1 m) included
- size: 63 x 97 x 7 mm / 53 g
- *the adapter is not a part of the kit

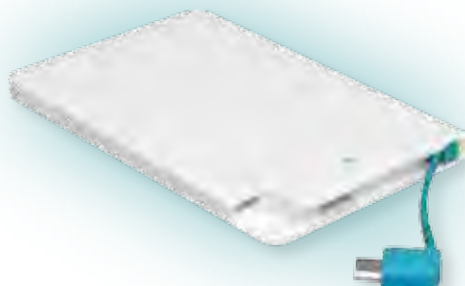

PB 4AA SERIES

Power Bank, battery operated



- 2in1: emergency charger and LED flashlight
- recharge your mobile devices anywhere
- it works with normal batteries distributed in stores
- always ready for use, does not discharge in standby mode like the accumulators
- flashlight with 3 LEDs
- 4 x AA (1,5 V) alkaline batteries needed (not included)
- size: 65 x 82 x 20 mm



PB 4AA/WH

- white

PB 4AA/BK

- black

PB 4AA/BL

- blue

RT 12120

Lead battery

- 12 V/12 Ah
- 151 x 98 x 95 mm
- closed construction
- 5 years service time
- areas of use: alarm systems, medical equipments, uninterruptible power sources, fire protection and security systems, electric children's vehicle...



RT 1270ES

Lead battery

- 12 V/7,0 Ah
- 151 x 94 x 65 mm
- closed construction
- 5 years service time
- areas of use: alarm systems, medical equipments, uninterruptible power sources, fire protection and security systems, electric children's vehicle...



RT 1245E

Lead battery

- 12 V/4,5 Ah
- 90 x 70 x 101 mm
- closed construction
- 5 years service time
- areas of use: alarm systems, medical equipments, uninterruptible power sources, fire protection and security systems, electric children's vehicle...



RT 1213

Lead battery

- 12 V/1,3 Ah
- 97 x 43 x 52 mm
- closed construction
- 5 years service time
- areas of use: alarm systems, medical equipments, uninterruptible power sources, fire protection and security systems, electric children's vehicle...



RT 6120

Lead battery

- 6 V/12 Ah
- 151 x 50 x 94 mm
- closed construction
- 5 years service time
- areas of use: alarm systems, medical equipments, uninterruptible power sources, fire protection and security systems, electric children's vehicle...



RT 645

Lead battery

- 6 V/4,5 Ah
- 70 x 47 x 101 mm
- closed construction
- 5 years service time
- areas of use: alarm systems, medical equipments, uninterruptible power sources, fire protection and security systems, electric children's vehicle...



MW 1222-2GS

Accumulator charger

- suitable for charging NiCd and NiMH accumulators
- for the simultaneous charging of 2 or 4 pcs of mini, type (AAA) or type (AA) accumulators
- LED indicators
- charging current: 120 mA/AA, 54 mA/AAA
- size: 105 x 45 x 53 mm



The accumulator is only an illustration!

TCM 800AAA/RTU

Accumulator, AAA RTU

- tecXUS™
The power of X
- NiMH RTU accumulator
 - type (AAA)
 - 1,2 V/800 mAh
 - 2 pcs/blister



TCM 2300AA/RTU

Accumulator, AA RTU

- tecXUS™
The power of X
- NiMH RTU accumulator
 - type (AA)
 - 1,2 V/2300 mAh
 - 2 pcs/blister



TCM 1100AAA

Accumulator

- tecXUS™
The power of X
- NiMH accumulator
 - type (AAA)
 - 1,2 V/1100 mAh
 - 2 pcs/blister



TCM 2700AA

Accumulator

- tecXUS™
The power of X
- NiMH accumulator
 - type (AA)
 - 1,2 V/2700 mAh
 - 2 pcs/blister



TCM 4500C

Accumulator

- tecXUS™
The power of X
- NiMH accumulator
 - type baby (C)
 - 1,2 V/4500 mAh
 - 1 pc/blister



TCM 10000D

Accumulator

- tecXUS™
The power of X
- NiMH accumulator
 - type goliath (D)
 - 1,2 V/10000 mAh
 - 1 pc/blister



TCM 280-9

Accumulator

- tecXUS™
The power of X
- NiMH accumulator
 - size: 9 V (6LR61)
 - 9 V/280 mAh
 - 1 pc/blister



M 700AAA

Accumulator

- NiMH accumulator
- type (AAA)
- 1,2 V/700 mAh
- 4 pcs/blister



CM 2500AA

Accumulator

- NiMH accumulator
- type (AA)
- 1,2 V/2500 mAh
- 4 pcs/blister



MC 9

Accumulator

- NiMH accumulator
- size: 9 V (6LR61)
- 9 V/120 mAh
- 1 pc/blister



TC LR03 AAA battery

- alkaline
- type (AAA)
- 1,5V
- 4 pcs/blister



TC LR03/6 AAA battery kit

- alkaline
- type (AAA)
- 1,5V
- 24 pcs, XXL pack



TC LR6 AA battery

- alkaline
- type (AA)
- 1,5V
- 4 pcs/blister



TC LR6/6 AA battery kit

- alkaline
- type (AA)
- 1,5V
- 24 pcs, XXL pack



TC LR14 C battery

- alkaline
- baby (C)
- 1,5V
- 2 pcs/blister



TC LR20 D battery

- alkaline
- goliat (D)
- 1,5V
- 2 pcs/blister



TC 6LR61 9V battery

- alkaline
- size: 9V (6LR61)
- 9V
- 1 pc/blister



TC LR23 A23 battery

- alkaline
- size: A 23
- 12V
- 1 pc/blister



TC LR1 LR1 battery

- alkaline
- size: LR 1
- 1,5V
- 1 pc/blister



TC CR 123A CR 123A battery

- lithium
- size: CR 123A
- 3V
- 1 pc/blister



TC CR2016 Button battery

- lithium
- button battery
- 3V
- 1 pc/blister



TC CR2025 Button battery

- lithium
- button battery
- 3V
- 1 pc/blister



TC CR2032 Button battery

- lithium
- button battery
- 3V
- 1 pc/blister



AF LR03 AAA battery



- alkaline
- type (AAA)
- 1,5V
- 4 pcs/blister

AF LR23A A23 battery



- alkaline
- size: A23
- 12V
- 5 pcs/blister

AF R03 AAA battery



- semi-permanent
- type (AAA)
- 1,5V
- 4 pcs/pack

AF LR6 AA battery



- alkaline
- type (AA)
- 1,5V
- 4 pcs/blister

AF LR27A A27 battery



- alkaline
- size: A27
- 12V
- 5 pcs/blister

AF R6 AA battery



- semi-permanent
- type (AA)
- 1,5V
- 4 pcs/pack

AF LR14 C battery



- alkaline
- baby (C)
- 1,5V
- 2 pcs/blister

AF R14 C battery



- semi-permanent
- baby (C)
- 1,5V
- 2 pcs/pack

AF LR20 D battery



- alkaline
- goliath (D)
- 1,5V
- 2 pcs/blister

AF R20 D battery



- semi-permanent
- goliath (D)
- 1,5V
- 2 pcs/pack

AF 6LR61 9V battery



- alkaline
- size: 6LR61
- 9V
- 1 pc/blister

AF 6R61 9V battery



- semi-permanent
- size: 6R61
- 9V
- 1 pc/pack

AF CR123 CR123 battery



- lithium
- size: CR123
- 3V
- 1 pc/blister

AF 3R12 Flat battery



- semi-permanent
- flat battery (3R12)
- 4,5V
- 1 pc/blister

AF 3LR12 Flat battery



- alkaline
- flat battery 3LR12
- 4,5V
- 1 pc/blister

AF CR Button battery

- lithium
- button battery
- 3V
- 5 pcs/blister

AF AG Button battery

- alkaline
- button battery
- 1,5V
- 10 pcs/blister

- AF CR1220
- AF CR2016
- AF CR1620
- AF CR2025
- AF CR2032
- AF CR2430
- AF CR2450



- AF AG0
- AF AG1
- AF AG3
- AF AG4
- AF AG5
- AF AG8
- AF AG10
- AF AG12
- AF AG13



AC 04/4

Travel adapter kit



- can be used in more than 140 countries worldwide
- different colours - different types of adapters
- 100 V - 250 V~ / 2,5 A - 6 A
- 100 V~ / 250 W - 600 W
- 250 V~ / 575 W - 1380 W
- does not convert voltage



AC 05

Travel adapter kit, grounded (Swiss, British, American, Australian, Italian)

- can be used in more than 140 countries worldwide
- grounded (GS) socket
- 5 types of interchangeable (IT, AUS, USA, UK, CH) sockets
- 100 - 250 V~ / 7 A / max. 1750 W
- does not convert voltage



1.500211

Travel adapter, grounded, "World to Europe"

- Swiss design
- it makes more than 150 countries devices suitable for use in Europe
- suitable for grounded and not grounded (3 and 2 contact) devices
- accepts the following connector plugs: Swiss, Italian, Australian/Chinese, UK, USA
- the travel adapter is suitable to connect European sockets (GS and French)
- 220 - 240 V~ / 16 A / max. 3680 W
- does not convert voltage



AC 03

Travel adapter, American

- EURO - US adapter
- makes it possible to use European devices in the USA
- 250 V~ / 2500 W; 125 V~ / 1250 W (max. 10 A)
- does not convert voltage

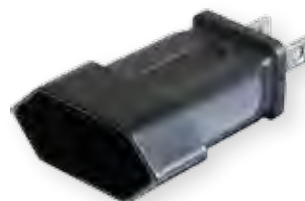

AC 02/US

Travel adapter, grounded, American

- GS - US adapter
- makes it possible to use European devices in the USA
- 250 V~ / 2500 W; 125 V~ / 1250 W (max. 10 A)
- does not convert voltage



AC 02/UK

Travel adapter, grounded, British

- GS - UK adapter
- makes it possible to use European devices in Great Britain
- 250 V~ / max. 1150 W (max. 5 A)
- does not convert voltage



AC 02/IT

Travel adapter, grounded, Italian

- GS - IT adapter
- makes it possible to use European devices in Italy
- 250 V~ / max. 2500 W (max. 10 A)
- does not convert voltage



AC 02/CH

Travel adapter, grounded, Swiss

- GS - CH adapter
- makes it possible to use European devices in Switzerland
- 250 V~ / max. 2500 W (max. 10 A)
- does not convert voltage



	The plug of the electric device to be connected										The type of the outlet					
											EUROPE	UK	USA	AUS	IT	CH
AC 02/US	X	X											X			
AC 02/UK	X	X										X				
AC 02/IT	X	X												X		
AC 02/CH	X	X														X
AC 03		X											X			
AC 04/4		X						X			X	X	X			
AC 05	X	X										X	X	X	X	X
1.500211		X	X	X	X	X	X	X	X	X	X					
1.302150		X		X		X		X			X	X	X	X	X	X

You can find actual information about the electric outlets and voltage of the country in question at the following link below:
http://hu.wikipedia.org/wiki/Elektromos_halozatok_es_csatlakozok_listaja

Whether if it's used for mowing, in office-, home-, even wet environment you will find the one that meet your needs in our range of network products. There are various design, indoor and outdoor cable reels, distributors, extenders, adapters, surge-protected products to choose from. In addition to the conventional ready-made products we recommend the mounted product line, which includes distributors with or without a switch.

Cable reel, distributor, extension cord, accessory



HJR 10-50

Cable reel 25/30/50 m rubbered cable



- can be used also if cable is coiled
- 4 shockproof sockets with lid
- restorer button to delete the deployed thermal protection
- for outdoor use as well (IP44 protected)
- H07RN-F 3G1,5 mm² cable, IP44 outdoor design
- with 50 m cable
- 250 V~ / max. 3000 W - unwound
max. 1000 W - coiled

HJR 10-30

- H07RN-F 3G1,5 mm² cable, IP44 outdoor design
- with 30 m cable
- 250 V~ / max. 3000 W - unwound
/ max. 1000 W - coiled

HJR 10-25/1,0

- H07RN-F 3G1,0 mm² cable, IP44 outdoor design
- with 25 m cable
- 250 V~ / max. 2300 W - unwound
/ max. 900 W - coiled

With metal base, rubber cable!

HJR 4-50

Cable reel with 25/40/50 m cable



- can be used also if cable is coiled
- pipe-shaped plugs, 4 shockproof sockets
- restorer button to delete the deployed thermal protection
- H05VV-F 3G1,5 mm² cable, IP20 design
- with 50 m cable
- 250 V~ / max. 3000 W - unwound / max. 1000 W - coiled

With metal base!



HJR 4-40

- H05VV-F 3G1,0 mm² cable, IP20 design
- with 40 m cable
- 250 V~ / max. 2300 W - unwound / max. 900 W - coiled

HJR 4-25

- H05VV-F 3G1,0 mm² cable, IP20 design
- with 25 m cable
- 250 V~ / max. 2300 W - unwound / max. 900 W - coiled



HJR 10-15

Cable reel with 15 m rubbered cable



- H07RN-F 3G1,5 mm² cable, IP44 outdoor design
- can be used coiled: 250 V~ / max. 1000 W - coiled 250 V~ / max. 2390 W - unwound
- 4 shockproof sockets with lid
- restorer button to delete the deployed thermal protection
- for outdoor use as well (IP44 protected)

With plastic holder!



HJR 3-20

Cable reel with 20 m cable



- H05VV-F 3G1,0 mm² cable, IP20 design
- can be used coiled: 250 V~ / max. 1000 W - coiled 250 V~ / max. 2300 W - unwound
- pipe-shaped plug, 4 shockproof sockets
- restorer button to delete the deployed thermal protection

With plastic holder!



HJR 3-10

Cable reel with 10 m cable



- H05VV-F 3G1,0 mm² cable, IP20 design
- can be used coiled: 250 V~ / max. 1000 W - coiled 250 V~ / max. 2300 W - unwound
- pipe-shaped plug, 4 shockproof sockets
- restorer button to delete the deployed thermal protection

With plastic holder!



HJR 24-30

Cable reel with 27+3 m cable

- We recommend this product in the cases when we don't want to place the cable reel next to the equipment which we would like to operate.
- H05VV-F 3G1,0 mm² cable, IP20 design
 - 27 + 3 meter cable on the big and small rewinder reel
 - can be used coiled: 250 V~ / max. 900 W - coiled 250 V~ / max. 2300 W - unwound
 - pipe-shaped plug and straight jack swing
 - restorer button to delete the deployed thermal protection

With plastic holder!





NV 5-10/G

Extension cord



- H05RN-F 3G1,0 mm² cable, IP44 outdoor design
- lid on the socket
- 250 V~/ 10 A/ 2300 W
- 10 m



NV 7-10/GY

Extension cord



- H07RN-F 3G1,5 mm² cable, IP44 outdoor design
- lid on the socket
- 250 V~/ 16 A/ 3500 W
- 10 m



NV 5-20/G

- 250 V~/ 10 A/ 2300 W
- 20 m

NV 7-20/GY

- 250 V~/ 16 A/ 3500 W
- 20 m

NV 5-30/G

- 250 V~/ 10 A/ 2300 W
- 30 m

NV 7-30/GY

- 250 V~/ 16 A/ 3500 W
- 30 m



Extension cord

- pipe-shaped plug and straight jack swing
- 250 V~/ 10 A/ 2300 W



1



2



3



picture	type	cable, design	length	colour
1	NV 2-3/W	H05VV-F 3G1,0 mm ² cable, IP20 design	3 m	white
1	NV 2-5/W	H05VV-F 3G1,0 mm ² cable, IP20 design	5 m	white
2	NV 2-5/O	H05VV-F 3G1,0 mm ² cable, IP20 design	5 m	orange
3	NV 2-5/G	H05VV-F 3G1,0 mm ² cable, IP20 design	5 m	green
1	NV 2-10/W	H05VV-F 3G1,0 mm ² cable, IP20 design	10 m	white
2	NV 2-10/O	H05VV-F 3G1,0 mm ² cable, IP20 design	10 m	orange
3	NV 2-10/G	H05VV-F 3G1,0 mm ² cable, IP20 design	10 m	green
1	NV 2-20/W	H05VV-F 3G1,0 mm ² cable, IP20 design	20 m	white
2	NV 2-20/O	H05VV-F 3G1,0 mm ² cable, IP20 design	20 m	orange
1	NV 2-30/W	H05VV-F 3G1,0 mm ² cable, IP20 design	30 m	white
2	NV 2-30/O	H05VV-F 3G1,0 mm ² cable, IP20 design	30 m	orange

N 1-2WH/VDE

Power cable

- 2 m
- 2 x 0,75 mm² power cord
- 250 V~/2,5 A
- white

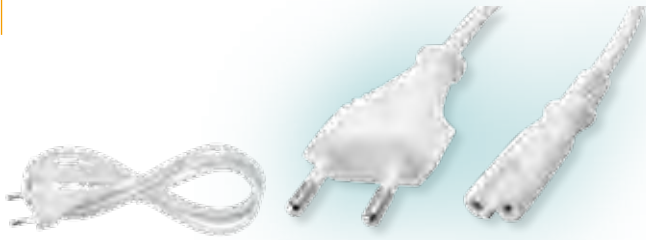

N 2K-2/WH

Power cable with switch

- H03VWH2-F 2 x 0,75 mm²
- 250 V~/ 50 Hz / max. 2 A / max. 460 W
- 2 m (1,5 m+0,5 m)
- with unipolar switch



N 1/VDE

Power cable

- 250 V~/ 2,5 A / 500 W
- 1,5 m
- 2 x 0,75 mm² power cord



N 11/VDE

Power cable

- 250 V~/ 2,5 A / 500 W
- 1,5 m
- 2 x 0,5 mm² power cord



N 2/VDE

Power cable

- 250 V~/ 2,5 A / 500 W
- with tinned end
- 2 x 0,75 mm² power cord
- 1,5 m



N 5

Power cable

- grounded
- 3 x 0,75 mm² hálózati power cord
- 250 V~/ 6 A / 1380 W
- 2 m



N 7

Power cable

- grounded
- 3 x 0,75 mm² power cord
- 250 V~/ 6 A / 1380 W
- 2 m



N 8-3/1,5

Power cable

- H05RR-F 3 x 1,5 mm² rubber cable
- IP44 connector plug
- grounded
- 250 V~/ 50 Hz / max. 16 A / max. 3680 W
- 3 m



N 8-5/1,5

Power cable

- H05RR-F 3 x 1,5 mm² rubber cable
- IP44 connector plug
- grounded
- 250 V~/ 50 Hz / max. 16 A / max. 3680 W
- 5 m



N 10-3/1,0

Power cable

- H05RN-F 2 x 1,0 mm² rubber cable
- IP44 connector plug
- 250 V~/ 50 Hz / max. 10 A / max. 2300 W
- 3 m



N 10-5/1,0

Power cable

- H05RN-F 2 x 1,0 mm² rubber cable
- IP44 connector plug
- 250 V~/ 50 Hz / max. 10 A / max. 2300 W
- 5 m



NVO 05K/BK

Power distributor with switch

- 250 V~ / 50 Hz / 16 A / 3500 W
- 1,5 m

- H05RN-F 3G1,0 mm² cable, IP44 outdoor design
- suitable for the safe use of outdoor devices
- lid for all sockets
- massive, solid rubber cable
- fitted with 5 childproof sockets
- size: 390 x 75 x 60 mm



NVO 03K/BK

Power distributor with switch

- 250 V~ / 50 Hz / 16 A / 3500 W
- 1,5 m

- H05RN-F 3G1,0 mm² cable, IP44 outdoor design
- suitable for the safe use of outdoor devices
- lid for all sockets
- massive, solid rubber cable
- fitted with 3 childproof sockets



NVO 05K-5/BK

- 250 V~ / 50 Hz / 10 A / 2300 W
- 5 m



NVO 03K-5/BK

- 250 V~ / 50 Hz / 10 A / 2300 W
- 5 m



NV MS 2+6

Power distributor with switch

- suitable to protect household appliances
- 1 master and 6 slave sockets, with teachable power switch and indicator light
- 1 normal socket, independent from the master
- overload protection
- 27000 Amper surge protection: for TV, DVB-T, modem, telephone, LAN and grounded sockets
- USB recharging sockets (5 V - total 1000 mA)
- for indoor use (IP20)



NV MS 5

Power distributor with switch

- 4 pcs of slave sockets with USB controller (master)
- 1 pc of socket, independent from the USB control (ON)
- 1,5 m USB cable
- suitable for surge protection of household appliances up to 4 kV
- for indoor use (IP20)
- wall mountable
- 1,8 m H05VV-F 3G1,5 mm²
- 250 V~ / 50 Hz / 16 A / max. 3500 W



NVT 06K/WH

Power distributor with switch

- 6 sockets
- 1,5 m cable



- H05VV-F 3G1,5 mm² cable, IP20 design
- suitable to protect household appliances
- overload protection up to 4500 A
- fitted with childproof sockets
- switch
- 250 V~ / 50 Hz / 16 A / 3500 W



NVP 03K/WH

- 3 sockets
- 2 m cable
- can be hung on the wall



NVT 04K/WH

- 4 sockets
- 1,5 m cable

NVP 06K/WH

- 6 sockets
- 2 m cable
- can be hung on the wall

NVK SERIES

Power distributor with switch

- individually switchable sockets
- 250 V~ / 16A / 3500 W
- total power cut with the main switch
- restorer button to delete the deployed thermal protection



picture	type	number of sockets	cable	length of the cable	colour
1	NVK 03K/WH	3	3 x 1,0 mm ²	1,5 m	white
1	NVK 03K-3/WH/1,5	3	3 x 1,5 mm ²	3 m	white
2	NVK 06K/WH	6	6 x 1,0 mm ²	1,5 m	white
1	NVK 06K-3/WH/1,5	6	6 x 1,5 mm ²	3 m	white

PNV 06K-90/WH

Power distributor with switch



- H05VV-F 3G1,0 mm² cable, IP20 design
- 250 V~ / 16 A / 3500 W
- 6 sockets
- 2 m cable
- frame can be hung on the wall



PNV 04K/WH

Power distributor with switch

- 4 sockets
- 2 m cable
- frame can be hung on the wall



- H05VV-F 3G1,0 mm² cable, IP20 design
- 250 V~ / 16 A / 3500 W



PNV 06K/WH

- 6 sockets
- 2 m cable
- frame can be hung on the wall



PNV 08K/WH

- 8 sockets
- 2 m cable
- frame can be hung on the wall



PNV 10K/WH

- 10 sockets
- 2 m cable
- frame can be hung on the wall

Power distributor with switch

- H05VV-F 3G1,0 mm² cable, IP20 design
1,5 m cable length: 250 V~ / 16 A / 3500 W
3 and 5 m cable length: 250 V~ / 10 A / 2300 W
- H05VV-F 3G1,5 mm² cable, IP20 design
3 and 5 m cable length: 250 V~ / 16 A / 3500 W

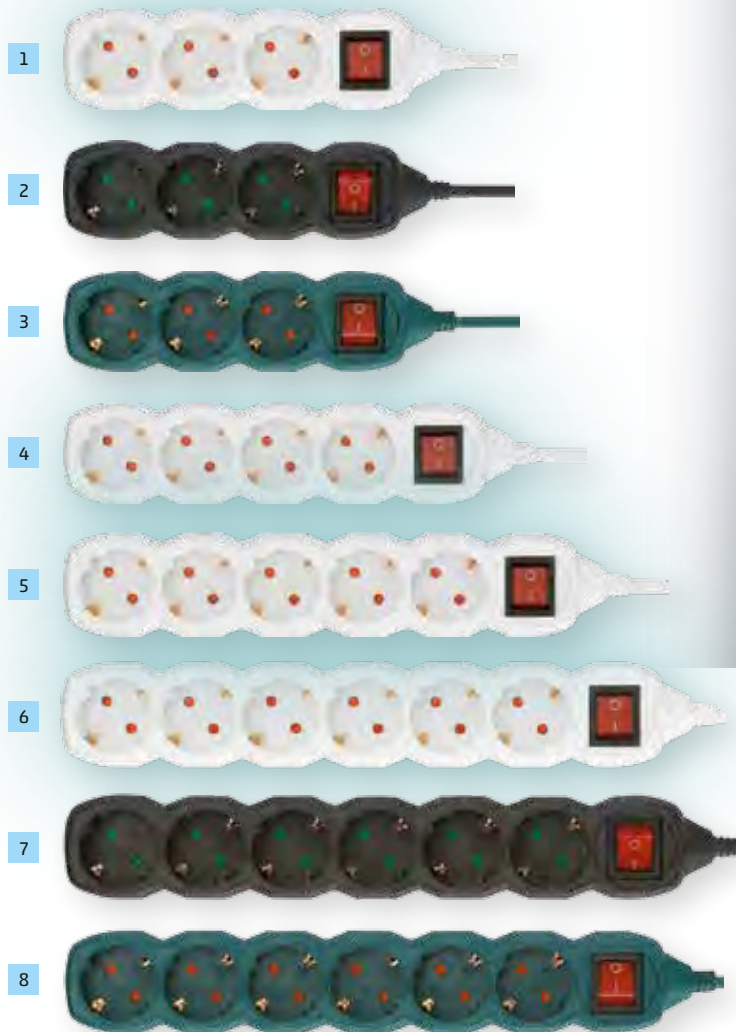

power distributor

picture	type	number of sockets	cable	length of the cable	colour
1	NV 03K/WH	3	3 x 1,0 mm ²	1,5 m	white
2	NV 03K/BK	3	3 x 1,0 mm ²	1,5 m	black
1	NV 03K-3/W	3	3 x 1,0 mm ²	3 m	white
1	NV 03K-3/WH/1,5	3	3 x 1,5 mm ²	3 m	white
1	NV 03K-5/WH/1,5	3	3 x 1,5 mm ²	5 m	white
2	NV 03K-3/B	3	3 x 1,0 mm ²	3 m	black
3	NV 03K-3/G	3	3 x 1,0 mm ²	3 m	green
1	NV 03K-5/W	3	3 x 1,0 mm ²	5 m	white
3	NV 03K-5/G	3	3 x 1,0 mm ²	5 m	green
4	NV 04K/WH	4	3 x 1,0 mm ²	1,5 m	white
4	NV 04K-3/W	4	3 x 1,0 mm ²	3 m	white
5	NV 05K/WH	5	3 x 1,0 mm ²	1,5 m	white
5	NV 05K-3/W	5	3 x 1,0 mm ²	3 m	white
6	NV 06K/WH	6	3 x 1,0 mm ²	1,5 m	white
7	NV 06K/BK	6	3 x 1,0 mm ²	1,5 m	black
6	NV 06K-3/W	6	3 x 1,0 mm ²	3 m	white
6	NV 06K-3/WH/1,5	6	3 x 1,5 mm ²	3 m	white
7	NV 06K-3/B	6	3 x 1,0 mm ²	3 m	black
8	NV 06K-3/G	6	3 x 1,0 mm ²	3 m	green
6	NV 06K-5/W	6	3 x 1,0 mm ²	5 m	white
6	NV 06K-5/WH/1,5	6	3 x 1,5 mm ²	5 m	white
8	NV 06K-5/G	6	3 x 1,0 mm ²	5 m	green
9	NV 17/WH	3 x grounded sockets - 4 euro sockets	3 x 1,0 mm ²	1,5 m	white

Power distributor

- H05VV-F 3G1,0 mm² cable, IP20 design
1,5 m cable length: 250 V~ / 16 A / 3500 W
3 and 5 m cable length: 250 V~ / 10 A / 2300 W
- H05VV-F 3G1,5 mm² cable, IP20 design
3 and 5 m cable length: 250 V~ / 16 A / 3500 W

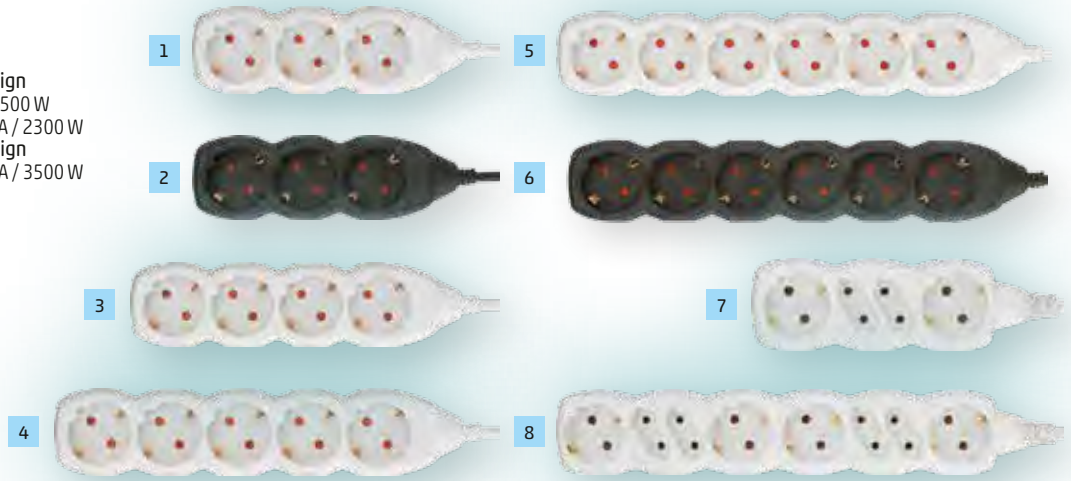

picture	type	number of sockets	cable	length of the cable	colour
1	NV 03/WH	3	3 x 1,0 mm ²	1,5 m	white
2	NV 03/BK	3	3 x 1,0 mm ²	1,5 m	black
1	NV 03-3/W	3	3 x 1,0 mm ²	3 m	white
1	NV 03-3/WH/1,5	3	3 x 1,5 mm ²	3 m	white
1	NV 03-5/WH/1,5	3	3 x 1,5 mm ²	5 m	white
2	NV 03-3/B	3	3 x 1,0 mm ²	3 m	black
1	NV 03-5/W	3	3 x 1,0 mm ²	5 m	white
3	NV 04/WH	4	3 x 1,0 mm ²	1,5 m	white
3	NV 04-3/W	4	3 x 1,0 mm ²	3 m	white
4	NV 05/WH	5	3 x 1,0 mm ²	1,5 m	white
4	NV 05-3/W	5	3 x 1,0 mm ²	3 m	white
5	NV 06/WH	6	3 x 1,0 mm ²	1,5 m	white
6	NV 06/BK	6	3 x 1,0 mm ²	1,5 m	black
5	NV 06-3/W	6	3 x 1,0 mm ²	3 m	white
5	NV 06-3/WH/1,5	6	3 x 1,5 mm ²	3 m	white
5	NV 06-5/WH/1,5	6	3 x 1,5 mm ²	5 m	white
6	NV 06-3/B	6	3 x 1,0 mm ²	3 m	black
5	NV 06-5/W	6	3 x 1,0 mm ²	5 m	white
7	NV 14/WH	2 x grounded sockets - 2 x euro sockets	3 x 1,0 mm ²	1,5 m	white
7	NV 14-3/W	2 x grounded sockets - 2 x euro sockets	3 x 1,0 mm ²	3 m	white
8	NV 18/WH	4 x grounded sockets - 4 x euro sockets	3 x 1,0 mm ²	1,5 m	white
8	NV 18-3/W	4 x grounded sockets - 4 x euro sockets	3 x 1,0 mm ²	3 m	white

Power distributor, mountable

- 250 V~ / 16 A / 3500 W
- power distributors without switch can be hung on the wall
- the power strips without a switch can be hung on the wall
- only can be powered with 3 x 1,5 mm² cable
- connection only can be carried out by a professional!

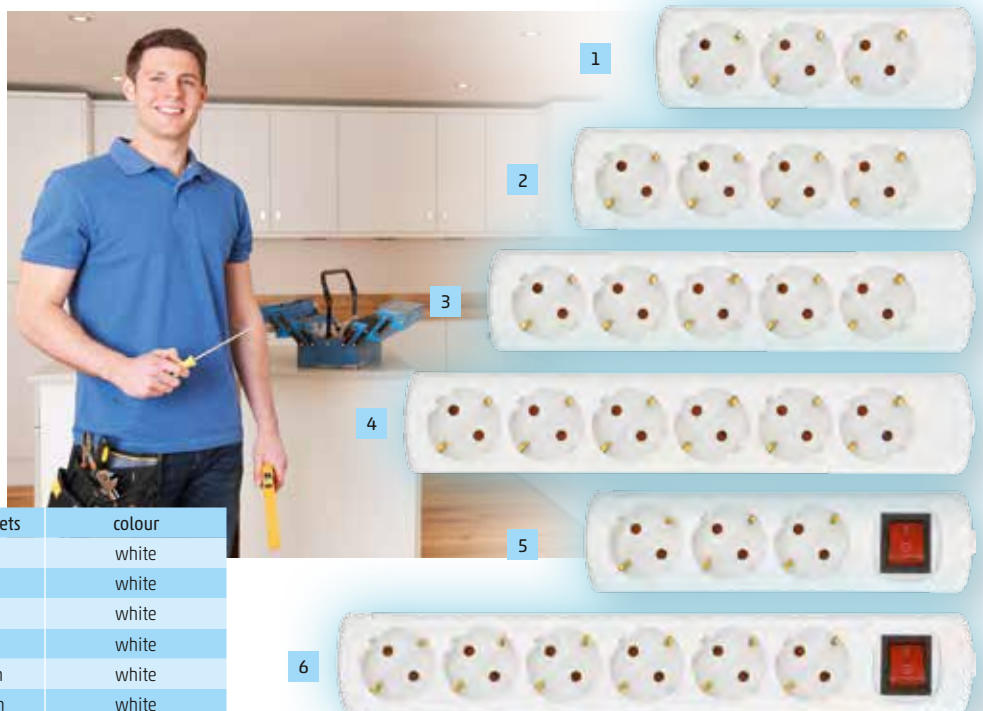

picture	type	number of sockets	colour
1	NV 03	3	white
2	NV 04	4	white
3	NV 05	5	white
4	NV 06	6	white
5	NV 03K	3, with switch	white
6	NV 06K	6, with switch	white

NV 22 Power distributor

- 2 grounded sockets
- 250 V~ / max. 16 A / max. 3500 W



NV 22-90 Power distributor

- 2 grounded sockets, rotatable in 90° degrees
- 250 V~ / max. 16 A / max. 3500 W



TDF 5 Power distributor T-shape

- The side sockets allows to connect two-two euro sockets instead of one-one grounded sockets, so you can connect five devices at the same time.
- 3 grounded sockets, rotatable in 90° degrees
 - 1 grounded + 4 euro sockets
 - total. max.: 250 V~ / 16 A / 3500 W



TPF-26 Power distributor T-shape

- 3 grounded sockets
- 250 V~ / max. 16 A / max. 3680 W
- white



TPF-26/GR Power distributor T-shape

- 3 grounded sockets
- 250 V~ / max. 16 A / max. 3680 W
- green



NV 13/WH Power distributor, 3 sockets

- 1 grounded socket (250 V~ / 16 A / 3500 W)
- 2 euro sockets (250 V~ / 2 x 2,5 A / 2 x 500 W)
- total max.: 250 V~ / 16 A / 3500 W



NV 24/WH Power distributor

- 4 euro sockets
- 250 V~ / 4 x 2,5 A / 4 x 500 W



NV 23/WH Power distributor

- 3 euro sockets
- 250 V~ / 3 x 2,5 A / 3 x 500 W

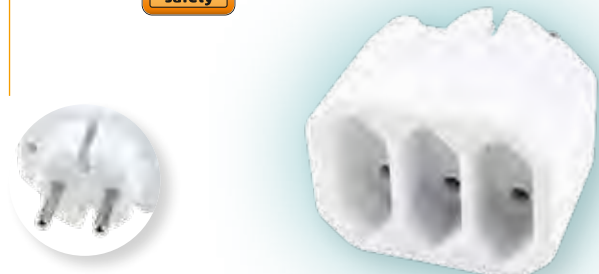

NV 1/WH Power distributor

- 2 euro sockets
- 250 V~ / 2 x 2,5 A / 2 x 500 W



NVK 1/WH Network connection socket, with switch

 - allows turning electric devices on and off safely
- rimmed design for ease of use
- with child protection
- switch
- for indoor use (IP20)
- 250 V ~ / 50 Hz / 16 A / 3500 W
- size: 53 x 74 x 79 mm



NVK 3/WH Network connection socket, with switch

 - allows turning electric devices on and off safely
- 2 pcs of euro + 1 pc of grounded socket
- 3 socket fitted with child protection
- switch
- for indoor use (IP20)
- 250 V ~ / 50 Hz / 16 A / 3500 W



NVT 1/WH Network connection socket, with surge protection

 - suitable to protect household appliances
- surge protection up to 4500 A
- with child protection
- for indoor use (IP20)
- 250 V ~ / 50 Hz / 16 A / 3500 W
- size: 53 x 74 x 79 mm



0795S Grounded plug with illuminated switch

- white
- 16 A



NV FP 2 Grounded plug, extra flat

- 250 V ~ / max. 16 A / max. 3500 W



MONOBLOK Grounded plug with lateral cable outlet

- 2P+grounded
- 250 V ~ / 50 Hz, max. 16 A / max. 3500 W



DO-16 Grounded plug, with lateral cable outlet

- 2 poles + protective contact
- 250 V ~ / 16 A / 3500 W
- lateral cable outlet



0115S Grounded plug, with lateral cable outlet

- white
- 10 A



0101S Grounded plug, with central cable outlet

- white
- 10 A



0142H Grounded plug, with central cable outlet

- black
- 10 A



0201S Grounded swinging socket

- white
- 10 A



NV 10 Child-proof safety lock

- white
 - suitable for use in all sockets with protective ground contact
- prevent direct contact with the live components
- 6 pcs/pack

6 x 

6 x 

NV 10T
- transparent

TH 1 Remote controllable power socket

433,9
MHz



- for expanding the TH 111 and TH 113 remote controllable systems marketed by SOMOGYI ELEKTRONIC
- range in open space: 25 m
- LED indicator, child lock
- power supply: 250 V ~ / 50 Hz / 1150 W
- size: 105 x 55 x 42 mm



TH 111 Remote controllable power socket kit

433,9
MHz



- 1 pc of socket, 1 pc of remote control
- range in open space: 25 m
- one remote control can handle 5 different sockets (A, B, C, D, E)
- expandable system: 32 adjustable channels
- LED indicator
- power supply of the remote control: 1 x 23A (12 V) battery (included)
- size: socket: 105 x 55 x 42 mm
remote control: 115 x 37 x 17 mm



TH 113 Remote controllable power socket kit

433,9
MHz



- 3 pcs of sockets, 1 pc of remote control
- range in open space: 25 m
- one remote control can handle 5 different sockets (A, B, C, D, E)
- expandable system: 32 adjustable channels
- LED indicator
- power supply of the remote control: 1 x 23A (12 V) battery (included)
- size: socket: 105 x 55 x 42 mm
remote control: 115 x 37 x 17 mm



TD 10 Digital outdoor weekly timer



- for outdoor use as well (IP 44 protected)
- 1 minute setting interval, weekly programming option
- 8 adjustable programmes
- daily programme repeat function (16 combinations)
- randomly programmed timer for home safety
- manual on/off function
- memory protection with built-in accumulator
- 250 V ~ / 16 A / 3500 W
- size: 140 x 60 x 45 mm



TS MD 5 Outdoor daily timer



- daily programming
- 15 minute intervals
- IP44: protected against splashing water
- 250 V ~ / 50 Hz / max. 16 (2) A / max. 3680 (460) W



TD 022 Digital indoor weekly timer

- 9 daily programmes, 15 different day combinations, weekly repeat
- 1 sec min. interval
- randomly programmed timer for home safety
- manual on/off function
- memory protection with built-in accumulator
- with countdown (max. 100 h)
- 250 V~ / 50 Hz / max. 16 (2) A / max. 3680 (460) W



TD 02 Digital indoor weekly timer



- 1 minute interval, weekly programming option
- 8 adjustable, 16 pre-set programmes
- daily programme repeat
- randomly programmed timer for home safety
- manual on/off function
- memory protection with built-in accumulator
- 250 V~ / 16 A / 3500 W
- size: 130 x 57 x 40 mm



TD 01 Digital indoor weekly timer



- 1 minute interval, weekly programming option
- 8 adjustable programmes
- daily programme repeat (16 combinations)
- randomly programmed timer for home safety
- manual on/off function
- memory protection with built-in accumulator
- 250 V~ / 16 A / 3500 W
- size: 75 x 75 x 40 mm



TG 4 Mechanical indoor weekly timer



- pre-programming a week
- continuous, 2 hour intervals
- weekly repeated programmes
- manual switch on function
- indicator LED
- 250 V~ / 16 A / 3500 W
- size: 115 x 70 x 40 mm



TG 3 Mechanical indoor timer



- 24-hour programmable, continuous, 15 minute intervals
- daily repeated programmes
- manual switch on function
- indicator LED
- 250 V~ / 16 A / 3500 W
- size: 115 x 70 x 40 mm



0760S Mechanical indoor timer 24h/30min

- 30 minute intervals
- manual switch on function
- daily repeated programmes
- 250 V~ / 16 A / 3500 W



EM 03 Power meter, with memory



- continuously controllable consumption and cost
- wide range of measurement limits, with high accuracy
- display of output, voltage, current, frequency and costs of consumption
- operation time measurement
- note of maximum and minimum consumption
- light signal in case of overloading
- blue LCD background light
- with memory, it keeps the adjusted value, time and date even when power supply is terminated
- size: 110 x 52 x 30 mm



Surface-mounted outdoor switch family

IT WATER IP54



pic.	type	denomination, features
1	9853H	Grounded socket, outdoor IP54 design, 230 V~ / 50 Hz / 16 A, classifiable with special joint
2	9854H	2 seat grounded socket, outdoor IP54 design, 230 V~ / 50 Hz / 16 A, classifiable with special joint
3	9855H	Changeover switch, outdoor IP54 design, 230 V~ / 50 Hz / 10 A, classifiable with special joint

pic.	type	denomination, features
3	9852H	Push switch, outdoor IP54 design, 230 V~ / 50 Hz / 10 A, classifiable with special joint
4	9851H	2-pole switch, outdoor IP54 design, 230 V~ / 50 Hz / 10 A, classifiable with special joint
5	9850H	Chandelier switch, outdoor IP54 design, 230 V~ / 50 Hz / 10 A, classifiable with special joint

Surface-mounted outdoor products

BUSINESS LINE IP54



pic.	type	denomination, features
1	9567H	1 seat grounded socket, with transparent lid, outdoor IP54 design, 230 V~ / 50 Hz / 16 A
2	9568H	2 seat grounded socket, with transparent lid, outdoor IP54 design, 230 V~ / 50 Hz / 16 A
3	9560H	Changeover switch, outdoor IP54 design, 230 V~ / 50 Hz / 10 A

Surface-mounted outdoor products

AQUASTAR IP44



pic.	type	denomination, features
1	22111	Grounded socket, outdoor IP44 design, white-smoke, 230 V~ / 50 Hz / 16 A
2	22121	2 seat grounded socket, outdoor IP44 design, white-smoke, 230 V~ / 50 Hz / 16 A
3	22131	3 seat grounded socket, outdoor IP44 design, white-smoke, 230 V~ / 50 Hz / 16 A
4	22141	Grounded socket, outdoor IP44 design, white, 230 V~ / 50 Hz / 16 A
5	22151	2 seat grounded socket, outdoor IP44 design, white, 230 V~ / 50 Hz / 16 A
6	22161	3 seat grounded socket, outdoor IP44 design, white, 230 V~ / 50 Hz / 16 A

pic.	type	denomination, features
7	22031	Chandelier switch, outdoor IP44 design, white, 230 V~ / 50 Hz / 10 A
8	22041	Changeover switch, outdoor IP44 design, white, 230 V~ / 50 Hz / 10 A
9	22081	1-pole switch, outdoor IP44 design, white, 230 V~ / 50 Hz / 10 A
10	22061	Push switch with bell symbol, outdoor IP44 design, white, 230 V~ / 50 Hz / 10 A
11	22181	2-pole switch, outdoor IP44 design, white, 230 V~ / 50 Hz / 10 A

Surface-mounted indoor products

NOVA IP20



pic.	type	denomination, features
1	0327H	1 seat grounded socket, for indoor use, 230 V~ / 50 Hz / 16 A
2	0328H	2 seat grounded socket, for indoor use, 230 V~ / 50 Hz / 16 A
3	0329H	4 seat grounded socket, for indoor use, 230 V~ / 50 Hz / 16 A

pic.	type	denomination, features
4	0325H	Changeover switch, indoor design, 230 V~ / 50 Hz / 10 A
4	0326H	Bell push switch, indoor design, 230 V~ / 50 Hz / 10 A
5	0330H	Chandelier switch, indoor design, 230 V~ / 50 Hz / 10 A

Surface-mounted indoor products

BUSINESS LINE IP20

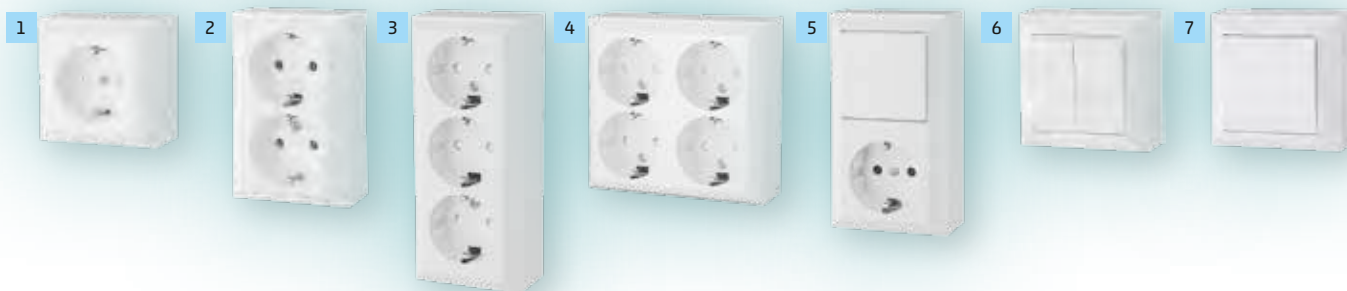

pic.	type	denomination, features
1	0310H	1 seat grounded socket, for indoor use, 230 V~ / 50 Hz / 16 A
2	0311H	2 seat grounded socket, for indoor use, 230 V~ / 50 Hz / 16 A
3	0312H	3 seat grounded socket, for indoor use, 230 V~ / 50 Hz / 16 A
4	0313H	4 seat grounded socket, for indoor use, 230 V~ / 50 Hz / 16 A

pic.	type	denomination, features
5	0314H	Socket and changeover switch combination, for indoor use, 230 V~ / 50 Hz / 16/10 A
6	0315H	Chandelier switch, for indoor use, 230 V~ / 50 Hz / 10 A
7	0316H	Changeover switch, for indoor use, 230 V~ / 50 Hz / 10 A
7	0323H	Push switch, for indoor use, 230 V~ / 50 Hz / 10 A

Recessed indoor switch family

WAVE IP20



pic.	type	denomination, features
1	3274H	WAVE 2 seat grounded socket with child protection, recessed indoor design, with frame, 230 V~ / 50 Hz / 16 A
2	3275H	WAVE grounded socket with child protection, recessed indoor design, with frame, 230 V~ / 50 Hz / 16 A
3	3276H	WAVE chandelier switch, recessed indoor design, with frame, 230 V~ / 50 Hz / 10 A
4	3277H	WAVE changeover switch, recessed indoor design, with frame, 230 V~ / 50 Hz / 10 A

Electrical equipments



pic.	type	denomination	colour	design
1	0708S	E27 socket	black	60 W
2	0716S	E27 socket	white	60 W
3	0534S	Inter-cord 1-pole switch	white	2 A
4	0535S	Inter-cord 1-pole switch	black	2 A
5	5031H	1 phase reconstructed submeter 230-250 V, 10/30 A	black	not suitable for billing purposes

Junction box

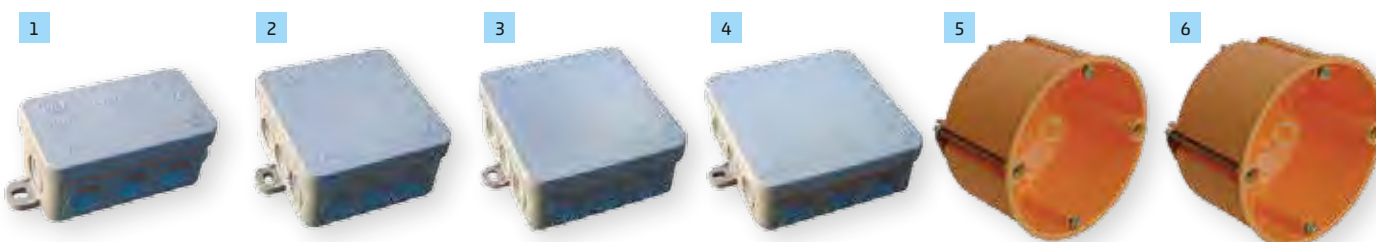

pic.	type	denomination, features
1	5229H	IP54 Junction box, 85 x 45 mm, grey, surface-mounted, water-free
2	5232H	IP54 Junction box, 75 x 75 mm, grey, surface-mounted, water-free
3	5221H	IP54 Junction box, 85 x 85 mm, grey, surface-mounted, water-free

pic.	type	denomination, features
4	5233H	IP54 Junction box, 100 x 100 mm, grey, surface-mounted, water-free
5	5202H	Plasterboard box, 45 mm deep, orange, recessed IP20
6	5200H	Plasterboard box, 60 mm deep, orange, recessed IP20

recessed switch family, electrical equipment

HJRF 4-25

Cable reel with 25/40/50 m cable



- H05VV-F 3G1,5 mm² cable, IP20 design
- can be used coiled:
250 V~ / max. 1000 W - coiled
- pipe-shape plug, 4 grounded socket
- restorer button to delete deployed thermal protection
- 25 m
- 250 V~ / max. 3000 W - unwound

HJRF 4-40/1,5

- 40 m
- 250 V~ / max. 3000 W - unwound

HJRF 4-50/1,5

- 50 m
- 250 V~ / max. 3000 W - unwound



With metal base!

HJRF 24-30

Cable reel with 27+3 m cable

This product is recommended to use in cases when we don't want to place the cable reel close to the device we wish to operate.

- H05VV-F 3G1,0 mm² cable, IP20 design
- 27 + 3 meter cable on the big and small rewinder reel
- can be used coiled:
250 V~ / max. 900 W - coiled
250 V~ / max. 2300 W - unwound
- pipe-shape plug and straight swinging socket
- restorer button to delete deployed thermal protection



With metal base!

HJRF 10-30/1,5

Cable reel with 30 m cable

- can be used coiled
- 4 grounded socket with lid
- restorer button to delete deployed thermal protection
- for outdoor use as well (IP44 protected)
- H07RN-F 3G1,5 mm² cable, IP44 outdoor design
- 250 V~ / max. 3000 W - unwound / max. 1000 W - coiled



Extension cord

- 250 V~ / 50 Hz / max. 10 A, 3 x 1,0 mm²
- 250 V~ / 50 Hz / max. 16 A, 3 x 1,5 mm²



1



2



picture	type	wire	length of the cable	colour
1	NV 3-5/WH	3 x 1,0 mm ² H05VV-F	5 m	white
2	NV 3-10/OR	3 x 1,0 mm ² H05VV-F	10 m	orange
1	NV 3-10/WH	3 x 1,0 mm ² H05VV-F	10 m	white
2	NV 3-20/OR	3 x 1,0 mm ² H05VV-F	20 m	orange
2	NV 3-30/OR	3 x 1,0 mm ² H05VV-F	30 m	orange
2	NV 3-20/OR/1,5	3 x 1,5 mm ² H05VV-F	20 m	orange
2	NV 3-30/OR/1,5	3 x 1,5 mm ² H05VV-F	30 m	orange

Cannot be used in Hungary!

NVTF 04K/WH

Power distributor with switch



- H05VV-F 3G1,5 mm² cable, IP20 design
- suitable to protect household appliances
- surge protection up to 4500 A
- fitted with child protection
- switch
- 250 V~ / 50 Hz / 16 A / 3500 W
- 4 sockets
- 1,5 m cable



PNVF 04K/WH

Power distributor with switch



- H05VV-F 3G1,0 mm² cable, IP20 design
- 250 V~ / 16 A / 3500 W
- 4 sockets
- 2 m cable
- frame can be hung on the wall



NVTF 06K/WH

- 6 sockets
- 1,5 m cable

PNVF 04K-5/WH

- 4 sockets
- 5 m cable
- frame can be hung on the wall

Power distributor

- 1 NPE 230 V~ / 50 Hz
- 250 V~ / max. 10 A, 3 x 1,0 mm², H05VV-F
- 250 V~ / max. 16 A, 3 x 1,5 mm², H05VV-F

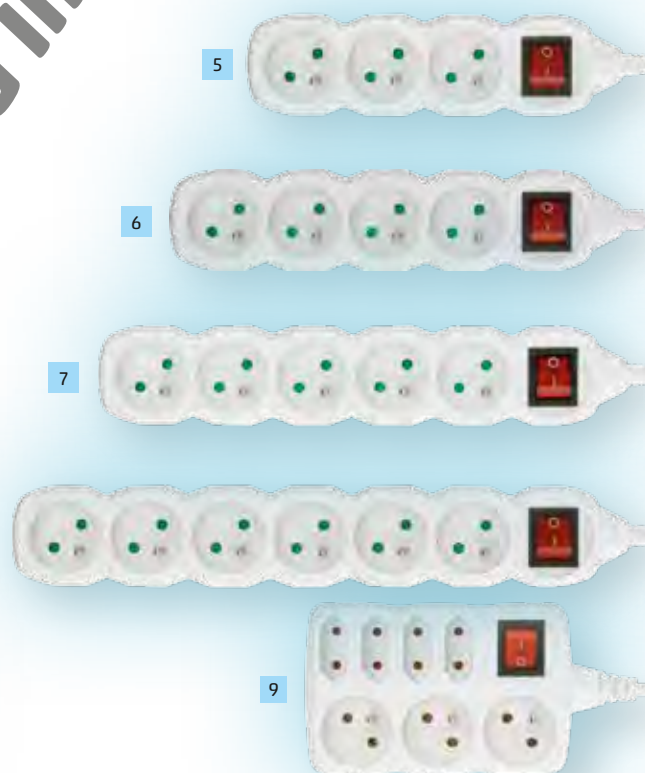
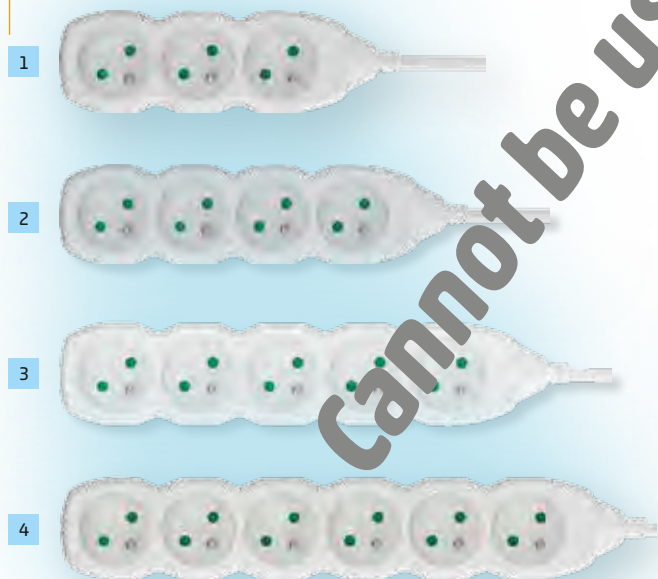

picture	type	number of sockets/cable	length of the cable	colour
1	NVF 03/WH	3/3 x 1,0 mm ²	1,5 m	white
1	NVF 03-3/WH	3/3 x 1,0 mm ²	3 m	white
1	NVF 03-5/WH	3/3 x 1,0 mm ²	5 m	white
2	NVF 04/WH	4/3 x 1,0 mm ²	1,5 m	white
2	NVF 04-3/WH	4/3 x 1,0 mm ²	3 m	white
3	NVF 05/WH	5/3 x 1,0 mm ²	1,5 m	white
3	NVF 05-3/WH	5/3 x 1,0 mm ²	3 m	white
4	NVF 06/WH	6/3 x 1,0 mm ²	1,5 m	white
4	NVF 06-3/WH	6/3 x 1,0 mm ²	3 m	white
4	NVF 06-5/W	6/3 x 1,0 mm ²	5 m	white

picture	type	number of sockets/cable	length of the cable	colour
5	NVF 03K/WH	3/3 x 1,0 mm ²	1,5 m	white
5	NVF 03K-3/WH	3/3 x 1,0 mm ²	3 m	white
5	NVF 03K-5/WH	3/3 x 1,0 mm ²	5 m	white
6	NVF 04K/WH	4/3 x 1,0 mm ²	1,5 m	white
6	NVF 04K-3/WH	4/3 x 1,0 mm ²	3 m	white
7	NVF 05K/WH	5/3 x 1,0 mm ²	1,5 m	white
7	NVF 05K-3/WH	5/3 x 1,0 mm ²	3 m	white
8	NVF 06K/WH	6/3 x 1,0 mm ²	1,5 m	white
8	NVF 06K-3/WH	6/3 x 1,0 mm ²	3 m	white
8	NVF 06K-5/WH	6/3 x 1,0 mm ²	5 m	white
9	NVF 17/WH	3 x grounded socket, 4 x euro socket, 3 x 1 mm ²	1,5 m	white

Cannot be used in Hungary!

products with French connector

Power distributor, mountable

- 250 V~ / 16 A / 3500 W
- grounded sockets
- the power strings without switch can be hung on the wall
- only can be connected with 3 x 1,5 mm² power cable
- connection can only be carried out by a professional!

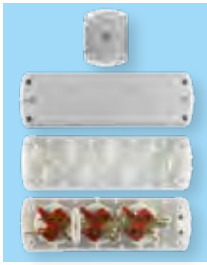

pic.	type	number of sockets	colour
1	NVF 03	3	white
2	NVF 04	4	white
3	NVF 05	5	white
4	NVF 06	6	white
5	NVF 03K	3	white
6	NVF 06K	6	white

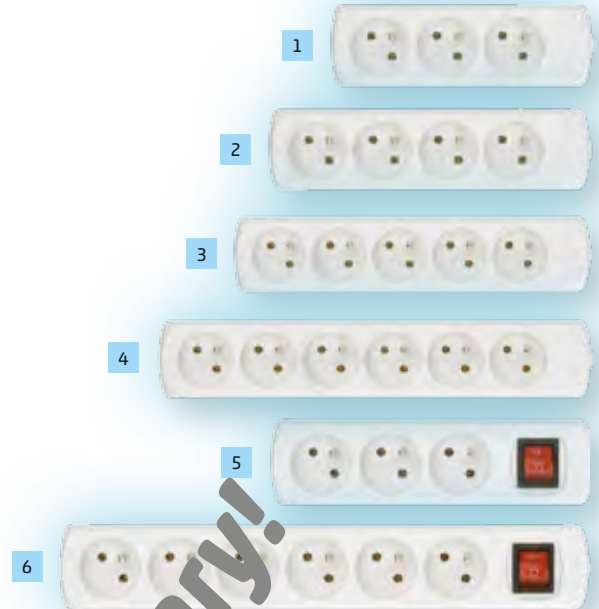

NV FP 2

Grounded plug, extra flat

- 250 V~ / max. 16 A / max. 3500 W



DOF-16

Mountable swinging plug

- 16 A / 250 V~ / 3500 W
- cable outlet on the top



NVF 16/WH

Power distributor, T-shape

- 3 grounded socket, french
- 1 NPE 250 V~, max. 16 A



NVF 2-16/WH

Power distributor, T-shape

- 3 sockets (2 grounded+ 1 euro), french
- 1 NPE 250 V~, max. 16 A



7320

Power distributor, triangular, 3 grounded sockets, french

- 3 x 16 A
- size: 90 x 85 x 75 mm



NVF 22-90

Power distributor

- 2 grounded French sockets
- 250 V~ / max. 10 A / max. 2300 W



Cannot be used in Hungary!

products with French connector

NVKF 1/WH

Network connection socket, with switch



- allows turning electric devices on and off safely
- rimmed design for ease of use
- with child protection
- switch
- for indoor use (IP20)
- 250 V ~ / 50 Hz / 16 A / 3500 W
- size: 53 x 74 x 79 mm



NVKF 3/WH

Network connection socket, with switch



- allows turning electric devices on and off safely
- 2 pcs of euro + 1 pc of grounded socket, french
- 3 socket fitted with child protection
- switch
- for indoor use (IP20)
- 250 V ~ / 50 Hz / 16 A / 3500 W

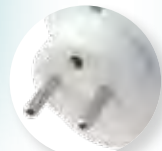

NVTF 1/WH

Network connection socket, with surge protection



- suitable to protect household appliances
- surge protection up to 4500 A
- with child protection
- for indoor use (IP20)
- 250 V ~ / 50 Hz / 16 A / 3500 W
- size: 53 x 74 x 79 mm



7300

Mechanic timer, with French connector

- min. setting time: 30 minutes
- can be switched max. 96 times a day
- manual on/off switch
- child protection lock
- 16 A / 230 V ~ / 3680 W
- size: 103 x 54 x 70 mm



7301

Digital indoor weekly timer, with French connector

- max. 140 programmes/week
- countdown and random switch-on function
- daylight saving time
- 12/24 hour display
- built-in accumulator
- child protection lock
- 16 A / 230 V / 2000 W
- size: 54 x 102 x 76 mm



7302

Mechanic outdoor timer, 24h/15min, with French connector

- min. setting time: 15 minutes
- can be switched max. 96 times a day
- operating temperature: between -25 °C and 55 °C
- child protection lock
- 16 A / 230 V / 3680 W
- IP44
- size: 141 x 80 x 79 mm



7303

Mechanic indoor timer, 24h/15min, with French connector

- min. setting time: 15 minutes
- can be switched max. 96 times a day
- manual on/off switch
- child protection lock
- 16 A / 230 V / 3680 W
- size: 82,5 x 81 x 78 mm



7304

Digital indoor daily timer, with French connector

- large LCD display
- 24 turn on and off/day
- manual on/off switch
- built-in accumulator
- child protection lock
- 16 A / 230 V / 200 W
- size: 126 x 56 x 76 mm



products with French connector



In order to preserve our health, prevention is very important. In favor of this often voiced view it is time to act, related to this, we offer our health care products. With the help of our activity monitoring fitness watch you can discover your daily activity, analyze your sleep and with that in your mind you can change your lifestyle. If you get sick, it is essential to have a fast and reliable thermometer, especially when it comes to a child.

Health care

FW 360/BL

Fitness watch

- blue



- 8in1 multifunction watch
- time and date / odometer / telemeter / calorie counter / monitoring the daily goal / alarm clock/ sleep analyzer / phone alert
- no button, features are switchable by tapping
- energy saving OLED display, 0.68"
- energy saving BT 4.0 connection
- long operating time; 12-14 hours a day with one charge
- built-in Li-Po accumulator (3,7 V / 60 mAh)
- accessory microUSB charging cable
- can be used up to 70 mm wrist
- 40 x 250 x 16 mm / 19 g

- 1 12-01 12:56 :01
- 2 01234
- 3 12.34
- 4 01234
- 5 26%
- 6 12:34
- 7 sleep
- 8 12:34



FW 360/BK

- black

FW 360/WH

- white

FW 360/PI

- pink



Android 4.3 or later version
iPhone 4S
+ iOS 7.0 or later version



SKL 610 Salt crystal lamp

- wooden base with E14 socket, 1,5 m cord with switch, 15 W bulb (included)
- power supply: 230 V~/50 Hz
- weight: 6-10 kg

WS 2300

- weight: 2-3 kg

SKL 12

- weight: 1-2 kg



SKM 57 Salt crystal tea light holder

- hollowed tea light holder
- weight: 0,5 - 0,7 kg



94807 Digital breathalyser

- fast reaction, warm-up time 10 sec., answer <5 sec.
- warning with sound
- value range: 0.00-0.19% BAC
- measurement accuracy: 0,01% BAC
- LCD display, turns off automatically
- power supply: 2 x 1,5 (AAA) batteries, not included
- size: 95 x 36 x 18 mm



IR 110 Infra lamp

- beneficial effects to the body
- adjustable in 4 positions, 0 - 60° degrees
- heatproof plastic housing
- 1,5 m power cable
- output: 100 W
- power supply: 230 V~/ 50 Hz
- size: 180 x 180 x 18 mm



PHT 01 pH tester & thermometer



- Acidic or alkaline? Read it immediately!
- pH 0,00 - 14,00 / 0 - 60 °C
 - measurement of the temperature of the fluids and air
 - applicable areas: health care, nutrition, hobby, work
 - ideal for: swimming pool, whirlpool, aquarium, pond, tap water, mineral water, juices, wine, coffee, tea, body fluid, irrigation water...
 - clearly visible 4 digit LCD display
 - modern, glass electrode probe
 - automatic temperature compensation
 - single-point calibration opportunity
 - accessory calibrating screwdriver and protective case
 - power supply: 2 x LR44 (1,5 V) (included)
 - size: 155 x 29 x 16 mm



LMF 001 Digital thermometer with flexible shaft

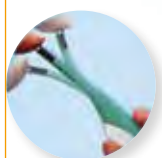

- LCD display
- flexible shaft
- memorises the last data
- cca. 100 hour operating time with one battery
- power supply: 1 x AG3 (1,5 V) button battery (included)
- size: 125 x 18 x 10 mm



LM 001 Digital thermometer



- LCD display
- memorises the last data
- cca. 100 hour operating time with one battery
- power supply: 1 x AG3 (1,5 V) button battery (included)
- size: 143 x 22 x 10 mm

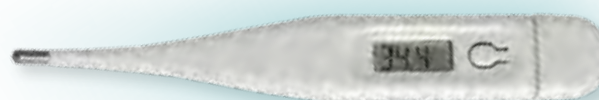

thermometer, infra lamp, breathalyser, pH tester, salt crystal lamp and tea light holder



The investigation of a wide variety of electrical and other properties in a professional manner, ranging from simple, multifunctional voltage tester, to digital, computer-connected quality laboratory instruments. Special purpose-designed instruments and accessories to be used on purpose can be found in our range.

Measuring technology

MS 8209

Professional multimeter

**-20 °C
-1000 °C**

- 5in1 instrument
- extra function: temperature, humidity, brightness, SPL
- accessories: measuring cord, temperature measurer probe, 9V battery

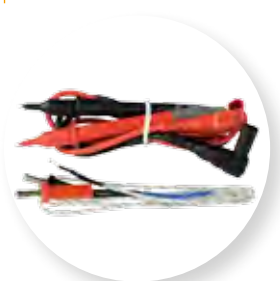

MS 8250B

Digital multimeter



- can be connected to computer
- following operation systems are compatible with this instrument: Windows 2000, XP, Server 2003, Vista 7, 8, 8.1 and 10
- accessories: measuring cord, USB connector, software/driver CD, 9 V (6F22) battery



SMA 68

Digital multimeter



- automatic changing in measuring limits
- contactless phase searching
- accessories: measuring cord, transistor tester socket, 9 V battery



SMA 64

Digital multimeter



- accessories: measuring cord, transistor tester socket, 9 V battery



MY 64

Professional multimeter



- automatic changing in measuring limits
- accessories: measuring cord, temperature measurer probe, 9 V battery



	MS 8250B	MS 8209	SMA 68	SMA 64	MY 64
DC voltage	400 mV / 4 V / 40 V / 400 V / 600 V	400 mV / 4 V / 40 V / 400 V / 600 V	400 mV / 4 V / 40 V / 400 V / 1000 V	200 mV / 2 V / 20 V / 200 V / 1000 V	200 mV / 2 V / 20 V / 200 V / 1000 V
AC voltage	400 mV / 4 V / 40 V / 400 V / 600 V	4 V / 40 V / 400 V / 600 V	400 mV / 4 V / 40 V / 400 V / 750 V	2 V / 20 V / 200 V / 750 V	2 V / 20 V / 200 V / 700 V
DC (direct current)	400 µA / 4 mA / 40 mA / 400 mA / 4 A / 10 A	40 mA / 400 mA / 10 A	400 µA / 4 mA / 40 mA / 400 mA / 4 A / 10 A	2 mA / 20 mA / 200 mA / 10 A	2 mA / 20 mA / 200 mA / 10 A
AC (alternate current)	400 µA / 4 mA / 40 mA / 400 mA / 4 A / 10 A	40 mA / 400 mA / 10 A	400 µA / 4 mA / 40 mA / 400 mA / 4 A / 10 A	20 mA / 200 mA / 10 A	20 mA / 200 mA / 10 A
resistance	400 Ω / 4 kΩ / 40 kΩ / 400 kΩ / 4 MΩ / 40 MΩ	400 Ω / 4 kΩ / 40 kΩ / 400 kΩ / 4 MΩ / 40 MΩ	400 Ω / 4 kΩ / 40 kΩ / 400 kΩ / 4 MΩ / 40 MΩ	200 Ω / 2 kΩ / 20 kΩ / 200 kΩ / 2 MΩ / 20 MΩ / 200 MΩ	200 Ω / 2 kΩ / 20 kΩ / 200 kΩ / 2 MΩ / 20 MΩ / 200 MΩ
capacity	40 nF / 400 nF / 4 µF / 40 µF / 100 µF	4 nF / 40 nF / 400 nF / 4 µF / 40 µF / 200 µF	4 nF / 40 nF / 400 nF / 4 µF / 40 µF / 200 µF	2 nF / 20 nF / 200 nF / 2 µF / 200 µF	2 nF / 20 nF / 200 nF / 2 µF / 20 µF
frequency	5 Hz / 50 Hz / 500 Hz / 5 KHz / 50 KHz / 500 KHz / 5 MHz	9,999 Hz / 99,99 Hz / 999,9 Hz / 9,999 KHz / 99,99 KHz / 199,9 KHz	9,999 Hz / 99,99 Hz / 999,9 Hz / 9,999 KHz / 99,99 KHz / 999,9 KHz / 9,999 MHz	20 KHz	20 KHz
duty cycle	10 - 95 %	0 - 100 %	0 - 100 %	-	-
temperature	-	-20 °C - 1000 °C	-	-20 °C - 1000 °C	-20 °C - 1000 °C
humidity	-	30 - 90 %	-	-	-
SPL	-	35 - 100 dB	-	-	-
brightness	-	4000 Lux / 40000 Lux	-	-	-
display counter	3999	4000	4000	1999	1999
USB connection	+	-	-	-	-
contactless phase searching	+	-	+	-	-
diode test	+	+	+	+	+
tear test	+	+	+	+	+
transistor measuring	+	-	+	+	+
relative measuring	+	+	+	-	-
automatic changing in measuring limits	+	+	+	-	-
manual change in measuring limits	+	+	+	+	+
recording maximum/minimum values	+	-	-	-	-
recording measured values	+	+	+	+	-
automatic switch off	+	+	+	+	-
backlight	+	+	+	-	-
power supply	9 V (6F22)	9 V (6F22)	9 V (6F22)	9 V (6F22)	9 V (6F22)
measuring categories	CAT IV 600 V	CAT III 600 V	CAT III 1000 V, CAT IV 600 V	CAT III 1000V, CAT IV 600 V	CAT II 1000 V, CAT III 600 V
size	180 mm x 86 mm x 52 mm	158 mm x 78 mm x 39 mm	195 mm x 92 mm x 55 mm	195 mm x 92 mm x 55 mm	200 mm x 98 mm x 55 mm

SMA 92 Digital multimeter

20 KHz

- automatic changing in measuring limits
- backlight
- accessories: measuring cord, 9V battery



SMA 830 Digital multimeter

- accessories: measuring cord, 9V battery



MAS 830 Digital multimeter

- recording measured values
- accessories: measuring cord, 9V battery



VC 830L Digital multimeter

- backlight
- recording measured values
- accessories: measuring cord, 9V (6F22) battery



multimeter

	SMA 92	SMA 830	MAS 830	VC 830L
DC voltage	200 mV / 2V / 20V / 200V / 600V	200 mV / 2V / 20V / 200V / 600V	200 mV / 2V / 20V / 200V / 600V	200 mV / 2V / 20V / 200V / 600V
AC voltage	2V / 20V / 200V / 600V	200V / 600V	200V / 600V	200V / 600V
DC (direct current)	200 µA / 2 mA / 20 mA / 200 mA / 10 A	20 µA / 200 µA / 2 mA / 20 mA / 200 mA / 10 A	20 µA / 200 µA / 2 mA / 20 mA / 200 mA / 10 A	20 µA / 200 µA / 2 mA / 20 mA / 200 mA / 10 A
AC (alternate current)	200 µA / 2 mA / 20 mA / 200 mA / 10 A	-	-	-
resistance	200 Ω / 2 kΩ / 20 kΩ / 200 kΩ / 2 MΩ / 20 MΩ	200 Ω / 2 kΩ / 20 kΩ / 200 kΩ / 2 MΩ	200 Ω / 2 kΩ / 20 kΩ / 200 kΩ / 2 MΩ	200 Ω / 2 kΩ / 20 kΩ / 200 kΩ / 2 MΩ
capacity	-	-	-	-
frequency	20 KHz	-	-	-
duty cycle	-	-	-	-
temperature	-	-	-	-
humidity	-	-	-	-
SPL	-	-	-	-
brightness	-	-	-	-
display counter	1999	1999	1999	1999
USB connection	-	-	-	-
contactless phase searching	-	-	-	-
diode test	+	+	+	+
tear test	+	+	+	+
transistor measuring	-	-	-	-
relative measuring	-	-	-	-
automatic changing in measuring limits	+	-	-	-
manual change in measuring limits	-	-	-	-
recording maximum/minimum values	+	-	-	-
recording measured values	+	+	+	+
automatic switch off	+	-	-	-
backlight	+	-	-	+
power supply	9 V (6F22)	9 V (6F22)	9 V (6F22)	9 V (6F22)
measuring categories	CAT III 600 V	CAT III 600 V	CAT II 600 V	CAT II 600 V
size	140 mm x 67 mm x 30 mm	138 mm x 69 mm x 31 mm	138 mm x 69 mm x 31 mm	140 mm x 73 mm x 30 mm



DM 4070 Digital LCR meter

- accessories: measuring cord with clips (10 cm), 9 V (6F22) battery



SMA 2101 AC/DC clamp meter

- accessories: measuring cord, protective case, 3 x 1,5 V batteries

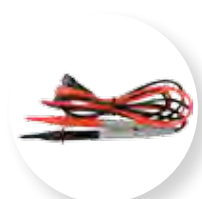

M 266 AC clamp meter

- accessories: measuring cord, protective case, 9 V batteries

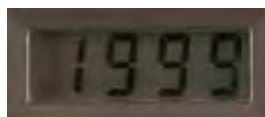

	DM 4070	SMA 2101	M 266
DC voltage		400 mV / 4 V / 40 V / 400 V / 600 V	1000 V
AC voltage		4 V / 40 V / 400 V / 600 V	750 V
DC (direct current)		40 A / 400 A	
AC (alternate current)		40 A / 400 A	200 A / 1000 A
resistance	20 Ω / 200 Ω / 2 KΩ / 20 KΩ / 200 KΩ / 20 MΩ	400 Ω / 4 KΩ / 40 KΩ / 400 KΩ / 4 MΩ / 40 MΩ	200 Ω / 20 KΩ
capacity	200 pF / 2 nF / 20 nF / 200 nF / 2 μF / 20 μF / 200 μF / 2 mF	40 nF / 400 nF / 4 μF / 40 μF / 400 μF / 4000 μF	
frequency		9,999 Hz / 99,99 Hz / 999,9 Hz / 9,999 KHz / 99,99 KHz / 999,9 KHz / 9,999 MHz	
inductance	200 μH / 2 mH / 20 mH / 200 mH / 2 H / 20 H		
duty cycle		0 - 100 %	
absolute dB			
battery test			
display			
display counter	1999	4000	1999
diode test		+	
tear test		+	+
relative measuring		+	
automatic changing in measuring limits		+	
manual change in measuring limits		+	
recording maximum/minimum values		+	
recording measured values		+	+
automatic switch off	+	+	
backlight		+	
power supply	9 V (6F22)	3 x 1,5 V (AAA)	9 V (6F22)
measuring categories	CAT II	CAT III 600 V	CAT II 1000 V, CAT III 600 V
size	185 mm x 93 mm x 35 mm	208 mm x 78 mm x 35 mm	96 mm x 235 mm x 46 mm

MVT 808ACE

Bipolar AC/DC voltage tester



- for 6-400 V AC and DC voltage
- 10 LED indicators
- simple use
- robust housing and cord
- equipped with switch to perform measures under 24 V
- length of connection cable: 0,6 m
- length of housing: 220 mm



NT-305

Voltage tester



Pro'sKit®

- blue LED backlight
- checking the presence of AC voltage and DC voltage
- AC voltage test: 70 - 250 V~
- DC voltage test: mmax. 12, 36, 55 V ---
- circuit continuity -test
- automatic sensing function by testing battery voltage
- power supply: 1xCR927 (3V) battery, included
- size: 140 x 25 x 15 mm



VD 22

Voltage tester



- checking the presence of alternate voltage
- safe: contactless sensing (90-1000 V~)
- ideal for troubleshooting: for extension cords, power distributors, wall outlets, light strips, lamps, cables, inside appliances or switchboards...
- warns immediately remarkably and well sensibly
- intermittent beep and a flashing red light
- separately switchable LED lamp
- battery life-span: ca. 1,5 year standby, 6 hours use
- power supply: 2 x AAA (1,5V) battery, not included
- size: 150 x 16 x 20 mm

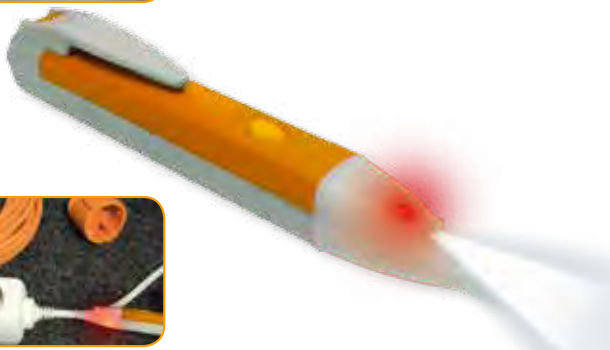

FC 20

Voltage tester

- phase searching with metal connection
- optical signal in case of phase result
- 190 mm total length

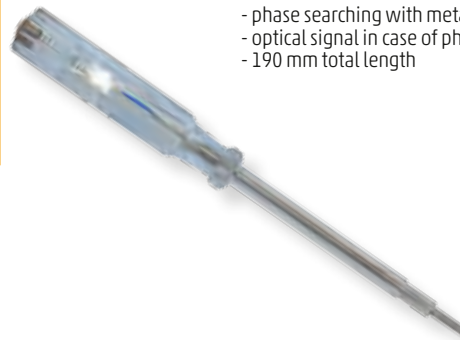

FC 10

Voltage tester

- phase searching with metal connection
- optical signal in case of phase result
- practical hanging hook
- 140 mm total length

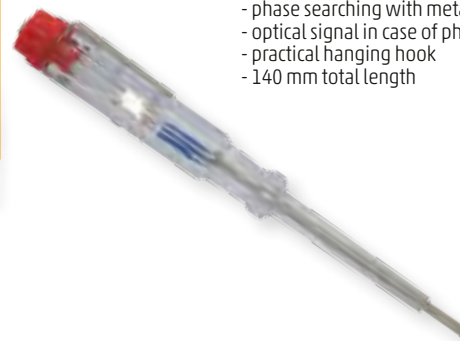

MZ 3

Measuring cord



- measuring category: CAT III 1000 V; CAT IV 600 V - 10 A
- 1 m



MZ 2

Measuring cord

- measuring category: CAT I 1000 V; CAT II 600 V
- 10 A
- 0,9 m



ET 3

Battery tester

- for testing button cells, batteries, 9V batteries
- 1,5 V / 9 V max. (AG, AAA, AA, C, D, 6LR61)
- easy, quick handling
- stress testing
- size: 110 x 60 x 25 mm



S 98G

Measuring tape with bubble level



- 20 cm ruler with magnetic base
- built-in 1 m metal measuring tape
- 1 fixed and 1 rotatable bubble level with protractor and locking latch
- ABS house



MTP 10-25

Measuring tape

- length: 10 m
- width: 25 mm

- meter/foot scale
- rubber coated housing
- blocking function
- metal tape with hook on the end



MTP 5-25

- length: 5 m
- width: 25 mm

MTP 3-12,5

- length: 3 m
- width: 12,5 mm

BD 5G/BK

Banana plug

- black



- plastic
- cross-hole type
- screwable
- gold plated



BD 5G/RD

- red

BD 4/BK

Banana plug

- black

- plastic
- cross-hole type
- screwable



BD 4/RD

- red

BA 2/BK

Banana socket

- black

- plastic
- insulated
- solderable



BA 2/RD

- red

BA 1/BK

Banana socket

- black

- plastic
- solderable



BA 1/RD

- red

Entry-level and professional soldering irons, glue guns and soldering stations, as well as the corresponding useful accessories for fast, accurate, high-quality work. Soldering irons with different performance and designs enable work with different soldering materials of different weights and ensure reliable soldering.



Soldering technology



SMA 051 Soldering station



- with LED display
- 230 V~/48 W
- fast heat up
- adjustable and controllable temperature (150 - 420 °C)
- 3-digit red LED display
- heat resistant silicone cable
- silicone rubber on the grip
- replaceable soldering iron: SMA 5051T
- it can be replaced without tool
- cleaning sponge and tray
- adjustable soldering iron holder

SMA 050

Soldering station



- 230 V~/ 48 W
- fast heat up
- adjustable temperature (150 - 420 °C)
- heat resistant silicone cable
- silicone rubber on the grip
- replaceable soldering iron: SMA 5051T
- it can be replaced without tool
- cleaning sponge and tray
- adjustable soldering iron holder



SMA 5051T

Replaceable soldering iron



- for SMA 051 and SMA 050 soldering stations
- it can be replaced without tool
- silicone protective sheath on the grip
- 24 V~/ 48 W
- length of cable: 1,05 m



SMA 055

Soldering pin

0,8 mm, point head

- for SMA 051 and SMA 050 soldering stations



SMA 056

0,4 mm, point head

SMA 057

3,2 mm, flat head

SMA 059

1,2 mm, point head

SMA 058

1,2 mm, flat head

FP 80/VDE

Soldering iron

- 230V~/ 80 W
- length of soldering iron: 290 mm
- length of power cable: 1,4 m

**230 V~
80 W**

- accessory desk stand, good quality connection cable with strain relief



FP 1230/VDE

Soldering iron

**12 V~
30 W**

- 12 V~/ 30 W
- connection cable with strain relief
- with car cigarette lighter plug
- length of soldering iron: 220 mm
- length of power cable: 1,3 m



FP 30/VDE

- 230V~/ 30 W
- length of soldering iron: 240 mm
- length of power cable: 1,4 m

**230 V~
30 W**

FP 60/VDE

- 230V~/ 60 W
- length of soldering iron: 270 mm
- length of power cable: 1,4 m

**230 V~
60 W**

FPH SERIES

Straight pin for soldering irons

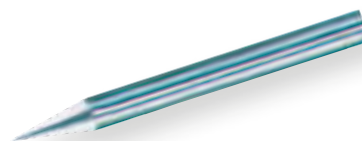

FPH 4

- for FP 30/VDE 30 W soldering irons
- diameter: 4 mm

FPH 6

- for FP 60/VDE 60 W soldering irons
- diameter: 6 mm

FPH 7

- for FP 80/VDE 80 W soldering irons
- diameter: 7 mm

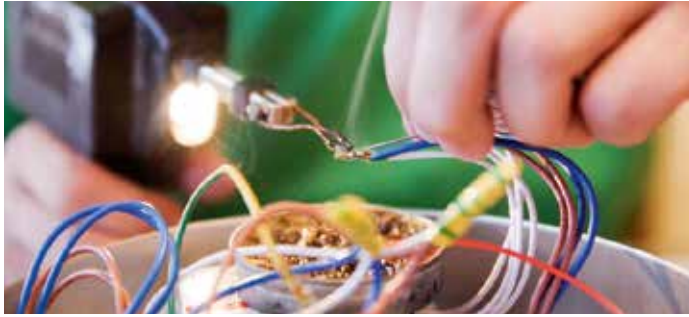

PP 1 Soldering gun



- 230 V~ / 75 W
- built in lighting: bulb: 6,3 V/0,3 A/E10
- 2 m power cable
- 40 mm/1,5 mm² red copper soldering pin
- accessories: 5 + 1 pcs spare pin



PP 1T Soldering pin for PP 1 soldering gun

- 40 mm/1,5 mm² red copper
- 10 pcs/package



8PK-366N-G Desoldering pump



Pro'sKit®

- large suction capacity
- durable heat resistant, stabile Teflon tip, which is built into its slot
- double rubber ring
- removable coloured covering
- size: Ø26 x 205 mm



5PK-366N-T

- Spare tip for desoldering pump
- for 8PK-366N-G type
 - stabile Teflon tip, built into its slot
 - black tip, grey house, with sealing ring



SG 109 Soldering gun

- 100 W / 230 V~ / 50 Hz
- fast heat up
- built in bulb
- pin is replaceable without tool



SG 109T

Spare pin

- SG 109 for soldering gun

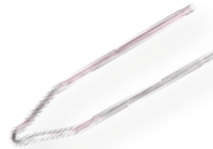

8PK-101-2 Gas soldering tool



Pro'sKit®

- for soldering, heating, shrinking, tinning, cutting
- adjustable piercing flame
- accessory: 2 pcs head
- can be filled with cigarette lighter gas
- length of tool: 130 mm
- delivered without gas



5PK-101-2T

Spare tip for gas soldering tool

- for 8PK-101-2 gas soldering tool



HSP 75 Desoldering pump



- large suction capacity, easy, easy to clean
- metal housing
- size: Ø20 x 190 mm



HSP 75T

Spare tip for desoldering pump

- for HSP 75 type



SW SERIES

Soldering tin



High quality soldering tin from European manufacturer!
Composition: SN / PB: 60/40%, resin: 2.0%



type	size	packing unit
SW 0,5/250	Ø0,5 mm	250 g
SW 0,8/100	Ø0,8 mm	100 g
SW 0,8/250	Ø0,8 mm	250 g
SW 0,8/500	Ø0,8 mm	500 g
SW 1/100	Ø1,0 mm	100 g
SW 1/250	Ø1,0 mm	250 g
SW 1/500	Ø1,0 mm	500 g

type	size	packing unit
SW 1,5/250	Ø1,5 mm	250 g
SW 1,5/500	Ø1,5 mm	500 g
SW 2/100	Ø2,0 mm	100 g
SW 2/250	Ø2,0 mm	250 g
SW 2/500	Ø2,0 mm	500 g
SW 3/250	Ø3,0 mm	250 g

SWCU 1/17

Soldering tin-pen



Soldering tin in pen-looking dispenser house.
Tin can be portioned quickly to the place of soldering.

Features of the tin:

- diameter: 1 mm
- SW/CU: 99,5/0,5 %
- resin: 2,2 %
- net weight: 17 g
- size: Ø17 x 91 mm
- Unleaded!



soldering tin, excipient

TS 500

Soldering resin - 50 g

Fluxing resin containing a softening agent, for delicate electronics soldering work. Acid-free, it does not cause corrosion when it stays on the surface.



TS 560

Soldering oil - 20 ml

Slightly activated chlorine-free flux for delicate electronic soldering works.



TS 570

Soldering cream - 50 cm³

Acid-free, strong cleaning soft soldering flux. Useable for soft soldering of copper, tin, steel and acid-proof steel.

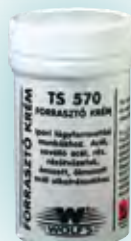

TS 580

Thermally conductive paste - 25 g



Electrically insulating, heat resistant up to 200 °C, non-resinous, conduction ability: 0,24-0,42 W/mK heat transferring paste.



SMA 008

Glue gun with switch

230 V~
100 W

- 230 V~ / 50 Hz / 100 W
- safe PTC heating element
- with on/off switch
- heating indicator light
- for Ø11 mm glue rods (e.g.: SMA 067T)
- length of power cable: 1,4 m



SMA 007

Glue gun

230 V~
100 W

- 25 (100) W / 230 V~ / 50 Hz
- fast, punctual sticking
- 1 minute drying time
- tiltable desktop support
- 2 pcs free glue rods
- recommended glue rod: SMA 067T



GK-380B

Glue gun



230 V~
80 W

- 15 (80) W / 230 V~ / 50 Hz
- fast, punctual sticking
- tiltable desktop support
- recommended glue rod: SMA 067T

Pro'sKit®



SMA 006

Glue gun

230 V~
60 W

- 18 (60) W / 230 V~ / 50 Hz
- fast, punctual sticking
- 1 minute drying time
- tiltable desktop support
- 2 pcs free glue rods
- recommended glue rod: SMA 067T



SMA 005

Glue gun

230 V~
30 W

- mini
- 10 (30) W / 230 V~ / 50 Hz
- fast, punctual sticking
- 1 minute drying time
- tiltable desktop support
- 2 pcs free glue rods
- recommended glue rod: SMA 005T



SMA 009

Glue gun with switch

230 V~
20 W

- 230 V~ / 50 Hz / 20 W
- safe PTC heating element
- with on/off switch
- heating indicator light
- for Ø7 mm glue rods (eg. SMA 005T)
- length of power cable: 1,4 m

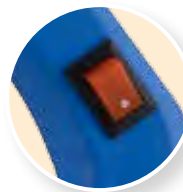

SMA 067T

Glue rod

- Ø11 mm x 100 mm
- 10 pcs x 11 g
- for GK-380B, SMA 008, SMA 007 and SMA 006 glue guns

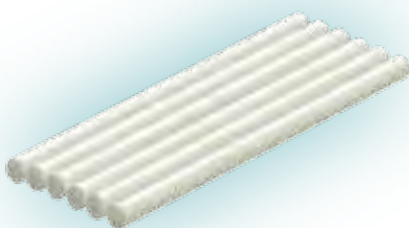

SMA 005T

Glue rod

- Ø7 mm x 100 mm
- 20 pcs x 4,5 g
- for SMA 009 and SMA 005 glue guns

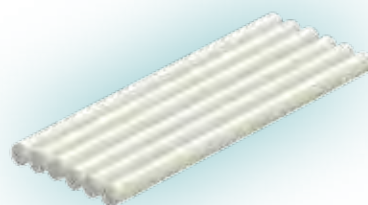

Tools

Wide range of tools can be used at home and in professional workshops from the simplest screwdrivers via the multifunction pliers to universal tool sets.

If you need to mark, cut, screw, squeeze, tighten, hold, shape, press, strip some mini or bigger workpieces, then you can find here the best tools.



SZK 30

Cutter

- massive plastic house with rubber coated grip
- metal blade lead
- automatic blade fixing and change
- spare blade holder inside the housing of the cutter
- accessory: 5 pcs 18 mm blade



SZKS 01

Cutter set, 3 pcs

3in1

- 1 pc narrow cutter, with 9 mm blade
- 1 pc general size cutter with 18 mm blade
- 1 pc cutter with 18 mm blade in massive housing



SZK 21

Cutter

- plastic housing
- metal blade lead
- accessory: 1 pc 18 mm blade



SZK 20

Cutter

- plastic housing
- accessory: 1 pc 18 mm blade

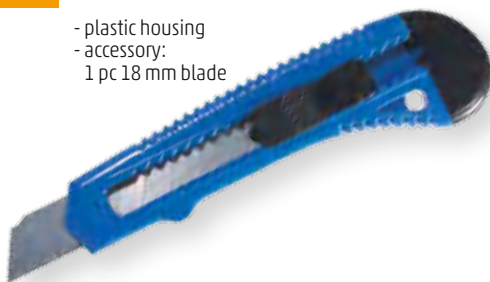

SZK 10

Cutter

- plastic housing
- accessory: 1 pc 9 mm blade



SZKB 2

Spare blade

- for SZK 20 and SZK 21 cutters
- 18 mm
- 12 pcs/package

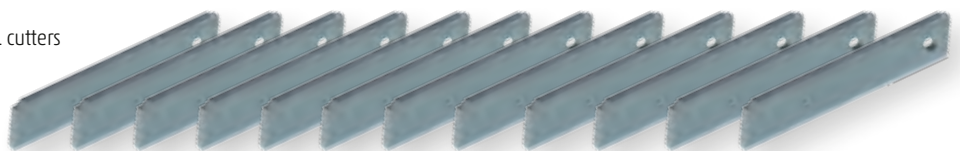

KOF 7

Combination pliers

- 180 mm

- made from steel
- insulated grip

KOF 6

- 160 mm



OLOF 7

Cutting nippers

- 180 mm

- made from steel
- insulated grip

OLOF 6

- 160 mm

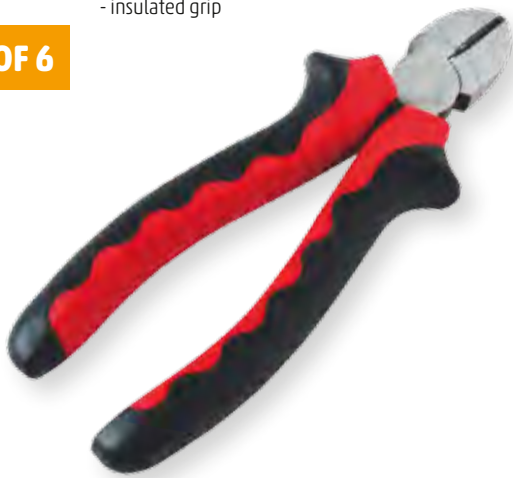

KROF 8

Crocodile plier

- 200 mm

- made from steel
- insulated grip

KROF 6

- 160 mm



1PK-067AS

Side cutters



Pro'sKit®

- 165 mm
- made from steel
- induction hardened cutting edges
- for cutting and stripping
- insulated grip



1PK-052AS

Combination pliers



Pro'sKit®

- 165 mm
- made from steel
- precise plier surfaces
- induction hardened cutting edges
- for cutting, stripping, tightening screw head, bending
- insulated grip



material	cutting thickness
hard steel	1,2 mm
soft steel	2,0 mm
copper	2,6 mm



material	cutting thickness
hard steel	1,2 mm
soft steel	2,2 mm
copper	3,0 mm

1PK-037S

Diagonal cutting plier



Pro'sKit

- 110 mm
- made from steel
- hardened and tempered edges
- roughened, PVC coating on grip
- for cutting, stripping

material	cutting thickness
hard steel	0,8 mm
soft steel	1,3 mm
copper	1,6 mm

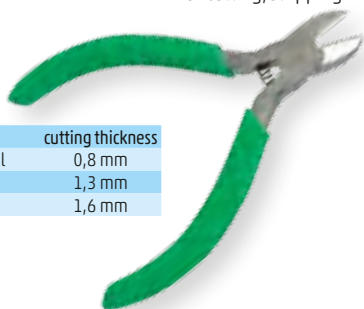

1PK-036S

Long nose plier



Pro'sKit

- 135 mm
- made from steel
- hardened and tempered edges
- roughened, PVC coating on grip
- for cutting, stripping, fastening, bending

material	cutting thickness
hard steel	0,8 mm
soft steel	1,3 mm
copper	1,6 mm



1PK-055S

Bent nose plier



Pro'sKit

- 130 mm
- made from steel
- precise design for clamping surface
- roughened, PVC coating on grip
- for fastening, bending



PA-101

Micro cutting plier

Pro'sKit

- 130 mm
- hard metal edges: 65 Mn (HRC: 52°)
- nonslip grip
- precise cutting



HT 109

Cutting plier

- 130 mm
- hard metal edges
- for cutting and stripping
- with spring mechanism



material	cutting thickness
soft steel	0,8 mm
copper	1,2 mm

CP-080E

Wire stripping tool



Pro'sKit

- 172 mm
- cable stripping: 0,2 - 6 mm²
- for cutting and stripping
- adjustable stripping length



AF 6

Wire stripping tool

- 172 mm
- cable stripping: 0,2 - 6 mm²
- for cutting and stripping
- adjustable stripping length



CP-312B

Coaxial cable stripper

Pro'sKit

- for RG-58/ 59/ 3C/ 4C cables
- minimum diameter of cables: 4 mm
- maximum diameter of cables: 10 mm
- hex key included



CP-501BN

Wire stripper tool

Pro'sKit

- for stripping round cables with 3.31 mm², 2.08 mm², 1.31 mm² cross section, with plastic insulation, as well as for stripping 8.36 mm² heavy-duty cables
- stripper for flat cables with 0.82 mm² - 0.32 mm² cross section
- adjustable knob for fitting different cable sizes



plier

AF 7

Cable stripper and crimping tool

- cutting
- cable stripping: 0,2 mm² - 6 mm²
- insulated and non-insulated terminal crimping: 0,5 - 6 mm²
- stripping force adjustment
- accessory: 270 pcs terminal, ferrules, cable tie, wire



8PK-371D

Cable stripper and crimping tool



Pro'sKit

- 210 mm
- for insulated terminals: 0,5 - 6 mm²
- for non-insulated terminals: 0,5 - 6 mm²
- cutting wires
- quick cable stripping: 0,2 mm² - 6 mm²
- fixable stripping length
- rotary and removable stopper block



6PK-230PA

Crimping tool



Pro'sKit

- 230 mm
- hexagonal crimping for coax connectors
- for 5 size of cables: 1,73/ 2,49/ 5,41/ 6,48/ 8, 15 mm
- coaxial cables: RG 55/ 58/ 59/ 5/ 6
- with ratchet gear, automatic locking
- soluble locking in case of wrong crimping
- cutting wires
- quick cable stripping: 0,2 mm² - 6 mm²
- fixable stripping length
- rotary and removable stopper block
- 6 kinds of selectable torque



6PK-230C

Crimping tool



Pro'sKit

- 220 mm
- for crimping non-insulated terminals 0,5 - 6 mm²
- ratchet gear, automatic locking
- soluble locking in case of wrong crimping
- 6 kinds of selectable torque



6PK-301H

Crimping tool



Pro'sKit

- 220 mm
- for crimping insulated terminals
- red: 0,5 - 1,0 mm²
- blue: 1,5 - 2,5 mm²
- yellow: 4 - 6 mm²
- ratchet gear, automatic locking
- soluble locking in case of wrong crimping
- 6 kinds of selectable torque



SM-336H

Crimping pliers

- 215 mm
- for insulated terminals crimping
- red: 0,5-1,0 mm²-ig
- blue: 1,5-2,5 mm²-ig
- yellow: 4-6 mm²-ig
- with ratchet gear, automatic latching
- in case of faulty crimping, latch can be released
- 6 selectable torque
- plastic grip



8PK-313B

Crimping pliers



Pro'sKit®

- 230 mm
- for crimping insulated and non-insulated terminals
- insulated:
- red: 1,5 mm²-ig,
- blue: 2,5 mm²-ig,
- yellow: 6 mm²-ig
- non-insulated:
- 1,5/2,5/- 6 mm²-ig
- cutting wires
- stripping wires:
- for 0,75 - 6 mm²
- shortening screws:
- M2,6 / M3 / M3,5 / M4 / M5



8PK-CT005

Ferrules- crimping pliers



Pro'sKit®

- 160 mm
- for crimping ferrules on the wire-ends
- for 7 kinds of size:
- 0,25/0,34/0,5/0,75/1,0/1,5/2,5 mm²
- 150 pcs ferrules as accessory:
- 40 db 0,5 x 6 mm
- 40 db 0,75 x 6 mm
- 30 db 1,0 x 6 mm
- 20 db 1,5 x 8 mm
- 20 db 2,5 x 7 mm



TW 4-6

Crimping pliers for telephone plugs



METAL

- 210 mm
- metal
- 4for 4/4, 6/6, 8/8 connectors
- two kinds of stripping length (6/12 mm)
- cutting, stripping, crimping
- release-able, automatic latching

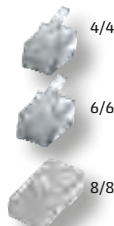

TW 3-6

Crimping pliers for telephone plugs

- 210 mm
- ABS plastic
- for 4/4, 6/6, 8/8 connectors
- two kinds of stripping length (6/12 mm)
- wide edges
- cutting, stripping, crimping

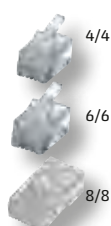

plier

8PK-8100

Insulated screwdriver set, 7 pcs



Pro'sKit®



- for max. 1000 V~ voltage
- chrome-vanadium steel
- strongly magnetized heads



⊖ flat	2,5; 4; 5,5; 6,5
⊕ Phillips	PH0, PH1, PH2

DE 305822

Screwdriver set, 18 pcs

- extremely massive rubber coated grip (except 50 mm long screwdrivers)
- swivel grip for 50 mm long screwdrivers
- wall mountable container



⊖ flat	2x50; 2,5x50; 3x50; 4x75; 6,5x38; 6,5x100; 8x150
⊕ Phillips	PH00x50, PH0x50, PH1x80, PH2x38, PH2x100, PH3x150
⊗ Torx	T6x50, T7x50, T8x50, T9x50, T10x50

DE 101505

101 pcs ratchet screwdriver set

- grip: 3/4" size, ratchet mechanism, reversible or fixable, magnetic, rubber coated, 150 mm long
- 25 mm adapter
- 50 mm adapter
- magnetic extension rod: 60 mm
- „Y" type bit, Cr-V bits
- practical container box

⊖ flat	3; 4; 4,5; 5; 5,5; 6; 6,5; 7; 8
⊕ Phillips	PH0, PH1, 5 db PH2, PH3
⊕ Pz	PZ0, PZ1, 5 db PZ2, PZ3
⊗ Torx	T8, T10, T15, T20, T25, T27, T30, T40, T50
⊗ safety Torx	T8H, T10H, T15H, T20H, T25H, T27H, T30H, T35H, T40H
⊗ hexagon	1,5; 2; 2,5; 3; 4; 5; 5,5; 6; 8
⊗ hexagon	1/16", 5/64", 3/32", 7/64", 1/8", 9/64", 5/32", 3/16", 7/32", 1/4"
⊗ safety hexagon	2; 2,5; 3; 4; 5; 6
⊗ safety hexagon	5/64", 3/32", 7/64", 1/8", 9/64", 5/32"
⊖ square head	S0, S1, S2, S3
⊕ four-leg	6; 8; 10
⊖ three-leg	1; 2; 3; 4
⊖ forked	4; 6; 8; 10
⊗ clutch	C1, C2, C3
⊗ ribbed	M5, M6, M8



DE 101467

Bit set, 67 pcs

- 66 pcs 25 mm Cr-V bit
- 1 magnetic adapter
- practical, hanging container box



flat	3; 4; 4,5; 5; 5,5; 6; 6,5; 7
Phillips	2 x PH0, 2 x PH1, 2 x PH2, 3 x PH3
Pz	3 x PZ0, 3 x PZ1, 6 x PZ2, 3 x PZ3
square head	S0, S1, S2, S3
hexagon	1,5; 2; 2,5; 3; 3,5; 4; 4,5; 5; 5,5; 6
hexagon	1/16", 5/64", 3/32", 7/64", 1/8", 9/64", 5/32", 3/16", 7/32", 1/4"
Torx	T8, T9, T10, T15, T20, T25, T27, T30, T35, T40

DE 101551

Bit set, 20 pcs

- 1/4" size, 25 mm Cr-V bits
- hanging container box with belt clip



flat	3; 4; 5; 6; 7
Phillips	PH0, PH1, PH2, PH3
Pz	PZ0, PZ1, PZ2, PZ3
Torx	T10, T15, T20, T25
hexagon	4; 5; 6

DE 101484

Screwdriver set, ratchet, 21 pcs

- grip: 1/4" size, ratchet mechanism, reversible, fixable, magnetic, 115 mm long
- 1/4" size, 25 mm Cr-V bits
- practical, hanging container box



flat	3; 4; 5; 6
Phillips	PH0, PH1, PH2, PH3
Pz	PZ0, PZ1, PZ2, PZ3
Torx	T10, T15, T20, T25
hexagon	3; 4; 5; 6

DE 101483

Tool set, 31 pcs

- grip: 1/4" size, ratchet mechanism, reversible, fixable, magnetic, length: 113 mm
- 1/4"/4 mm adapter
- adapter for detachable sockets
- practical, hanging container box



Cr-V bits + detachable sockets:

flat	4; 5; 6
Phillips	PH1, PH2, PH3
Pz	PZ1, PZ2, PZ3
Torx	T10, T15, T20, T25
det. sockets	5; 6; 7; 8; 9; 10

Precision Cr-V bits:

flat	1; 1,5; 2; 2,5
Phillips	PH000, PH00, PH0, PH1

DE 101471

Toolset with ratchet mechanism, 38 pcs

- winch: 1/4" size, ratchet mechanism, reversible, 145 mm long
- adapter for bits
- rod extension: 70 mm long
- 1/4" size, 25 mm Cr-V bits
- practical, hanging container box



flat	3; 4; 5; 6; 7
Phillips	PH0, PH1, PH2, PH3
Pz	PZ0, PZ1, PZ2, PZ3
Torx	T10, T15, T20, T25, T27, T30, T40
hexagon	2; 3; 4; 5; 5,5; 6
det. sockets	5; 6; 7; 8; 9; 10; 11; 12; 13

DE 101489

Screwdriver set, precision, 31 pcs

- grip: rubber coated, rotating head, 110 mm long
- 28 mm long, Cr-V bits
- practical, hanging container box



flat	1; 1,5; 2; 2,5; 3; 4
Phillips	PH000, PH00, PH0, PH1
Pz	PZ0, PZ1
Torx	T4, T5, T6, T7, T8, T9, T10, T15, T20
hexagon	0,7; 0,9; 1; 1,3; 1,5; 2; 2,5; 3; 4

DE 101464

Screwdriver set with flexible shaft, precision, 33 pcs

- 30 pcs 28 mm-size Cr-V bits
- rubber coated grip
- flexible shaft
- magnifier
- practical, hanging container box



⊖ normal	1; 1,5; 2; 2,5; 3; 3,5; 4
⊕ Phillips	PH000, PH00, PH0, PH1
⊕ Pz	PZ0, PZ1
⊕ Torx	T4, T5, T6, T7, T8, T9, T10, T15, T20
⊕ hexagon	0,7; 0,9; 1,3; 1,5; 2; 2,5; 3; 4

CSH 1

Screwdriver set for technician, 6 pcs

- metal
- rotating cap for palm protection



⊖ flat	1,4; 2; 2,4; 3
⊕ Phillips	PH0, PH1

HW-229B

9 pcs hex key set



- with ball point head in one end
- long arm
- Chrome-Vanadium steel
- Complete with polyethylene holder

Pro'sKit®



⊕ hexagon-ball head	1,5; 2; 2,5; 3; 4; 5; 6; 8; 10
---------------------	--------------------------------

908-T301

Tweezers set for technician

- 150 mm long
- straight and bended in 45° tweezer
- knurled surface
- insulated coating

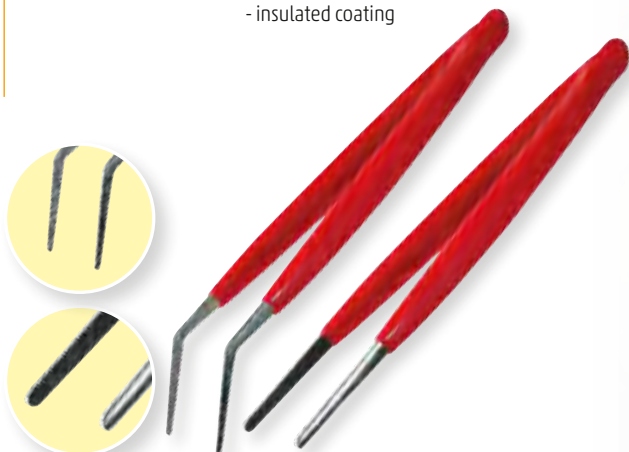

MA-019 Handheld LED light magnifier

Pro'sKit

- 8 pcs LED lights
- banknote: 1 pc UV LED
- high quality lens
- lens diameter: Ø56 mm
- magnifying: 3x (8 dioptries)
- electronic switch
- power supply: 3 x AAA (1,5 V) batteries, (not included)

8PK-MA006 Illuminated magnifier

Pro'sKit

- high quality lens
- lens diameter: Ø62 mm
- magnifying: 4x
- power supply: 2 x AA (1,5 V) batteries, (not included)
- bulb: 2,2 V/0,25 A/E 10

MA-022 Handheld LED light magnifier

Pro'sKit

- 1 pc LED light
- 1 pc UV LED for banknote detection
- high quality lens
- lens diameter: Ø27 mm
- magnifying: 7,5x (26 dioptries)
- with push button to switch on
- with slide switch to change function
- power supply: 2 x CR2016 (3V) battery, (not included)

8PK-MA003 Illuminated magnifier with headband

Pro'sKit

- basic lens + overlapping lens + slideable lens
- fixing with velcro tape
- visor against disturbing light effects:
- separately switchable lighting on the sides
- by combination of the 3 lenses, there are 3 kinds of magnification is available:
 - x 1,8/x 2,3/x 4,8
- power supply: 2 + 2 x AAA (1,5 V) battery, (not included)
- bulbs: 2 x 2,2V/0,25 A/ E10



Car multimedia devices

Our favourite audio- and video records can come with us when travelling. By using car radio, multimedia player and FM modulator, playback of sound and video records in the vehicle is not a problem anymore. There is a new touch screen type in our car radio and multimedia player supply, which can be controlled with the car steering wheel remote.



VB X700

Car radio and multimedia player



- sensitive touch-screen and quick access-keys
- multifunctional 7,0" (18 cm) TFT LCD screen
- double display; LCD display zone on the front panel
- theft inhibition: removable front panel
- radio/music/photo/video playback
- wireless BT connection
- listening to music from mobile phone, tablet
- making phone conversation without touching the phone
- making phone conversation hands-free
- phone directory and list of calls on the screen
- USB/SD/TF device can be connected
- safe, hidden SD card slot
- AM/FM radio with full RDS functionality
- receiving road information broadcasts
- photo album: zoom, rotation, slide show
- automatic back-up camera functions (option)
- clear file manager application
- option for two rear monitors for the passengers at the back seats
- controllable with the cars built-in steering wheel remote
- 5-language menu (GB/HU/SK/RO/SRB)
- 4 x 50 W Hi-Fi speaker output
- 3,5 mm AUX input for portable devices
- 2+2 x RCA amplifier/sub box output
- 2x video input and 2x video output



VB X100

Car radio and multimedia player



- multifunctional 3,0" TFT LCD display
- 5-language menu (GB/HU/SK/RO/SRB)
- radio/music/photo/video playback
- wireless BT connection
- making phone conversation hands-free
- USB/microSD/TF device is connectable
- safe, hidden microSD card slot
- AM/FM radio with RDS functions
- display of radio stations' name
- alternate frequency monitoring
- traffic information data reception
- searching for specific broadcast
- 12-band spectrum analyser
- Ø3,5 mm AUX input for portable devices
- 4 x 50 W Hi-Fi speaker output
- 2 x RCA amplifier/ subwoofer output
- automatic display of a rear view camera (optional) image
- 2 x video input & video output
- rear monitor options for passengers



VB 6000 Car radio and MP3/WMA player



4x45 Watt

- removable front panel with protective case
- RDS: PS/AF/CT/PTY/TP/TA
- 18 FM radio programmes and MP3/WMA playback
- USB/ SD/ SDHC/ MMC device is connectable
- safe, hidden SD-card socket
- searching for specific broadcast
- traffic information data reception
- alternate frequency monitoring
- displaying textual information
- direct access to programmes
- folder management/ stepping
- song introduction/ repeat/ random playback
- clock & large, easy-to-read display
- Ø3,5 mm AUX input for portable units
- 4 x 45 W Hi-Fi speaker output
- 4 x RCA amplifier/ subwoofer output
- ISO connector



VB 3000 Car radio and MP3 player

4x45 Watt

- 18 FM radio programmes and MP3/WMA playback
- clock & large, easy-to-read display
- optimized viewing angle
- USB/ SD/ SDHC/ MMC device is connectable
- music and loud-book playback
- recognises MP3 files, also in the subdirectories
- quick search for tracks
- advanced track memory
- song intro / repeat / shuffle play
- easy folder management
- Ø3,5 mm AUX input for portable units
- 4 x 45 W Hi-Fi speaker output
- 2 x RCA external amplifier/subwoofer output
- ISO connector



VB 2200 Car radio and MP3 player

4x25 Watt

- 15 FM radio programmes and MP3/WMA playback
- USB/ SD/ SDHC/ MMC device is connectable
- recognises files, also in the subdirectories
- song intro / repeat / shuffle play
- electronic volume- and menu control
- pop, rock...EQ & tone settings
- physiological tone adjustment (loudness)
- clock & bright, colour display
- Ø3,5 mm AUX input for portable units
- 4 x 25 W Hi-Fi speaker output
- 2 x RCA external amplifier/subwoofer output
- ISO connector



	VB X700	VB X100	VB 6000	VB 3000	VB 2200
LCD display	7" / 800x480 / CAPACITIVE TFT LCD	3" / 400X240 / TFT LCD	color	color	color
BT connection	✓	✓	-	-	-
built-in microphone	✓	✓	-	-	-
music playback	MKV, AVI, MP4, TS...	MP3, WMA, OGG...	MP3, WMA	MP3	MP3
video playing	MP3, WMA, OGG...	MKV, AVI, MP4, TS...	-	-	-
photo view	JPEG, BMP, GIF, PNG	JPEG, BMP, GIF, PNG	-	-	-
data storage socket	USB/SD	USB/ MICROSD	USB/ SD	USB/ SD	USB/ SD
file system	FAT 16/32, max. 32 GB	FAT 16/32, max. 32 GB	FAT 16/32, max. 32 GB	FAT 16/32, max. 32 GB	FAT 16/32, max. 32 GB
radio band	AM/FM	AM/FM	FM	FM	FM
radio storage place	12 + 18	12 + 18	18	18	15
RDS FUNCTION	PS/AF/TP/TA/PTY/EON	PS/AF/PTY/TP/TA	PS/AF/CT/PTY/TP/TA	-	-
output power	4 x 50 W	4 x 50 W	4 x 45 W	4 x 45 W	4 x 25 W
impedance	4 - 8 Ohm	4 - 8 Ohm	4 - 8 Ohm	4 - 8 Ohm	4 - 8 Ohm
frequency range	20 - 20000 Hz	20 - 20000 Hz	20 - 20000 Hz	20 - 20000 Hz	20 - 20000 Hz
bass boost	loudness	loudness	loudness	-	loudness
EQ TONE ADJUSTMENT	✓	✓	✓	-	✓
treble/bass tone	-	✓	✓	-	✓
clock displaying	✓	✓	✓	✓	✓
removable front panel	✓	-	✓	-	-
remote controller	✓	✓	✓	-	✓
AUX INPUT	stereo 3,5 mm	stereo 3,5 mm	stereo 3,5 mm	stereo 3,5 mm	stereo 3,5 mm
rear view camera input	1 x RCA	1 x RCA aljzat	-	-	-
video input	1 x RCA	1 x RCA aljzat	-	-	-
video output	2 x RCA	1 x RCA aljzat	-	-	-
audio output	2 x RCA	2 x RCA aljzat	4 x RCA socket	2 x RCA socket	2 x RCA socket
ISO CONNECTOR	✓	✓	✓	✓	✓
size	178 x 50 x 160 mm	178 x 50 x 130 mm	178 x 50 x 130 mm	178 x 50 x 130 mm	178 x 50 x 125 mm
weight	1600 g	620 g	600 g	540 g	700 g

DVR FHD1/BK

Car digital video recorder



- can serve as evidence for accidents
- FULL HD digital video recorder and camera
- movement detector and parking mode (automatically starts recording if it senses movements)
- detects acceleration - in case of crash it locks the recording
- 2,5" (6,4 cm) color LCD display
- wide, 140° angle of view, high quality glass lens
- night mode, infra-LED
- built-in microphone and speaker
- microSD card socket, max. 32 GB (card is not included)
- output: mini HDMI socket and 3,5 mm A/V output
- built-in Li-Po accumulator
- accessory: cigarette lighter connection cable for 12- 24 V vehicles, suction cup holder, miniUSB- USB connection cable
- size: 62 x 72 x 30 mm



SA 054

Rear view camera, colour



- it can save life, prevent accidents and damage of property
- you can see children, animals and smaller objects behind the car
- you can park your car quicker, more safely
- generally fits for the most of the vehicles
- suitable for connection to conforming car radio or individual monitor
- colour picture of camera automatically appears on the display on such car radios which are prepared for that (e.g. VB X700, VB X100)
- accessory c.a. 6 m video connection cable and power supply cable



FMBT 24

5in1 speakerphone and BT FM modulator



- BT speakerphone
- BT stereo music playback
- playing MP3 files from microSD data sources (max.32GB)
- double USB telephone charger, 5V/1,5 A max.
- stereo audio input, Ø3,5mm
- answering calls, disconnecting and rejecting calls, redialling without touching the phone
- automatic re-connection to the phone
- built-in microphone
- excellent sound quality (CVC, NR, Full Duplex, DSP)
- announcement of mode changing
- track- and frequency memory
- accessory: double charger, Ø3,5mm audio connecting cable, magnetic holder



FMBT 22

6in1 speakerphone and BT FM modulator

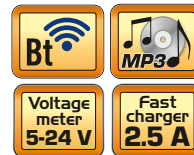

- BT speakerphone
- BT stereo music playback
- playing MP3/ WMA/WAV/FLV files from USB/microSD data sources (max.32GB)
- USB telephone quick charger, 5 V/2,5 A max.
- car Voltmeter (5-24 V); you can see if the power of the car battery is low
- stereo audio input, Ø3,5 mm
- answering calls, disconnecting and rejecting calls, re-calls without touching the phone
- automatic re-connection to the phone
- Voltmeter, frequency, track number, volume and BT modes on the display
- built-in microphone
- excellent sound quality (CVC, NR, Full Duplex, DSP)
- announcement of mode changing
- track- and frequency memory
- accessory: Ø3,5 mm audio connecting cable



BTRC 10

BT receiver with mobile phone hand-free option



- BT speakerphone
- BT stereo music playing
- BT adapter for head- and earphones
- built-in microphone
- automatic re-connection to the phone
- answering calls, disconnecting calls, re-calls without touching the phone
- remote control of the music player (play/pause)
- excellent sound quality (Full Duplex, DSP)
- announcement by switching operation modes
- automatic sleep mode after use
- accessories: 3,5 mm metal, dual plug, microUSB charging cable



FMBT 30

4in1 speakerphone and BT FM modulator



- BT speakerphone
- BT stereo music playing
- playing MP3/ WMA files from USB/microSD data sources (max.32GB)
- USB telephone quick charger, 5 V/ 1 A max.
- answering calls, disconnecting calls, cancelling calls, re-calls without touching the phone
- automatic re-connection to the phone
- frequency, track number, elapsed time, volume and BT modes on the display
- built-in microphone
- EQ sound settings
- direct track selection
- announcement by switching operation modes
- track- and frequency memory
- tiltable control surface
- accessory: remote controller (CR 2025 button cell, included)



SA 083

Mobile phone FM modulator

- can be amplified in the car or at home using any FM radio (87,6 - 107,9 MHz)
- phone conversation is audible through the car speakers
- built-in Lithium accumulator, microUSB charging cable is included
- bendable Ø3,5 mm stereo connection plug
- size: 60 x 25 x 12 mm

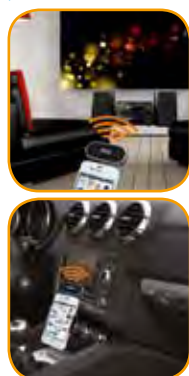

FMT 34

FM transmitter and charger



- playing MP3/ WMA files from USB/microSD data sources
- repeating and random playback programmes
- handling folders
- EQ sound settings
- track- and frequency memory
- mobile phone charger socket (500 mA)
- tiltable control panel
- remote controller, AUX cable



FMT 32

FM transmitter



- wireless connection with any kind of car radio
- playing MP3 files from USB/SD/microSD/SDHC/MMC data sources (max.16GB)
- EQ sound settings
- repeating songs and random playback
- handling folders
- track- and frequency memory
- tiltable control panel
- Ø3,5 mm AUX input
- power supply: 12-24 V



FMT 20

FM transmitter



- wireless connection with any kind of car radio (87,5 - 108,0 MHz)
- playing MP3 files from USB/SD/microSD/SDHC/MMC data sources (max.16GB)
- EQ sound settings
- repeating songs and random playback
- handling folders
- track- and frequency memory
- tiltable control panel
- Ø3,5 mm AUX input
- remote controller accessory (CR 1220 (3V) button cell, included)
- power supply: 12-24 V



Car sound system

There are sub tubes, boom boxes as well as speakers with different designs in our car Hi-Fi product range. The accessories required for installation are renewed in our catalog.



BS 10/A

Car subwoofer cabinet



Built-in amplifier, adjustable crossover

Subwoofer:

- Ø250 mm, polypropylene cone
- P_m/P_n: 200 / 150 W
- Z: 4 Ohm
- massive, dynamic-bass construction
- smaller-than-usual space requirement
- dimensions: 340 x 310 x 280 mm

Built-in amplifier:

- 100 W power output
- adjustable crossover: 35 - 200 Hz
- frequency range: 20 - 35 Hz / 20 - 200 Hz
- low level and high level inputs
- can be connected to any kind of car radios
- remote controlled on/off switching



XB-8/A

Active subtube



Built-in amplifier, adjustable crossover

Subwoofer:

- Ø200 mm speaker
- impregnated cellulose cone
- P_m/P_n: 120 / 80 Watt
- Z: 4 Ohm
- bass-reflex construction
- smaller-than-usual space requirement
- dimensions: 245 x 250 x 380 mm

Built-in amplifier:

- 50 W power output
- frequency range: 25 - 250 Hz
- high level (speaker) inputs
- can be connected to any kind of car radios

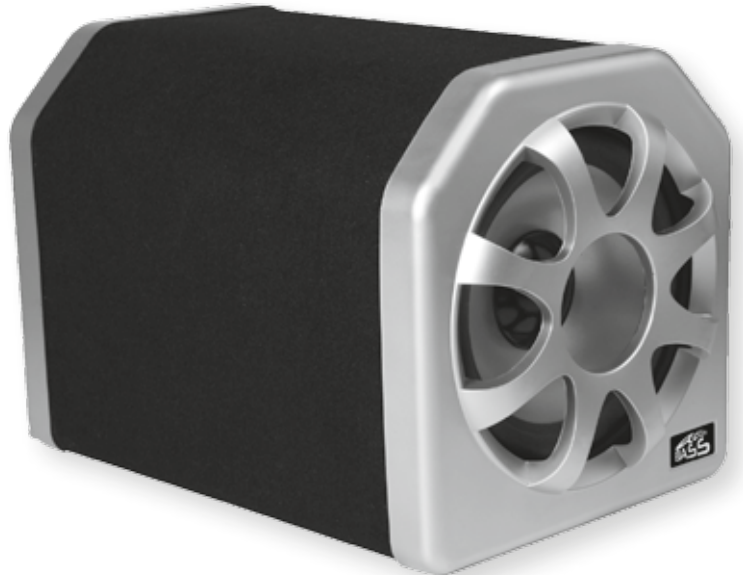

	BS 10/A	XB-8/A	BS 12	BS 10
speaker size	Ø250 mm	Ø200 mm	Ø300 mm	Ø250 mm
cone	polypropylene	impregnated cellulose	polypropylene	polypropylene
loadability	200 / 150 W	120 / 80 W	300 / 200 W	150 / 100 W
impedance	4 Ohm	4 Ohm	4 Ohm	4 Ohm
built-in amplifier	✓	✓	-	-
power output	100 W	50 W	-	-
adjustable crossover	35 - 200 Hz	-	-	-
frequency-range	20-35 Hz / 20-200 Hz	25 - 250 Hz	22 - 3200 Hz	35 - 3500 Hz
low level input	✓	-	-	-
high level input	✓	✓	✓	✓
controllable on/off switch	✓	-	-	-
protective grid	-	✓	-	-
construction	closed	bass-reflex soundbox	bass-reflex soundbox	closed
size	340 x 310 x 280 mm	245 x 250 x 380 mm	470 x 370 x 260 mm	355 x 300 x 180 mm

BS 12

Car subwoofer cabinet



- P_m/P_n: 300 / 200 W
- Ø300 mm speaker
- f: 22 - 3 200 Hz
- polypropylene cone
- bass- reflex construction
- cable clips
- smaller-than-usual space requirement
- heavy duty curved corners
- dimensions: 470 x 370 x 260 mm



BS 10

Car subwoofer cabinet



- P_m/P_n: 150 / 100 W
- Ø250 mm speaker
- f: 35 - 3 500 Hz
- polypropylene cone
- dynamic-bass, closed construction
- cable clips
- especially thin design
- heavy duty curved corners
- dimensions: 355 x 300 x 180 mm



SBF 2025

Universal car amplifier

50 W



- 50 W (2 x 25 W) / 2 x 4 Ohm
- 3 way of crossover operation modes: for subwoofers, midrange speakers and tweeters and wide range speakers
- integrated circuit of final amplifier
- volume control
- high and low level line input
- indicator LED, gilded RCA connection sockets
- 3 kinds of cable accessories
- dimensions: 65 x 40 x 100 mm



AHX 1620/BK

Subwoofer

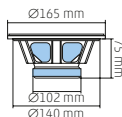

- P_m/P_n: 60/40 W
- f: 50 - 7.000 Hz
- SPL_{1W/1m}: 88 dB
- voice coil: 1", 2 layers
- voice coil material: ALU
- magnet weight: 20 Oz



AHX 2030/BK

Subwoofer

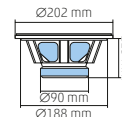

- P_m/P_n: 120/80 W
- f: 40 - 4.000 Hz
- SPL_{1W/1m}: 88 dB
- voice coil: 1,5", 4 layers
- voice coil material: ALU
- magnet weight: 30 Oz

XB-1012/A/T

Power cable for active sub systems

- Recommended for SAL active sub-systems: XB-10/A, XB-12/A, RX-10/A, RX-12/A, WRC 12BP/A
- 12 Volt/ 2 x 1,5 mm² + 1 x 0,75 mm²
 - 5 meter



AP 17 Tweeter pair, piezo



- P_m: 160 W (2 x 80 W max.)
- f: 5.000 - 22.000 Hz
- SPL_{1W/1m}: 95 dB
- Z: >1.000 Ω
- U_{max}: 18 V~
- built-in crossover
- can be fixed with glue or with screws
- fittings included for installation



ADT 40 Tweeter pair, dome



- P_m: 160 W (2 x 80 W)
- P_n: 80 W (2 x 40 W)
- f: 5.000 - 21.000 Hz
- SPL_{1W/1m}: 90 dB
- voice coil: 0,5"
- cone: MYLAR
- magnet: neodymium
- built-in crossover



WRX 310 Car speaker pair



- 3 way
- bass: Ø100 mm PEI cone
- midrange: Ø30 mm mylar dome
- tweeter: Ø15 mm piezo
- loadability: 140 W (2 x 70 W max.)
- frequency range: 60 - 20000 Hz
- sensitivity: 86 dB

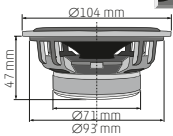

WRX 313 Car speaker pair



- 3 way
- bass: Ø130 mm PEI cone
- midrange: Ø30 mm mylar dome
- tweeter: Ø15 mm piezo
- loadability: 180 W (2 x 90 W max.)
- frequency range: 50 - 20000 Hz
- sensitivity: 87 dB

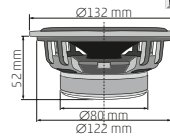

WRX 316 Car speaker pair



- 3 way
- bass: Ø165 mm PEI cone
- midrange: Ø30 mm mylar dome
- tweeter: Ø15 mm piezo
- loadability: 220 W (2 x 110 W max.)
- frequency range: 45 - 20000 Hz
- sensitivity: 88 dB

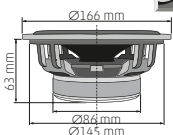

WRX 469 Car speaker pair



- 4 way
- bass: 6 x 9" mm PEI cone
- midrange: Ø52 mm mylar dome
- midrange-tweeter: Ø30 mm mylar dome
- tweeter: Ø15 mm piezo
- loadability: 260 W (2 x 130 W max.)
- frequency range: 40 - 21000 Hz
- sensitivity: 89 dB

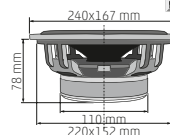

CX 404

Car speaker pair



- 2 way
- midrange: Ø100 mm PP cone
- tweeter: Ø30 mm mylar dome
- loadability: 110 W (2 x 55 W max.)
- frequency range: 55 - 20000 Hz
- sensitivity: 88 dB

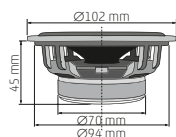

CX 504

Car speaker pair



- 2 way
- midrange: Ø130 mm PP cone
- tweeter: Ø30 mm mylar dome
- loadability: 150 W (2 x 75 W max.)
- frequency range: 50 - 20000 Hz
- sensitivity: 89 dB

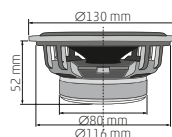

CX 604

Car speaker pair



- 2 way
- midrange: Ø165 mm PP cone
- tweeter: Ø35 mm mylar dome
- loadability: 200 W (2 x 100 W max.)
- frequency range: 45 - 20000 Hz
- sensitivity: 90 dB

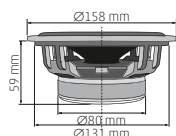

CX 695

Car speaker pair



- 3 way
- subwoofer: 6 x 9" PP cone
- midrange-tweeter: Ø35 mm mylar dome
- tweeter: Ø27 mm piezo
- loadability: 240 W (2 x 120 W max.)
- frequency range: 40 - 20000 Hz
- sensitivity: 92 dB

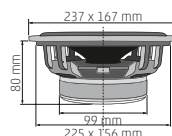

	WRX 310	CX 404	WRX 313	CX 504	WRX 316	CX 604	WRX 469	CX 695
rated diameter	100 mm		130 mm		165 mm		6 x 9"	
construction	3 way	2 way	3 way	2 way	3 way	2 way	4 way	3 way
subwoofer	Ø100 mm, PEI cone	Ø100 mm, PP cone	Ø130 mm, PEI cone	Ø130 mm, PP cone	Ø165 mm, PEI cone	Ø165 mm, PP cone	6 x 9", PEI cone	6 x 9", PP cone
midrange speaker	Ø30 mm, mylar	-	Ø30 mm, mylar	-	Ø30 mm, mylar	-	Ø52 mm, mylar	Ø35 mm, mylar
midrange-tweeter	-	-	-	-	-	-	Ø30 mm, mylar	-
tweeter	Ø15 mm, piezo	Ø30 mm, mylar	Ø15 mm, piezo	Ø30 mm, mylar	Ø15 mm, piezo	Ø35 mm, mylar	Ø20 mm, piezo	Ø27 mm, piezo
loadability	2 x 70 W	2 x 55 W	2 x 90 W	2 x 75 W	2 x 110 W	2 x 100 W	2 x 130 W	2 x 120 W
impedance	4 Ohm	4 Ohm	4 Ohm	4 Ohm	4 Ohm	4 Ohm	4 Ohm	4 Ohm
frequency range	60 - 20000 Hz	55 - 20000 Hz	50 - 20000 Hz	50 - 20000 Hz	45 - 20000 Hz	45 - 20000 Hz	40 - 21000 Hz	40 - 20000 Hz
sensitivity	86 dB	88 dB	87 dB	89 dB	88 dB	90 dB	89 dB	92 dB
edge	rubber	rubber	rubber	rubber	rubber	rubber	rubber	rubber
basket	aluminum cast	steel	aluminum cast	steel	aluminum cast	steel	aluminum cast	steel
grid	✓	✓	✓	✓	✓	✓	✓	✓
built-in size	Ø93 mm	Ø94 mm	Ø122 mm	Ø116 mm	Ø145 mm	Ø131 mm	220 x 152 mm	225 x 156 mm
built-in depth	47 mm	45 mm	52 mm	52 mm	63 mm	59 mm	78 mm	80 mm

BK 087

Car speaker pair



- dual cone
- midrange speaker: Ø 87 mm cellulose cone
- tweeter: PEI cone
- loadability: 70 W (2 x 35 W max.)
- frequency range: 75 - 18500 Hz
- sensitivity: 85 dB

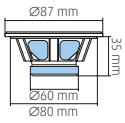

BK 100

Car speaker pair



- dual cone
- midrange speaker: Ø100 mm cellulose cone
- tweeter: PEI cone
- loadability: 90 W (2 x 45 W max.)
- frequency range: 55 - 19000 Hz
- sensitivity: 85 dB

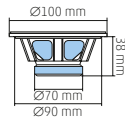

BK 130

Car speaker pair



- dual cone
- midrange speaker: Ø130 mm cellulose cone
- tweeter: PEI cone
- loadability: 100 W (2 x 50 W max.)
- frequency range: 50 - 19000 Hz
- sensitivity: 86 dB

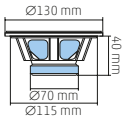

BK 165

Car speaker pair



- dual cone
- midrange speaker: Ø165 mm cellulose cone
- tweeter: PEI cone
- loadability: 150 W (2 x 75 W max.)
- frequency range: 45 - 19000 Hz
- sensitivity: 86 dB

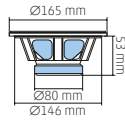

We would like to draw your attention to our protective grid supply, shown on page 194.

MRPX 2-130

Waterproof speaker pair

100W

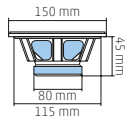

- 2 way, coaxial
- Ø30 mm dome tweeter
- loadability: 100 W (2 x 50 W)
- frequency range: 50 - 20000 Hz
- sensitivity: 86 dB
- ideal for use in damp, humid conditions: infra sauna, swimming pool, bathroom, patio, camping car, ship

MRPX 2-165

Waterproof speaker pair

150W

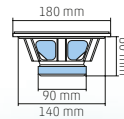

- 2 way, coaxial
- Ø30 mm dome tweeter
- loadability: 150 W (2 x 75 W)
- frequency range: 45 - 20000 Hz
- sensitivity: 87 dB
- ideal for use in damp, humid conditions: infra sauna, swimming pool, bathroom, patio, camping car, ship



SA 333

Car HiFi cable set

1000 Watt
80 Amper
4 GA 20 mm²

- total 42-piece set
- 1000 W / 80 A / 20 mm²
- OFC Hi-Fi stereo audio cable
- premium quality, extra flexible
- complete solution for secure connection of power supply and head unit
- for connecting active subwoofers, sound cabinets, subtubes, amplifiers



Power cable, blue, +12V	4GA / 20 mm ² - 5,2 m / Ø9,6 mm
GND cable, black	4GA / 20 mm ² - 0,9 m / Ø9,6 mm
Speaker wire, blue-black	18GA / 0,75 mm ² - 6,1 m / Ø3,0 mm
Stereo audio cable, blue	2 x RCA - 2 x RCA / 5,2 m / Ø4,0 mm
Remote cable, blue, +12V	5,2 m / Ø2,5 mm
Fuse holder, fuse	80 Amper AGU fuse (10 x 38 mm)
Flexible black tubing	4GA / 1,2 m / Ø13 mm
Ring terminal	2 x Ø8,2 mm / M8

Forked terminal	2 x Ø5,2 mm / M5
Forked terminal	5 x Ø4,2 mm / M4
Flat terminal	4 x 7,5 mm
Insulation for power cable	2x Black + 2x Blue
Insulation for forked terminal	2x Black + 3x Blue
Insulation for flat terminal	2x Black + 2x Blue
Cable tie, black	8 x 150 mm

SA 030

Car HiFi power capacitor

- capacity: 1,0 Farad / 18 V DC
- max. voltage: 20 V DC / 95 °C
- internal resistance: < 0,0015 Ohm
- Voltmeter with 3 red digits
- improves the car's stereo sound quality
- provides high current demanded by music transients
- conserves battery power and protects the vehicle's electric system
- accessory bracket, screws, connectors, tool
- dimension: Ø 76 x 260 mm



SA 001

High-low level converter

VOLUME **2 CH**
GOLD

- makes connection available for such amplifiers with car radios, which are not equipped with connector which is suitable for that purpose
- convert speaker output to RCA socket
- max. 2 x 50 W input power
- frequency range: 20 - 35000 Hz
- max. attenuation: 60 dB
- output impedance: 10 kOhm
- size: 90 x 65 x 27 mm

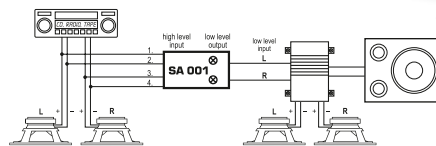

HV 621

Crossover

4 **2 WAY**

- max. 200 W
- crossover frequency: 2500 Hz
- crossover filter: 6 dB/octave
- gilded terminals blocks
- size: 65 x 35 x 120 mm

HV 623

Crossover

4 **3 WAY**

- max. 200 W
- crossover frequency: 700/5000 Hz
- crossover filter: 6 dB/octave
- gilded terminals blocks
- size: 65 x 35 x 120 mm

HVS 14

Crossover

4 **1 WAY**

- max. 300 W
- cutting frequency: 120 Hz / 160 Hz
- crossover filter: 12 dB/octave
- for subwoofers
- size: 70 x 45 x 90 mm



Sound systems

We have widened our sound system product range with several new items. With the use of our multimedia boombox which is having Bluetooth connection, old analogue recordings can be digitized (records, cassettes, CD). We recommend our portable radios for the lovers of retro style, where multimedia player can be found among them. Professional orchestra cabinets and microphone sets fulfil any kind of requirements.



BT MAX

6in1 multimedia boombox

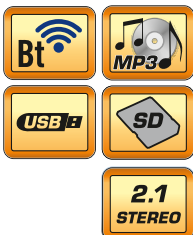

- excellent Hi-Fi sound quality
- 2.1 Stereo & Extra Bass speakers
- bass and treble equalizer and EQ
- wireless BT connection
- listening to music from mobile devices or computer
- playing MP3 files from USB/SD/SDHC/MMC devices
- FM radio with automatic station seeking
- digitizing old analogue recordings
- recording to USB/SD devices
- wired audio input (AUX IN)
- 2 x KARAOKE microphone input
- adjustable echo effect
- announcement by shifting operation modes, it can be switched off
- separately switchable blue LED light
- classic wooden sound box, with carrying handle
- inputs: USB/SD, 2 x 6,3 mm MIC, 2 x RCA LINE
- accessories: remote controller (2 x AAA/1,5 V (not included)) and 3,5 mm-2 x RCA AUX cable
- dimensions: 360 x 230 x 310 mm / 5,6 kg



BT 1650

Portable multimedia speaker box with BT connection



- wireless BT connection
- listening to music from mobile devices or computer
- playing MP3 files from SD/ USB devices
- KARAOKE microphone input
- FM radio with automatic station seeking
- wire access (AUX IN)
- announcement when changing mode
- constant color changing with LED
- MP3 & radio remote control
- classic wooden sound cabinet with carrying handle
- inbuilt Li-Ion battery
- included USB-micro USB charging cable / AUX cable
- dimensions: 200 x 300 x 160 mm



Constant color changing with LED

BT 2800/BL

Portable multimedia speaker box with BT connection

- blue



- wireless BT connection
- listening to music from mobile devices or computer
- playing MP3 files from SD/ USB devices
- FM radio with automatic station seeking
- wire access (AUX IN)
- 5 way of EQ tone adjustment mode (MP3)
- 4 way of repeating/random MP3 playing
- announcement when changing mode
- constant color changing with LED
- MP3 & radio remote control included
- classic wooden sound cabinet with carrying handle
- double speaker - double bass
- inbuilt Li-Ion battery
- accumulator capacity is expandable: (option: BL- 5C)
- accessory: 0,5 m USB-micro USB charging cable / AUX cable
- dimensions: 140 x 285 x 110 mm

BT 2800/GR

- green



BT 2400

Portable multimedia speaker box with BT connection



- STEREO - XTRA BASS
- excellent, crystal clear sound
- wireless BT connection
- listening to music from mobile devices or computer
- remote control of mobile phone music player
- playing MP3 files from USB/ microSD devices
- FM radio with automatic station seeking
- automatic storing of FM stations
- wired output (EXT OUT), wired input (AUX IN)
- connectable headphone
- speakerphone function for phone calls
- announcement when changing mode
- track memory
- inbuilt microphone
- replaceable Li-Ion accumulator
- USB - miniUSB charging cable and 3,5 mm - 3,5 mm OUT / IN / FM antenna cable included
- dimensions: 215 x 70 x 70 mm

FM band	87,0-108,0 MHz / 35pr
File system	FAT16/32, max.32 GB
BT version	2.1 + EDR / 10 m max.
BT profiles	2.1 / A2DP, V1.2, AVRCP, V1.4 / 10 m, A2DP, V1.2, AVRCP, V1.4
Power output	2 x 3 Watt / 4 Ohm
Stereo speakers	2 x 45 mm + XTRA BASS
Frequency range	160 - 20.000 Hz
Accumulator	Li-Ion / 3,7 V - 670 mAh
Operation / charging time	4-6 óra / 6 óra max.
Dimension / weight	215 x 70 x 70 mm / 350 g



portable multimedia speaker box

RRT 3B Retro portable radio and multimedia player

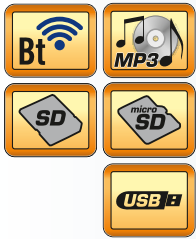

- 4in1: BT + MP3 + AUX + radio
- wireless BT connection
- listening to music from mobile device or computer
- playing MP3 files from USB/SD/microSD devices
- wired audio input (AUX IN)
- 3-band AM-FM-SW radio
- volume indicator 2 x 5 LEDs
- voice announcement by changing operation modes
- classic wooden box with carrying handle
- various power supply: built-in accumulator, 4xD/LR20 (1,5 V) battery (not included), external 6 V adapter or accumulator (not included), accessory power cable for charging
- size: 27 x 20 x 13 cm



RPR 4B Portable radio

- 4-band AM-FM-SW1-SW2 radio
- excellent sound, clear voice
- extra high-sensitivity receiver
- extra-long operation time with batteries
- Ø3,5 mm headphone socket
- with long strap for hanging on wall or furniture
- power supply: 2xD/LR20 (1,5 V) battery, not included
- dimensions: 20,5 x 13 x 5,6 cm/ 360 g



RPR 2B Portable radio

- 2-band AM-FM radio
- excellent sound, clear voice
- extra high-sensitivity receiver
- extra-long operation time with batteries
- LED operation indicator
- Ø3,5 mm headphone socket
- power adapter socket, 3 V, not included, (e.g.: MW 3N06)
- power supply: 2xD/LR20 (1,5 V) battery, not included
- dimensions: 15,5 x 10 x 4,5 cm/ 300 g



RPC 2BX Pocket radio

- featured and easy to use button for tuning
- indicator LED of exact tuning
- Ø3,5 mm headphone connector
- power supply: 2xAA (1,5V) battery, not included
- size: 12 x 7 x 3,2 cm/ 140 g



RPC 2B Pocket radio

- 2-band AM-FM radio
- LED operation mode indicator
- Ø3,5 mm headphone connector
- power supply: 2xAA (1,5V) battery, not included
- size: 7 x 11,5 x 2,7 cm/ 80 g



SAL 20 ACTIVE

Active speaker cabinet pair **240 W**



- P: 2 x 120/80 W, f: 35 - 21.000 Hz
- bass-midrange speaker: Ø200 mm
- midrange speaker: Ø100 mm
- tweeter: 1" silk dome
- built-in mixer-amplifier
- KARAOKE function
- microphone echo circuit
- trouble/bass tone adjustment
- microphone input: 2 x Ø6,3 mm socket (MIC)
- audio input: 2 x RCA socket (L+R)
- speaker connector: clip
- power supply: 230 V~/50 Hz
- size: 24 x 60 x 32 cm (x 2 pcs)



speaker box

SAL 10A/BK

Active speaker cabinet pair **80 W**



- ideal for computers, music players
- P: 2 x 40/20 W, f: 50 - 20.000 Hz
- woofer: Ø115 mm
- tweeter: 1" mylar dome
- trouble/bass tone adjustment
- audio input: 2 x RCA socket (L+R)
- first class quality, MDF wooden housing
- accessory: Ø3,5 mm - 2 x RCA connection cable
- power supply: 230 V~/50 Hz
- size: 14 x 23 x 20 cm (x 2 pcs)



SAL 2610S

Speaker box (1 pc) **85 W**



- P_m/P_n: 85/60 W, Z: 8 Ohm
- SPL_{1w/1m}: 89 dB, f: 65-20.000 Hz
- construction: 2-way, bass- reflex sound box
- speakers:
 - woofer: Ø135 mm polypropylene
 - tweeter: 0,75" metal plated mylar dome
- clip cable connector, removable front panel, metal wall hanger
- dimensions: 18 x 32 x 18,5 cm



SBX 1010/BK

Woofer

50 W



- P_m/P_n: 50/35 W
- f: 55 - 8.000 Hz
- SPL_{1W/1m}: 82 dB
- voice coil: 0,75", 2 layers
- voice coil material: aluminum
- magnet weight: 10 Oz

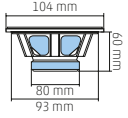

SBX 1320/BK

Woofer

60 W



- P_m/P_n: 60/40 W
- f: 50 - 7.000 Hz
- SPL_{1W/1m}: 85 dB
- voice coil: 1", 4 layers
- voice coil material: aluminum
- magnet weight: 20 Oz

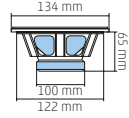

SBX 1620/BK

Woofer

80 W



- P_m/P_n: 80/50 W
- f: 45 - 7.000 Hz
- SPL_{1W/1m}: 87 dB
- voice coil: 1", 4 layers
- voice coil material: aluminum
- magnet weight: 20 Oz

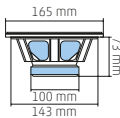

SBX 2030/BK

Woofer

120 W



- P_m/P_n: 120/80 W
- f: 35 - 3.000 Hz
- SPL_{1W/1m}: 88 dB
- voice coil: 1,5", 4 layers
- voice coil material: aluminum
- magnet weight: 30 Oz

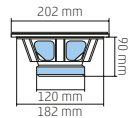

SBX 2530/BK

Subwoofer

150 W



- P_m/P_n: 150/100 W
- f: 30 - 2.500 Hz
- SPL_{1W/1m}: 90 dB
- voice coil: 1,5", 4 layers
- voice coil material: aluminum
- magnet weight: 30 Oz

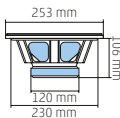

SBX 3040/BK

Subwoofer

150 W



- P_m/P_n: 150/120 W
- f: 28 - 2.000 Hz
- SPL_{1W/1m}: 89 dB
- voice coil: 2", 4 layers
- voice coil material: aluminum
- magnet weight: 40 Oz

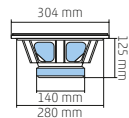

SBX 4060/BK

Subwoofer

200 W



- P_m/P_n: 200/150 W
- f: 25 - 1.800 Hz
- SPL_{1W/1m}: 90 dB
- voice coil: 2,5", 4 layers
- voice coil material: aluminum
- magnet weight: 60 Oz

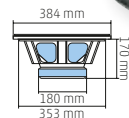

	SBX 1010/BK	SRP 1010	SBX 1320/BK	SRP 1315	SBX 1620/BK	SRP 1620
nominal diameter	100 mm	100 mm	130 mm	130 mm	165 mm	165 mm
cone	kevlar	polypropylene	kevlar	polypropylene	kevlar	polypropylene
power	50 / 35 W	50 / 35 W	60 / 40 W	50 / 35 W	80 / 50 W	60 / 40 W
impedance	8 Ohm	8 Ohm	8 Ohm	8 Ohm	8 Ohm	8 Ohm
frequency range	55 - 8000 Hz	55 - 8000 Hz	50 - 7000 Hz	55 - 7000 Hz	45 - 7000 Hz	45 - 5000 Hz
SPL	82 dB	83 dB	85 dB	84 dB	87 dB	87 dB
voice coil	∅0,75", 2 layers	∅1", 2 layers	∅1", 4 layers	∅1", 2 layers	∅1", 4 layers	∅1", 4 layers
coil material	aluminum	aluminum	aluminum	aluminum	aluminum	aluminum
edge	rubber	rubber	rubber	rubber	rubber	rubber
basket	steel plate	steel plate	steel plate	steel plate	steel plate	steel plate
magnet	10 Oz	10 Oz	20 Oz	15 Oz	20 Oz	20 Oz
mounting size	∅93 mm	∅93 mm	∅122 mm	∅123 mm	∅143 mm	∅148 mm
mounting depth	60 mm	60 mm	65 mm	65 mm	73 mm	65 mm

We would like to draw your attention to our protective grid supply, shown on page 194.

woofer and subwoofer

SRP 1010 **50 W** **Woofer**

- P_m/P_n: 50/35 W
- f: 55 - 8.000 Hz
- SPL_{1W/1m}: 83 dB
- voice coil: 1", 2 layers
- voice coil material: aluminum
- magnet weight: 10 Oz

SRP 1315 **50 W** **Woofer**

- P_m/P_n: 50/35 W
- f: 55 - 7.000 Hz
- SPL_{1W/1m}: 84 dB
- voice coil: 1", 2 layers
- voice coil material: aluminum
- magnet weight: 15 Oz

SRP 1620 **60 W** **Subwoofer**

- P_m/P_n: 60/40 W
- f: 45 - 5.000 Hz
- SPL_{1W/1m}: 87 dB
- voice coil: 1", 4 layers
- voice coil material: aluminum
- magnet weight: 20 Oz

SRP 2030 **80 W** **Subwoofer**

- P_m/P_n: 80/50 W
- f: 30 - 4.000 Hz
- SPL_{1W/1m}: 89 dB
- voice coil: 1,5", 4 layers
- voice coil material: aluminum
- magnet weight: 30 Oz

SBV 2020/4 **80 W** **Subwoofer**

Suitable for repair VIDEOTON sound boxes!

- P_m/P_n: 80/50 W
- f: 45 - 5.000 Hz
- SPL_{1W/1m}: 86 dB
- voice coil: 1", 2 layers
- voice coil material: aluminum
- magnet weight: 20 Oz

SBV 2020 **80 W** **Subwoofer**

Suitable for repair VIDEOTON sound boxes!

- P_m/P_n: 80/50 W
- f: 45 - 5.000 Hz
- SPL_{1W/1m}: 85 dB
- voice coil: 1", 2 layers
- voice coil material: aluminum
- magnet weight: 20 Oz

SBV 2530 **100 W** **Subwoofer**

Suitable for repair VIDEOTON sound boxes!

- P_m/P_n: 100/70 W
- f: 35 - 4.800 Hz
- SPL_{1W/1m}: 87 dB
- voice coil: 1", 2 layers
- voice coil material: aluminum
- magnet weight: 30 Oz

Woofer and subwoofer

SBV 2020/4 and 2020	SBX 2030/BK	SRP 2030	SBX 2530/BK	SBV 2530	SBX 3040/BK	SBX 4060/BK
200 mm	200 mm	200 mm	250 mm	250 mm	300 mm	400 mm
impregnated paper	kevlar	polypropylene	kevlar	impregnated paper	kevlar	kevlar
800 / 50 W	120 / 80 W	80 / 50 W	150 / 100 W	100 / 70 W	150 / 120 W	200 / 150 W
4 Ohm / 8 Ohm	8 Ohm	8 Ohm	8 Ohm	8 Ohm	8 Ohm	8 Ohm
45 - 5000 Hz	35 - 3000 Hz	30 - 4000 Hz	30 - 2500 Hz	35 - 4800 Hz	28 - 2000 Hz	25 - 1800 Hz
86 db / 85 db	88 dB	89 dB	90 dB	87 db	89 dB	90 dB
Ø1", 2 layers	Ø1,5", 4 layers	Ø1,5", 4 layers	Ø1,5", 4 layers	Ø1", 2 layers	Ø2", 4 layers	Ø2,5", 4 layers
aluminum	aluminum	aluminum	aluminum	aluminum	aluminum	aluminum
rubber	rubber	rubber	rubber	rubber	rubber	rubber
steel plate	steel plate	steel plate	steel plate	steel plate	steel plate	steel plate
20 Oz	30 Oz	30 Oz	30 Oz	30 Oz	40 Oz	60 Oz
Ø183 mm	Ø182 mm	Ø183 mm	Ø230 mm	Ø230 mm	Ø280 mm	Ø353 mm
80 mm	90 mm	85 mm	106 mm	106 mm	125 mm	170 mm

We would like to draw your attention to our protective grid supply, shown on page 194.

SPA 2030

Subwoofer

150W



- P_m/P_n: 150/100 W
- f: 50 - 5.000 Hz
- SPL_{1W/1m}: 89 dB
- voice coil: 1,5", 2 layers
- voice coil material: aluminum
- magnet weight: 30 Oz

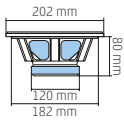

SPA 2530

Subwoofer

200W



- P_m/P_n: 200/140 W
- f: 45 - 5.000 Hz
- SPL_{1W/1m}: 90 dB
- voice coil: 1,5", 2 layers
- voice coil material: aluminum
- magnet weight: 30 Oz

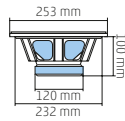

SPA 3040

Subwoofer

210W



- P_m/P_n: 210/150 W
- f: 40 - 3.500 Hz
- SPL_{1W/1m}: 90 dB
- voice coil: 1,5", 2 layers
- voice coil material: aluminum
- magnet weight: 40 Oz

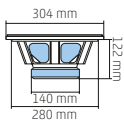

SPA 4050

Subwoofer

230W



- P_m/P_n: 230/160 W
- f: 30 - 3.000 Hz
- SPL_{1W/1m}: 93 dB
- voice coil: 2", 2 layers
- voice coil material: aluminum
- magnet weight: 50 Oz

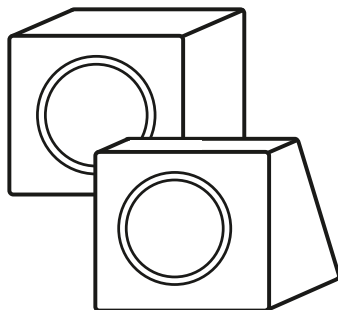
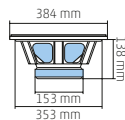

type	Vn	construction
SPA 2030	20 l	closed speaker cabinet
SPA 2530	32 l	closed speaker cabinet
SPA 3040	40 l	closed speaker cabinet
SPA 4050	65 l	closed speaker cabinet

HVP 28

Crossover

600W



- loadability: max. 600 W
- crossover frequency: 2.800 Hz
- frequency filter, bass: 12 dB/octave
- frequency filter, treble: 18 dB/octave
- professional, for amplifier systems
- 150 x 28 x 95 mm



	SPA 2030	SPA 2530	SPA 3040	SPA 4050	SKN 10	SKN 13
nominal diameter	200 mm	250 mm	300 mm	400 mm	112x112 mm	135x135 mm
cone	paper	paper	paper	paper	impregnated paper	impregnated paper
power	150/100 W	200/140 W	210/150 W	230/160 W	40/30 W	50/40 W
impedance	8 Ohm	8 Ohm	8 Ohm	8 Ohm	8 Ohm	8 Ohm
frequency range	50-5000 Hz	45-5000 Hz	40-3500 Hz	30-3000 Hz	500-8500 Hz	400-7000 Hz
SPL	89 dB	90dB	90 dB	93 dB	84 dB	86 dB
voice coil	1.5", 2 layers	1.5", 2 layers	1.5", 2 layers	2", 2 layers	2 layers	2 layers
coil material	aluminum	aluminum	aluminum	aluminum	aluminum	aluminum
edge	textile	textile	textile	textile	foam	foam
basket	steel	steel	steel	steel	closed, steel	closed, steel
magnet	30 Oz	30 Oz	40 Oz	50 Oz	12xØ60 mm	10xØ70 mm
mounting size	182 mm	232 mm	280 mm	353 mm	Ø92 mm	Ø108 mm
mounting depth	80 mm	100mm	122 mm	138 mm	41 mm	42mm

SKN 10 Midrange speaker

- professional, closed basket
- it does not require hermetically separated air space from the speaker box
- stiffed, impregnated cone
- P_m/P_n : 40/30 W
- f: 500-8.500 Hz
- $SPL_{1W/1m}$: 84 dB

40 W

SKN 13 Midrange speaker

- professional, closed basket
- it does not require hermetically separated air space from the speaker box
- stiffed, impregnated cone
- P_m/P_n : 50/40 W
- f: 400-7.000 Hz
- $SPL_{1W/1m}$: 86 dB

50 W

SKN 16 Midrange speaker

- professional, closed basket
- it does not require hermetically separated air space from the speaker box
- stiffed, impregnated cone
- P_m/P_n : 60/40 W
- f: 300-6.000 Hz
- $SPL_{1W/1m}$: 88 dB

60 W

ARZ 081 Wide-range speaker

Ideal for repairing purposes!

- P_m : 0,25 W
- f: 300 - 8.000 Hz
- typical speaker for pocket radios

0,25 W

YD 78 Wide-range speaker

Ideal for repairing purposes!

- P_m : 2 W
- f: 270 - 8.000 Hz
- typical speaker for portable radios

2 W

DT 20 Dome tweeter

- P_m/P_n : 40/20 W
- f: 3.000 - 21.000 Hz
- $SPL_{1W/1m}$: 91 dB
- voice coil: 0,5"
- cone: mylar
- magnet weight: 2 x 0,6 Oz

DTF 12 Dome tweeter

- P_m/P_n : 100/50 W
- f: 2.000 - 21.000 Hz
- $SPL_{1W/1m}$: 91 dB
- voice coil: 1"
- cone: silk
- magnet weight: 8 Oz

DT 6 Dome tweeter

- P_m/P_n : 100/50 W
- f: 2.000 - 20.000 Hz
- $SPL_{1W/1m}$: 91 dB
- voice coil: 1"
- cone: mylar
- magnet weight: 8 Oz

It is same as the tweeter of our SAL 3610F speaker boxes.

DT 5 Dome tweeter

- P_m/P_n : 100/50 W
- f: 2.000 - 20.000 Hz
- $SPL_{1W/1m}$: 91 dB
- voice coil: 1"
- cone: mylar
- magnet weight: 8 Oz

It is same as the tweeter of our SAL 2610F speaker boxes.

SKN 16	ARZ 081	YD 78	DT 20	DTF 12	DT 6	DT 5
170x170 mm	Ø65 mm	Ø77 mm	Ø73 mm	103 mm	103 mm	90x115 mm
impregnated paper	paper	paper	mylar	silk	mylar	mylar
60/40 W	1 W	2 W	40/20 W	100/50 W	100/50 W	100/50 W
8 Ohm	8 Ohm	8 Ohm	8 Ohm	8 Ohm	8 Ohm	8 Ohm
300-6000 Hz	300-8000 Hz	270-8000 Hz	3000-21000 Hz	1500-21000 Hz	2000-20000 Hz	2000-20000 Hz
88 dB			91 dB	91 dB	91 dB	91 dB
2 layers	0,5"	0,5"	0,5"	1", 2 layers	1", 2 layers	1", 2 layers
aluminum	paper	paper	aluminum	aluminum	aluminum	aluminum
foam	paper	paper				
closed, steel	steel	steel	polycarbonate	polycarbonate	polycarbonate	polycarbonate
15xØ80 mm	6xØ31 mm	8xØ40 mm	magnetically shielded	15xØ70 mm	10xØ70 mm	10xØ70 mm
145 mm	60 mm	70 mm	Ø48 mm	Ø72 mm	Ø72 mm	Ø72 mm
60 mm	16 mm	26 mm	23 mm	27 mm	24 mm	24 mm

We would like to draw your attention to our protective grid supply, shown on page 194.

DPH 1416

Dome tweeter



- P_m/P_n : 150/80 W
- f: 2.000 - 18.000 Hz
- $SPL_{1W/1m}$: 95 dB/W/m
- voice coil: 1,75", kapton
- cone: titanium
- magnet weight: 15 Oz
- weight: 2,5 kg

150W



DP 35

Ring speaker



- P_m/P_n : 150/80 W
- f: 2.000 - 20.000 Hz
- $SPL_{1W/1m}$: 103 dB
- voice coil: 1,5"
- cone: textile bakelite
- magnet weight: 15 Oz

150W



DP 10

Dome tweeter



- P_m/P_n : 150/80 W
- f: 3.000 - 20.000 Hz
- $SPL_{1W/1m}$: 106 dB
- voice coil: 1"
- cone: textile bakelite
- magnet weight: 6 Oz

150W



KHS 120

Piezo tweeter



- P_m (4 Ω): 300 W
- P_m (8 Ω): 150 W
- f: 2.000 - 20.000 Hz
- $SPL_{1W/1m}$: 92 dB
- impedance: > 1000 Ohm
- max. voltage: 35 V~

300W



KHS 110

Piezo tweeter



- P_m (4 Ω): 300 W
- P_m (8 Ω): 150 W
- f: 2.000 - 20.000 Hz
- $SPL_{1W/1m}$: 90 dB
- impedance: > 1000 Ohm
- max. voltage: 35 V~

300W



KHS 342M

Piezo tweeter



- P_m (4 Ω): 300 W
- P_m (8 Ω): 150 W
- f: 2.000 - 20.000 Hz
- $SPL_{1W/1m}$: 95 dB
- impedance: > 1000 Ohm
- max. voltage: 35 V~
- Dual piezo tweeter!

300W



KHS 311M

Piezo tweeter



- P_m (4 Ω): 300 W
- P_m (8 Ω): 150 W
- f: 2.000 - 20.000 Hz
- $SPL_{1W/1m}$: 93 dB
- impedance: > 1000 Ohm
- max. voltage: 35 V~

300W



KHS 105A

Piezo tweeter



- P_m (4 Ω): 300 W
- P_m (8 Ω): 150 W
- f: 2.000 - 20.000 Hz
- $SPL_{1W/1m}$: 94 dB
- impedance: > 1000 Ohm
- max. voltage: 35 V~

300W



KHS 106

Piezo tweeter



- P_m (4 Ω): 300 W
- P_m (8 Ω): 150 W
- f: 2.000 - 20.000 Hz
- $SPL_{1W/1m}$: 90 dB
- impedance: > 1000 Ohm
- max. voltage: 35 V~

300W



KHS 107

Piezo tweeter



- P_m (4 Ω): 300 W
- P_m (8 Ω): 150 W
- f: 5.000 - 20.000 Hz
- $SPL_{1W/1m}$: 104 dB
- impedance: > 1000 Ohm
- max. voltage: 35 V~

300W



dome and piezo tweeter

PAB 25A

Portable, active speaker cabinet, with built-in accumulator



- wireless BT connection
- listening to music from mobile devices, computer
- playing MP3 files from USB/microSD devices
- FM radio with automatic tuning
- wireless microphone with echo effect
- recording through microphone on USB/microSD device
- KARAOKE function
- built-in mixer-amplifier
- inputs: USB/microSD, BT, MIC1, MIC2, AUX
- built-in Li-ion accumulator
- automatic charging with LED indication
- option to connect 12V external accumulator
- can be placed on Ø35 mm stand, massive construction
- easy, compact, portable design
- pull-out carrying handle and castors for movements
- microphone power supply: 2xAAA (1,5V) battery, not included
- remote controller power supply: CR 2025 (3V) button cell, included
- accessories: wireless microphone, remote controller, 3,5 mm-2XRCA connection cable, +12V charging cable, network charger
- dimensions: 320 x 460 x 320 mm / 4,8 kg



PAB 20A

Portable, active speaker cabinet, with built-in accumulator

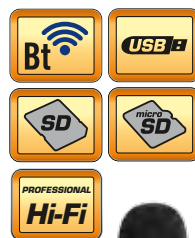

- excellent Hi-Fi sound quality
- inbuilt 3 channel mixer-amplifier
- high and low tone adjustment
- inbuilt MP3/WMA player with LCD display and remote control
- several repeat programs, random play function
- USB/SD/SDHC/MMC device connectable
- ID3 Tag text information display
- FM radio with automatic tuning and storage
- wireless BT connection
- music playing from mobile phone, PC
- inputs: USB/SD, MIC, WIRELESS MIC, LINE
- charge indicator LED
- massive design, foldable carrying handle
- 3 type of power supply: inbuilt accumulator, outer 12 V battery, mains power
- microphone power supply: 6LR61 (9V) battery (not included)
- included wireless microphone, remote control, power cable
- can be placed on a stand (option: HT 900 stand)
- dimensions: 265 x 390 x 280 mm / 8,1 kg



	PAB 25A	PAB 20A
Box	2 way, bass-reflex	2 way, bass-reflex
Pm	80 W	120 W
Pamp	60 W	80 W
Z	4 Ohm	4 Ohm
f	50-20.000 Hz	40-20.000 Hz
ØWoofer / ØCoil	10" (250 mm) / 1,5" (38 mm) / 30 Oz	8" (200 mm) / 1,5" (38 mm) / 30 Oz
Tweeter	1" (25 mm) compression / 10 Oz	1" (25 mm) compression / 10 Oz
File system	FAT16 / 32-MP3	FAT16/32-MP3, WMA
FM range	87,6-108,0 MHz	87,0-108,0 MHz
MIC range	≈50 m / <10mW	≈10 m / <10mW
MIC frequency	VHF	VHF
BT version	2.1 / 10 m max.	2.1 / 10 m max.
BT profiles	A2DP, AVRCP	A2DP, AVRCP

	PAB 25A	PAB 20A
LINE input	Ø3,5 mm	2 x RCA
MIC input	Ø6,3 mm	Ø6,3 mm
AUX input	Ø3,5 mm	-
Stand / Ø	35 mm	35 mm
Charging time	≈4 h	≈10-12 h
Operation time	≈9-10 h	≈5-7 h
Battery	Li-ion / 7,4 V / 1800 mAh	Lead-acid gel / 12 V / 5000 mAh
MIC batteries	2 x AA (1,5 V)	6LR61 (9 V)
Remote batteries	CR 2025 (3 V)	CR 2025 (3 V)
V / Hz	230 V~ / 50 Hz	230 V~ / 50 Hz
Fuse		250V / 5 A (Ø5 x 20 mm)
Ta	0 °C ... +35 °C	0 °C ... +35 °C
Dimensions / Weight	320 x 460 x 320 mm / 4,8 kg	265 x 390 x 280 mm / 8,1 kg

Active orchestral speaker cabinet with built in MP3 player

- 4in1 compact sound system
- excellent Hi-Fi sound quality
- inbuilt 3 channel mixer-amplifier
- high and low tone adjustment
- inbuilt MP3/WMA player with LCD display
- USB/SD/SDHC/MMC device connectable
- text information display
- repeating one or all tracks, random playback
- indication LED for overcontrolling
- inputs: USB/SD, AUX, MIC, LINE
- output: LINE, speakers
- stage cabinet function (can be laid on its side)
- can be placed on a stand if used for amplifying (option: HT 900 stand)
- easy-to- carry, massive construction

PAX 25PRO/A

250 W
PAX 40PRO/A

400 W

Orchestral sound cabinet

- 2 way, bass-reflex design
- excellent Hi-Fi sound quality
- high and low tone adjustment
- input: Speakon connector
- output: Speakon connector
- stage cabinet function (can be laid on its side)
- can be placed on a stand if used for amplifying (option: HT 900 stand)
- easy-to- carry, massive construction

PAX 25PRO

250 W
PAX 40PRO

400 W

	PAX 25PRO/A	PAX 40PRO/A	PAX 25PRO	PAX 40PRO
Box	2 way, bass-reflex	2 way, bass-reflex	2 way, bass-reflex	2 way, bass-reflex
P _m	220 / 150 W	400	220 / 150 W	400
Pamp	80 W + 80 W	150 W + 150 W	-	-
Z	8 Ω	8 Ω	8 Ω	8 Ω
F	45-20.000 Hz	30-22.000 Hz	45-20.000 Hz	30-22.000 Hz
Spl (W/m)	94 dB	99 dB	94 dB	98 dB
∅Woofer / ∅Coil	10" / 1,5" / 30 Oz	15" / 3" / 60 Oz	10" / 1,5" / 30 Oz	15" / 3" / 60 Oz
Tweeter	1,0" Titanium / 9 Oz	1,75" Titanium / 23 Oz	1,0" Titanium / 9 Oz	1,75" Titanium / 23 Oz
USB / SD / MP3	FAT16/32-MP3	FAT16/32-MP3, WMA	-	-
AUX INPUT	∅3,5 mm	∅3,5 mm	-	-
MIC INPUT	∅6,3 mm + XLR	∅6,3 mm + XLR	-	-
LINE INPUT	2 x RCA	2 x RCA + XLR	-	-
LINE OUTPUT	2 x RCA	∅6,3 mm	-	-
SPEAKER IN	-	-	Speakon (1 x 8 Ω)	Speakon (1 x 8 Ω)
SPEAKER OUT	Speakon (1 x 8 Ohm)	Speakon (1 x 8 Ω)	Speakon (1 x 8 Ω)	Speakon (1 x 8 Ω)
Stand ∅ / mm	35 mm	35 mm	35 mm	35 mm
V / Hz / W	230 V~ / 50 Hz / 160 W	230 V~ / 50 Hz / 400 W	-	-
Fuse	250 V~ / 3 A (∅5 x 20 mm)	-	-	-
Dimensions	32 x 50 x 26 cm	46 x 71 x 36 cm	32 x 50 x 26 cm	46 x 71 x 36 cm
Weight	8,2 kg	20 kg	7,1 kg	16 kg

PAX 225A

Active orchestral speaker cabinet with built in MP3 player

220W



- double subwoofer, double bass
- Pm/Pn: 220/150 W (4 Ohm)
- woofer: 2 x Ø250 mm paper/fabric
- piezo tweeter: 250 x 100 mm
- inbuilt mixer-amplifier
- USB-SD/SDHC/MMC stereo MP3 player
- microphone echo circuit
- treble and bass tone adjustment
- microphone input (2 x Ø6,3 mm socket)
- stereo audio input (2 x RCA sockets)
- speaker connector clips
- massive metal protective grill
- flush handles
- metal corner protectors, rubber feet
- size: 33 x 88 x 33 cm
- optional: PAX 225P speaker box

PAX 225P

Orchestral speaker cabinet

220W



- double subwoofer, double bass
- Pm/Pn: 220/150 W (4 Ohm)
- woofer: 2 x Ø250 mm paper/fabric
- piezo tweeter: 250 x 100 mm
- massive metal protective grill
- flush handles
- metal corner protectors, rubber feet
- size: 33 x 88 x 33 cm
- optional: PAX 225A speaker box



PAX 25A

Active speaker cabinet- pair, with built-in MP3 player

240W



- 1 pc active + 1 pc passive speaker box
- Pm/Pn: 2 x 120/80 W (4 Ohm)
- woofer: Ø250 mm paper/fabric
- piezo tweeter: 250 x 100 mm
- inbuilt mixer-amplifier
- USB-SD/SDHC/MMC stereo MP3 player
- microphone echo circuit
- treble and bass tone adjustment
- microphone input (2 x Ø6,3 mm socket)
- stereo audio input (2 x RCA sockets)
- speaker connector clips
- massive metal protective grill
- flush handles
- metal corner protectors, rubber feet
- size: 33 x 57 x 33 cm (x2)



PA 12

Orchestral speaker cabinet 300 W



- 2 way, bass-reflex design
- P_m/P_n: 300/200 W
- F: 30 - 20.000 Hz
- woofer: Ø300 mm/ PC cone
- tweeter: 3 x Ø100/ piezo
- massive, stable construction
- MDF wooden box, with black carpet finish
- flush carrying handle, metal protective grill
- 8 x corner protector, 4 x rubber feet
- universal connector panel: 1 x 6,3 mm socket and 2 x gilded screw connectors
- dimension: 37,5 x 53 x 33,5 cm



HT 900

Stand for orchestral speaker cabinet



- loadability: max. 40 kg
- easy, stable construction
- non-slip legs
- rod: Ø35 mm
- adjustable height: 1250 - 2050 mm
- rods: iron + aluminium
- weight: 2,3 kg



HT 901

Seath for speaker box stand



- sinks into the speaker's bottom
- allows placing the speaker box on a HT 900 stand
- suitable for every stand with Ø35 mm rod
- capacity: max. 40 kg

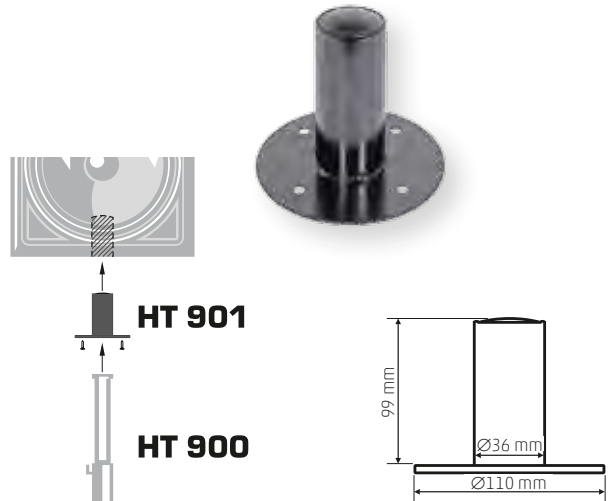

orchestral speaker cabinet, stand



MPA 250

Universal mixing amplifier

HIGH QUALITY

PROFESSIONAL

110 Volt

- multifunctional amplifier and mixer
- 3 x microphone + 3 x stereo audio input
- speakers can be connected to 6, separately switchable groups
- both for conventional and 100 V sound systems
- warning "gong" sound effect
- automatic mixdown and remixing when using the microphone
- stereo output for further amplifier connection
- treble/bass tone adjustment
- 230 V ~ / 50 Hz
- size: 430 x 90 x 390 mm

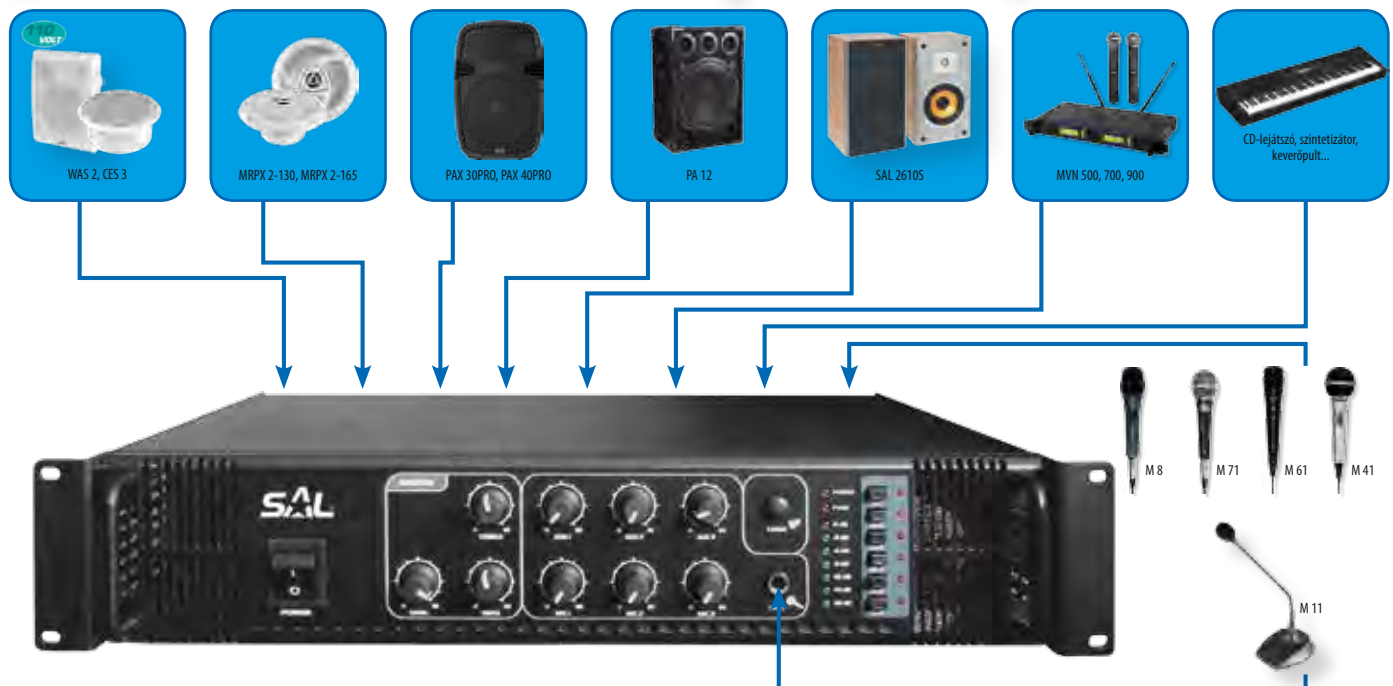

WAS 2

Wall speaker

10W

110 Volt

165 mm

- with built-in 110 V transformer
- max. loadability: 10 W
- frequency range: 50 - 18.000 Hz
- speaker: Ø165 mm
- impedance: 8 Ohm
- size: 275 x 200 x 110 mm



CES 3

Ceiling speaker

10W

110 Volt

165 mm

- with built-in 110 V transformer
- max. loadability: 10 W
- frequency range: 50 - 18.000 Hz
- speaker: Ø165 mm
- impedance: 8 Ohm
- installation size: Ø190 x 85 mm





MVN 900

Wireless microphone set



- operation range in open field: max. 100 m
- 2 professional metal hand microphones in the set
- DIVERSITY PRO: continuous analysis of reception-quality
- adjustable transmitter-output
- digital noise filtering circuit
- 110 frequencies; 10 channels selectable in 11 groups
- automatic free frequency search
- automatic channel selection
- automatic synchronization among the units
- automatic microphone searching and pairing with infra function
- manual group- and frequency selection
- high-quality, 2 channel digital DPLL operation
- multifunctional LCD displays with backlight in the grip and on the receiver unit
- display of frequency/channel/channel-group/receiving signal level/ dominant antenna/ battery status and other functions
- coloured LED-line audio modulation meter
- first class, sensitive, full sound quality
- 2x XLR & LINE OUT dual output
- high sensitivity 260mm/50 Ohm BNC antennas
- operation frequency band: 863-865 MHz (actual data on the device)
- with gift aluminium storage case
- accessory: Ø6,3mm-6,3mm audio connection cable, 1,0 m
- 2in1 AC/DC power supply option
- microphones: Ø55/40x250mm, 2 x AA (1,5 V) battery, not included
- receiver: 480/420x45x210mm, 1,5 m connection cable

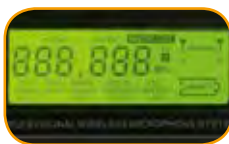

MVN 901T

Wireless backband microphone, to expand MVN 900 SET



- operation range in open field: max. 100m
- professional microphone with backband and transmitter
- 110 frequencies; 10 channels selectable in 11 groups
- automatic synchronization among the units
- automatic microphone searching and pairing with infra function
- automatic and manual group- and frequency selection
- multifunctional LCD display with backlight
- display of frequency/channel/channel-group/ signal level/ battery status and other functions
- audio modulation meter, automatic keylock
- selectable speaking- or guitar-microphone mode
- stable, flexible metal shaft and metal belt clip
- operation frequency band: 863-865 MHz
- accessory: transmitter and backband microphone included in the set
- power supply: 2 x AA (1,5V) battery, not included
- size: 65x95x25 mm / 90 g



MVN 700

Wireless microphone set

100 meters

PROFESSIONAL Hi-Fi



- 2 professional hand microphones in the set
- lockable, strong plastic storage case
- operation range in open field: max. 100m
- stable quartz-frequency technology
- interference suppression and feedback suppression electronics
- microphones are mutable without switch off
- battery-status indicator LED on the microphones
- audio signal and RF signal display on the receiver
- frequency indication on the receiver (not LCD)
- 2 x XLR & LINE OUT dual output connector
- operating frequency band: 863-865 MHz (actual data is on the device)
- accessory: Ø6,3 mm-6,3 mm audio connection cable, 1,0 m
- microphones: Ø55/40 x 250 mm, 2 x AA (1,5V) battery, not included
- receiver: 210 x 45 x 160 mm, 13,5V / 600 mA / 1,2 m adaptor, included



MVN 500

Wireless microphone set

60 meters



- 2 hand microphones in the set
- operation range in open field: max. 60m
- stable quartz-frequency technology
- interference suppression and feedback suppression electronics
- microphones are mutable without switch off
- operation display LED on the microphones
- audio signal and RF signal display on the receiver
- frequency indication on the receiver (not LCD)
- XLR & LINE OUT dual output connector
- designed for household purposes, not for professional use
- operating frequency band: 174-230 MHz (actual data is on the device)
- accessory: Ø6,3mm-6,3mm audio connection cable, 1,0 m
- microphones: Ø55/35x240mm, 2 x AA (1,5V) battery, not included
- receiver: 210 x 45 x 140mm, 220-240V/50Hz, 1,5 m power cable

MVN 10

Wireless microphone set

20 meters

FULL METAL



- wireless microphone with removable antenna and receiver unit
- wired microphone with removable connection cable
- operation range in open field: approx. 20 m
- metal handheld microphone
- operation indicator LED and on/off switch included in the grip
- cardioid polar pattern
- made for hobby purposes, not for professional use
- operation frequency band: 146-149 MHz
- accessory: Ø6,3 mm-XLR connection cable, 2,5 m
- microphone: Ø45/35x185 mm, 1xAA (1,5V) battery, not included
- receiver: 45x70 mm, 1xAA (1,5V) battery, not included



microphone set

M 8 Handheld microphone

- Ø6,3 mm
- 4,5 m cable
- ON/OFF SWITCH
- METAL XLR CONNECTION
- FULL METAL HOUSING

- dynamic microphone for professional amplifying purposes
- handy, entire metallic grip
- cardioid polar pattern
- on/off switch on the grip
- extra-long, removable XLR connection cable
- massive, metal plugs



M 71 Handheld microphone

- Ø6,3 mm
- 4,5 m cable
- ON/OFF SWITCH
- METAL XLR CONNECTION

- dynamic microphone for professional amplifying purposes
- cardioid polar pattern
- on/off switch on the grip
- extra-long, removable XLR connection cable
- massive, metal plugs



M 61 Handheld microphone

- Ø6,3 mm
- 3 m cable
- ON/OFF SWITCH
- XLR CONNECTION

- dynamic microphone for professional amplifying purposes
- cardioid polar pattern
- on/off switch on the grip
- extra-long, removable XLR connection cable



M 41 Handheld microphone

- Ø6,3 mm
- 1,8 m cable
- ON/OFF SWITCH

- dynamic microphone for professional amplifying purposes
- cardioid polar pattern
- on/off switch on the grip
- small weight, flexible connection cable



	M 8	M 71	M 61	M 41
type	dynamic	dynamic	dynamic	dynamic
polar pattern	cardioid	cardioid	cardioid	cardioid
frequency range	45 - 19.000 Hz	50 - 18.500 Hz	80 - 14.500 Hz	100 - 12.500 Hz
sensitivity	-56 dB	-55 dB	-52 dB	-46 dB
impedance	600 Ohm	600 Ohm	600 Ohm	600 Ohm
output plug	XLR / Ø6,3 mm	XLR / Ø6,3 mm	XLR / Ø6,3 mm	Ø6,3 mm
cable length	~ 4,5 m	~ 4,5 m	~ 3 m	~ 1,8 m
t ₀	0 - 45 °C	0 - 45 °C	0 - 45 °C	0 - 45 °C
size	Ø50 / 40 x 180 mm	Ø55 / 37 x 180 mm	Ø42 / 31 x 170 mm	Ø53 / 31 x 170 mm
weight	300 g	180 g	130 g	60 g

M 11 Desk microphone

- 5m cable
- ON-OFF LED

- professional electret-condenser microphone
- usable for devices provided with microphone-input
- LED indicator on the base
- LED indicator ring on the shaft
- built-in on/off switch in the base
- removable noise-filter sponge
- cardioid polar pattern
- massive, metal XLR connection plug
- extra-long, removable connection cable (5 m)
- accessories: Ø6,3 mm-XLR audio connection cable, noise-filter sponge
- dual power supply: battery or +48 V phantom power
- battery type: 6LR61 (9 V) battery, not included
- dimensions: 125 x 150 x 490 mm / 610 g



HT 801 Microphone clamp

- PROFESSIONAL
- UNIVERSAL

- clip for all types of microphones
- accessory Ø15/9 mm screw transformer
- ideal for HT 800 stand, but can be used for other types as well



BTHP 3000

BT headphone with microphone



- 5in1: BT/MP3/FM/microphone/wired mode
- crystal clear HiFi stereo sound
- wireless BT connection
- listening to music through mobile device or computer
- music player application control
- built-in sensitive microphone
- telephone conversation without touching the phone
- receiving-, rejecting calls, dialling
- for computer chat or multiplayer games
- playing MP3 files from microSD card
- FM radio with automatic tuning
- wired and wireless mode
- voice announcement by shifting operation modes
- built-in Li-Po accumulator
- accessories: USB-miniUSB charging cable and 3,5 mm connection cable, 1 m



BTHP 2000/BK

BT headphone with microphone



- crystal clear HiFi stereo sound
- light, comfortable, backband design
- small size, foldable
- ideal at home, on the streets, or for sports
- wireless BT connection
- listening to music through mobile device or computer
- stepping tracks, remote control
- telephone conversation without touching the phone
- receiving-, rejecting calls, redialling
- for computer chat or multiplayer games
- automatic reconnection
- automatic switch off
- extremely long (up to 25 hours) operating time
- inbuilt sensitive microphone
- inbuilt Li-Po secondary battery
- USB-miniUSB charging cable (included)
- speakers: 2 x 40 mm, 32 Ohm
- accumulator: Li-Po/ 3,7 V - 400 mAh
- charging time: cca. 3 hours
- operation time: 25 hours
- voice announcement by shifting operation modes
- built-in Li-Po accumulator
- accessories: USB-miniUSB charging cable and 3,5 mm connection cable, 1m



HPM 1

Multimedia headphone with volume control

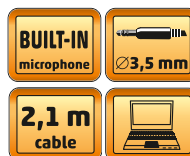

- stereo multimedia headphone with microphone
- ideal for multimedia systems
- volume control
- frequency range: 20 - 20.000 Hz
- impedance: 32 Ohm



EPM 1

Stereo earphone with microphone

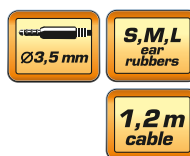

- ideal for mobile phones and computers
- button for answering calls/rejecting calls/redialling
- volume control
- 3 pairs of rubber plug, 3 sizes
- Ø3,5 mm plug, 1,2 m connection cable
- frequency range: 20 - 20.000 Hz
- impedance: 16 Ohm
- sensitivity: 95 dB/mW
- power: 10 mW
- speaker: Ø9 mm

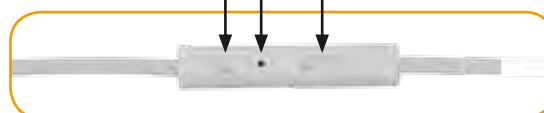

BT version	CSR 4.0 / EDR CLASS2
BT profiles	2.1 / A2DP, V1.2, AVRCP, V1.4 / 10 m A2DP, AVRCP, headphone
Speakers	2 x 40 mm, 32 Ohm
Frequency range	18 - 22.000 Hz
SPL	108 dB
Accumulator	Li-Po / 3,7 V - 400 mAh
Charging time	cca. 3 hours
Operation time	up to 25 hours

HPH 38 Stereo headphone

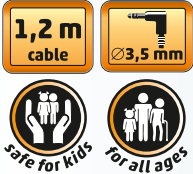

- SAFE TO USE FOR YOUNG AND OLD!
 DESIGN THAT LIMITS HARMFULLY LOUD VOLUMES!
- safe and fashionable solution for all ages
 - complies with standard EN 50332-2 to limit volume
 - protect the hearing of children and adults, limits the volume above the harmful level
 - first rate quality, extremely durable
 - ultra-light and robust
 - flexible, hard to break headband, cannot injure the child
 - big size, hypoallergenic ear pads
 - perfectly comfortable, suitable to wear all day long
 - ideal for education and professional use
 - practical, pipe-shape connection plug
 - Ø3,5 mm plug, 1,2 m connection cable
 - frequency range: 20 - 20.000 Hz
 - impedance: 32 Ohm



HPH 98 Stereo headphone

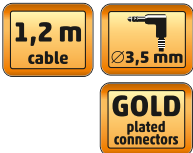

- recommended for professional use: conference/ interpreting/ tour guides
- ideal for listening to music at home or by mobile devices
- indispensable tool for conference translators
- space-saving storing and carrying: foldable speakerphones
- comfortable wearing, cable output on one side
- practical, pipe-shape connection plug
- replaceable sponge separately available (HPH 98SP)
- Ø3,5 mm plug, 1,2 m connection cable
- frequency range: 20 - 20.000 Hz
- impedance: 32 Ohm



CONFERENCE • INTERPRETER • TOUR GUIDE



HPH 98SP

Spare sponge pair for HPH 98 headphone



- recommended for professional users
- economic and hygienic solution, if the original sponge is worn out, or the headphone is worn by different people
- size: 50 x 60 mm

HPH 7

Stereo headphone



- comfortable, padded design
- with volume control
- frequency range: 20 - 22.000 Hz
- impedance: 32 Ohm
- sensitivity: 105 dB ± 2 dB / mW
- output: 30 mW
- speaker: Ø40 mm



HPH 3 Stereo headphone



- rotary speakers
- stereo/mono transformer include
- frequency range: 20 - 20.000 Hz
- impedance: 32 Ohm

HPH 2 Stereo headphone



- extra light weight (35 g)
- frequency range: 20 - 20.000 Hz
- impedance: 32 Ohm

HPH 1 Stereo headphone



- extra light weight (45 g)
- frequency range: 20 - 20.000 Hz
- impedance: 32 Ohm



HPH 6/BK

Stereo headphone

1,2 m
cable



GOLD
plated
connectors

- rotary speakers
- frequency range: 20 - 22.000 Hz
- impedance: 32 Ohm
- sensitivity: 100 dB ± 3 dB/mW
- output: 50 mW
- speaker: Ø30 mm



HPH 6/WH

HPH 5/BL

Stereo headphone

2 m
cable



- folding desing
- frequency range: 20 - 22.000 Hz
- impedance: 32 Ohm
- sensitivity: 105 dB ± 2 dB/mW
- output: 30 mW
- speaker: Ø40 mm



HPH 5/P

EP 8/BL

Stereo earphone with ear rubber

1,2 m
cable



S,M,L
ear
rubbers

- frequency range: 20 - 20.000 Hz
- impedance: 16 Ohm
- sensitivity: 95 dB/mW
- output: 10 mW
- speaker: Ø9 mm



EP 8/P

Stereo earphone with ear rubber

1,2 m
cable



S,M,L
ear
rubbers

- frequency range: 20 - 20.000 Hz
- impedance: 16 Ohm
- sensitivity: 95 dB/mW
- output: 10 mW
- speaker: Ø9 mm

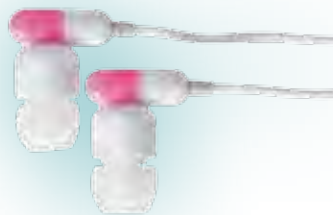

EP 10

Stereo earphone with ear rubber

1,2 m
cable



- ergonomic design
- comfortable wearing, excellent sound
- frequency range: 20 - 20.000 Hz
- impedance: 16 Ohm

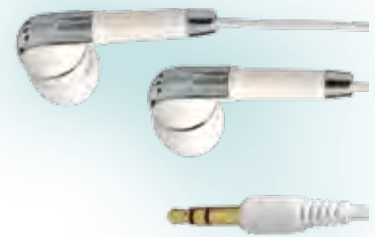

EP 2

Stereo earphone

1,2 m
cable



- ergonomic design
- comfortable wearing, excellent sound
- frequency range: 20 - 20.000 Hz
- impedance: 32 Ohm



EP 1

Stereo earphone

1,2 m
cable



- ergonomic design
- comfortable wearing, excellent sound
- frequency range: 20 - 20.000 Hz
- impedance: 32 Ohm



OH 1

Mono earphone

0,9 m
cable



- impedance: 8 Ohm
- mono

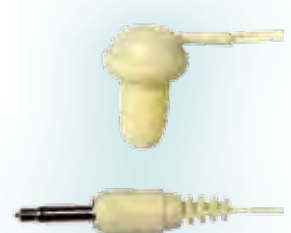

KLS, KL

1

KLS ...T

2

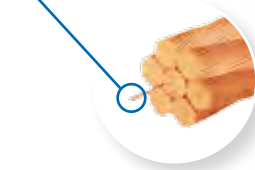
 KLS series - Ø0,15 mm fiber
copper clad aluminum

3

KL ...T

4

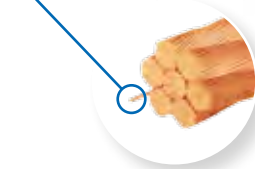
 KL series - Ø0,10 mm fiber
oxygen free copper

pict.	type	denomination, features	length
1	KLS 0,15	2 x 0,15 mm ² red-black speaker cable, 2C x (9 x 0,15 mm), width x height: 3,6 x 1,8 mm, from 0,15 mm fiber	100 m/coil
1	KLS 0,35	2 x 0,35 mm ² red-black speaker cable, 2C x (20 x 0,15 mm), width x height: 4,0 x 2,0 mm, from 0,15 mm fiber	100 m/coil
1	KLS 0,5	2 x 0,5 mm ² red-black speaker cable, 2C x (29 x 0,15 mm), width x height: 4,4 x 2,2 mm, from 0,15 mm fiber	100 m/coil
1	KLS 0,75	2 x 0,75 mm ² red-black speaker cable, 2C x (43 x 0,15 mm), width x height: 4,6 x 2,3 mm, from 0,15 mm fiber	100 m/coil
1	KLS 1	2 x 1,0 mm ² red-black speaker cable, 2C x (57 x 0,15 mm), width x height: 5,6 x 2,8 mm, from 0,15 mm fiber	100 m/coil
1	KLS 1,5	2 x 1,5 mm ² red-black speaker cable, 2C x (85 x 0,15 mm), width x height: 6,0 x 3,0 mm, from 0,15 mm fiber	100 m/coil
2	KLS 0,5T	2 x 0,5 mm ² transparent speaker cable, 2C x (29 x 0,15 mm), width x height: 4,4 x 2,2 mm, from 0,15 mm fiber	100 m/coil
2	KLS 0,75T	2 x 0,75 mm ² transparent speaker cable, 2C x (43 x 0,15 mm), width x height: 4,6 x 2,3 mm, from 0,15 mm fiber	100 m/coil
2	KLS 1T	2 x 1,0 mm ² transparent speaker cable, 2C x (57 x 0,15 mm), width x height: 5,6 x 2,8 mm, from 0,15 mm fiber	100 m/coil
2	KLS 1,5T	2 x 1,5 mm ² transparent speaker cable, 2C x (85 x 0,15 mm), width x height: 6,0 x 3,0 mm, from 0,15 mm fiber	100 m/coil
2	KLS 2,5T	2 x 2,5 mm ² transparent speaker cable, 2C x (7 x 21 x 0,15 mm), width x height: 7,6 x 3,8 mm, from 0,15 mm fiber	50 m/coil
2	KLS 4T	2 x 4,0 mm ² transparent speaker cable, 2C x (7 x 33 x 0,15 mm), width x height: 8,8 x 4,4 mm, from 0,15 mm fiber	50 m/coil
2	KLS 6T	2 x 6,0 mm ² transparent speaker cable, 2C x (7 x 49 x 0,15 mm), width x height: 12,0 x 6,0 mm, from 0,15 mm fiber	25 m/coil
3	KL 0,15	2 x 0,15 mm ² red-black speaker cable, 2C x (19 x 0,10 mm), width x height: 3,6 x 1,8 mm, from 0,1 mm fiber	100 m/coil
3	KL 0,35	2 x 0,35 mm ² red-black speaker cable, 2C x (45 x 0,10 mm), width x height: 4,0 x 2,0 mm, from 0,1 mm fiber	100 m/coil
3	KL 0,5	2 x 0,5 mm ² red-black speaker cable, 2C x (64 x 0,10 mm), width x height: 4,4 x 2,2 mm, from 0,1 mm fiber	100 m/coil
3	KL 0,75	2 x 0,75 mm ² red-black speaker cable, 2C x (96 x 0,10 mm), width x height: 4,6 x 2,3 mm, from 0,1 mm fiber	100 m/coil
3	KL 1	2 x 1,0 mm ² red-black speaker cable, 2C x (127 x 0,10 mm), width x height: 5,6 x 2,8 mm, from 0,1 mm fiber	100 m/coil
3	KL 1,5	2 x 1,5 mm ² red-black speaker cable, 2C x (7 x 27 x 0,10 mm), width x height: 6,0 x 3,0 mm, from 0,1 mm fiber	100 m/coil
4	KL 0,5T	2 x 0,5 mm ² transparent speaker cable, 2C x (64 x 0,10 mm), width x height: 4,4 x 2,2 mm, from 0,1 mm fiber	100 m/coil
4	KL 0,75T	2 x 0,75 mm ² transparent speaker cable, 2C x (96 x 0,10 mm), width x height: 4,6 x 2,3 mm, from 0,1 mm fiber	100 m/coil
4	KL 1T	2 x 1,0 mm ² transparent speaker cable, 2C x (127 x 0,10 mm), width x height: 5,6 x 2,8 mm, from 0,1 mm fiber	100 m/coil
4	KL 1,5T	2 x 1,5 mm ² transparent speaker cable, 2C x (7 x 27 x 0,10 mm), width x height: 6,0 x 3,0 mm, from 0,1 mm fiber	100 m/coil
4	KL 2,5T	2 x 2,5 mm ² transparent speaker cable, 2C x (7 x 45 x 0,10 mm), width x height: 7,6 x 3,8 mm, from 0,1 mm fiber	50 m/coil

HV 228

Crossover

200 W

↑↑
2 WAY

8 Ω

f_{28}
+120
-95

- loadability: max. 200W
- crossover frequency: 3.000 Hz
- crossover filter: 12 dB/octave
- switchable output level, high: 0/-3 dB



HV 328

Crossover

200 W

↑↑↑
3 WAY

8 Ω

f_{30}
+160
-137

- loadability: max. 200W
- crossover frequency: 500 Hz/ 3.000 Hz
- crossover filter: 12 dB/octave
- switchable output level, high: 0/-3 dB, medium: 0/-2 dB



HV 316A

Crossover

100 W

↑↑↑
3 WAY

8 Ω

f_{35}
+85
-95

- loadability: max. 100W
- crossover frequency: 900 Hz/ 4.000 Hz
- crossover filter: 12 dB/octave



HV 211A

Crossover

100 W

↑↑
2 WAY

8 Ω

f_{27}
+100
-60

- loadability: max. 100W
- crossover frequency: 3.300 Hz
- crossover filter: 12 dB/octave



HVS 14 / 8 Ohm

Crossover

300 W

8 Ω

↑
1 WAY

f_{45}
+90
-70

- max. 300 W
- crossover frequency: 160 Hz
- crossover filter: 12 dB/octave
- for subwoofers

SUITABLE FOR USE WITH 4 AND 8 Ω SYSTEMS AS WELL!



HVS 14 / 4 Ohm

Crossover

300 W

4 Ω

↑
1 WAY

f_{45}
+90
-70

- max. 300 W
- crossover frequency: 120 Hz
- crossover filter: 12 dB/octave
- for subwoofers

SUITABLE FOR USE WITH 4 AND 8 Ω SYSTEMS AS WELL!



SL 5 Speaker plug

- 2 pins
- sprung
- screwable
- with strain relief



SPK 900 Speakon plug

- 4 poles
- screwable
- with strain relief



SPK 850 Speakon socket

- 4 poles
- can be built-in
- with terminal
- 30 x 25 mm



SPK 860 Speakon socket

- 4 poles
- can be built-in
- with terminal
- Ø50 mm



S 23 Microphone plug

- 3 poles
- swings



S 24 Microphone socket

- 3 poles
- swings



S 25K Microphone socket

- 3 poles
- to be built-in



SL 106 Speaker box connector

GOLD

- 2 poles
- with 2 pcs gilded metal banana-connector



external size:
94 x 80 mm

SL 6MG Speaker box connector

GOLD

- with 2 pcs gilded metal banana-connector



external size:
Ø105 mm

SL 5ER Speaker box connector

- 2 poles
- spring mechanism



external size:
Ø75 mm

SL 4ER Speaker box connector

- 4 poles
- spring mechanism



external size:
70 x 24 mm

SL 2ER Speaker box connector

- 2 poles
- spring mechanism



external size:
52 x 22 mm

KAH 303

Reflex tube

- adjustable length
- $\varnothing 66 \times 125 - 250$ mm
- 2 pcs/package

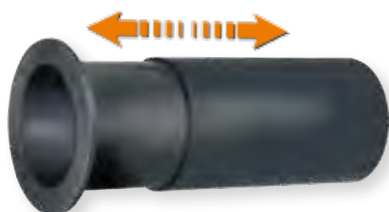

KAH 202

Reflex tube

- can be cut to proper size
- $\varnothing 45 \times 100$ mm
- 4 pcs/package



HT 203

Recessed handle for speaker cabinet

- metal
- $220 \times 163 \times 60$ mm



HT 201

Recessed handle for speaker cabinet

- plastic
- $130 \times 80 \times 80$ mm

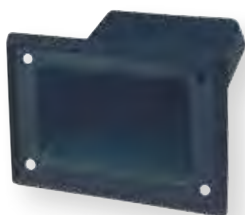

HT 200

Speaker cabinet carrying handle

- metal + rubber
- 250 mm



HT 410

Speaker cabinet corner

- metal
- $40 \times 40 \times 40$ mm



HT 402

Speaker cabinet corner

- plastic
- $54 \times 54 \times 81$ mm



HT 401

Speaker cabinet corner

- plastic
- $37 \times 37 \times 55$ mm



HT 400

Speaker cabinet corner

- plastic
- $40 \times 40 \times 40$ mm



HT 304

Fixing clip

- for G type speaker grills
- 8 pcs/ package



HT 305

Fixing clip

- for G type speaker grills
- 8 pcs/ package



HT 601

Fastener pin and sleeve for detachable cover grid

- plastic pin + rubber sleeve for the detachable cover grid of speaker boxes
- hole needed: $\varnothing 6 / \varnothing 9$ mm
- 8 pcs/ package

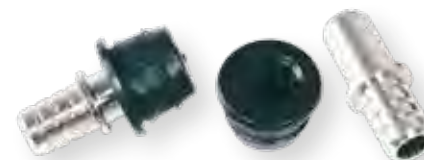

HT 600

Fastener pin and sleeve for detachable cover grid

- ball stud + plastic sleeve for the detachable cover grid of speaker boxes
- hole needed: $\varnothing 10 / \varnothing 14$ mm
- 12 pcs/ package



HT 3123

Rubber leg for speaker cabinet

- $\varnothing 37 \times 16$ mm
- can be fastened with $\varnothing 5$ mm screw
- hard, massive rubber
- built-in metal washer
- 4 pcs/ package



HT 510

Speaker mounting screw

- black
- M5 x 28 mm
- with $\varnothing 16 \times 8$ mm clawed nut
- 8 pcs/ package



G, SG SERIES

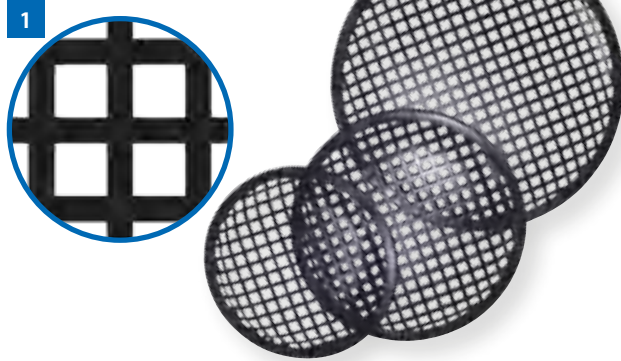

denomination	photo	type	size (Ø)	speaker (Ø)	features
Speaker grill for woofers and subwoofers (car HiFi, home Hi-Fi and amplifying)	1.	G 16	169 mm	165 mm	G series can be fixed with HT 304 and HT 305 type clips. 1 pc/package
		G 20	203 mm	200 mm	
		G 25	255 mm	250 mm	
		G 30	306 mm	300 mm	
		G 40	385 mm	400 mm	
Cone edge	2.	SG 13	130 mm	130 mm	For replacement of old, torn edges. For repairing and renewal of old speakers. Ideal for all types of Ø130, Ø165, Ø200, Ø250, Ø300 mm speakers and VIDEOTON types as well.
		SG 16	165 mm	165 mm	
		SG 20	200 mm	200 mm	
		SG 25	250 mm	250 mm	
		SG 30	300 mm	300 mm	

Check the applicability of protective grilles because of different baskets design of speakers!

SA-HSZBGY 008 Speaker ring



- 2 x Ø165 mm, for front and rear speakers
- Audi, Seat, Volkswagen
- A2
- Seat Leon 2000. 01 →
- Seat Toledo 1999. 01 →
- Volkswagen Passat¹⁺² 1996. 07 →
- Volkswagen Passat Variant¹⁺², 1997. 06 →
- Volkswagen Golf IV¹⁺², 1997. 09 → 1998. 10
- Volkswagen Bora¹⁺², Volkswagen Golf V²

SA-HSZBGY 004 Speaker ring



- 2 x Ø165 mm, for front speakers
- Opel
- Astra F 1991. 01 → 1998. 02
- Astra 1998. 03 →
- Omega B 1994. 05 →
- Vectra B 1995. 10 →
- Zafira 1999. 01 →

Fabric for sound attenuation

- essential for building new speakers
- easy to cut, open cell structure
- homogeneous, flexible, water vapor permeable
- 100% fibers
- white



HT 35

- thickness 25 ± 5 mm, 30 x 75 cm

HT 35/30M

- thickness 25 ± 5 mm, width: 2,0 m, length: 30 m

Sound absorption sponge

- ideal for HIGH-END quality speaker cabinets
- clear bass and midrange sound
- easy to cut to proper size
- stable structure
- self-supported
- dark grey

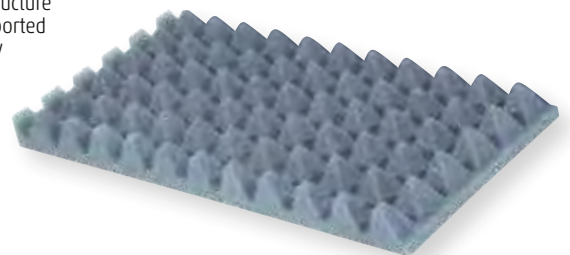

HT 2340

- thickness 30 mm, 30 x 60 cm

HT 2340/2

- thickness 30 mm, 80 x 80 cm

Speaker cover fabric

- easy to cut and stick
- for speaker cabinets exposed to surface damages
- grey/black
- 70 x 140 cm



HT 70/GR

- grey

HT 70/BK

- black

Car accessories

Operate your favourite network devices in your car, listen to your radio with real sensitive antenna! In our accessory range, you can find automotive electrical and sound technology connectors, car care products, phone and tablet holders to be fixed on dashboard.

Voltage converter

- provide supply voltage, if 12 V is available
- 12 V \rightarrow 230 V ~ (50 Hz) inverter
- useful on trips, during travelling...
- can be used in a vehicle, ship, camping
- overload protection
- overheat protection
- short circuit protection
- accumulator depletion protection
- child safety in mains socket

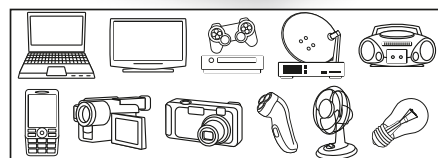

SAI 600W

- 300 W continuous load capacity
- 600 W peak load capacity

600 W

SAI 1000W

- 500 W continuous load capacity
- 1000 W peak load capacity

1000 W

SAIP 300W

Voltage converter



- provide supply voltage, if 12 V is available
- 12 V \rightarrow 230 V ~ (50 Hz) inverter
- equipped with USB socket for mobile devices, max. 1000 mA
- can be placed to the glass holder of the vehicle
- overload protection
- overheat protection
- short circuit protection
- accumulator depletion protection
- child safety in mains socket

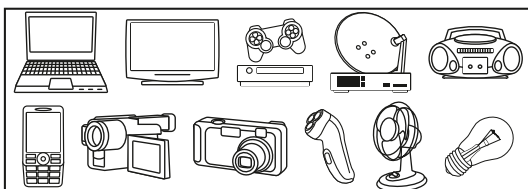

SMC 33

Battery charger

	low-current charging	12V / 0,8 A (14,4 Vmax.)
	high current charging	12V / 3,3 A (14,4 Vmax.)
	winter charging mode	12V / 3,3 A (14,7 Vmax.)
	recovery program	12V / 0,2 A (20 Vmax.)
	two-stage charging	continuous Amper/Volt
	maintenance charge	impulse 10-60 mA

- for conventional lead-acid batteries and maintenance-free gel or glass fiber types
- for car and motorcycle batteries: 2-90 Ah / 12 V
- 6 automatic, professional filling program
- high technology pulse charging
- longer battery life
- renovating the old batteries
- reverse polarity protection
- protection against short-circuit
- protection against overheating
- size: 125 x 39 x 65 mm



90571

Starter cable

- max. 600 A / 12-24 V
- 4,0 m / 6,00 mm²
- 99 % quality copper
- in carrying bag



90533

- max. 400 A / 12-24 V
- 2,5 m / 5,00 mm²

90519

- max. 200 A / 12-24 V
- 2,5 m / 3,00 mm²

SA 022

Distributor for cigarette lighter

- for operation of 2 devices at the same time
- LED indicator
- input: 12 V $\overline{\text{DC}}$
- output: 2 x 12 V $\overline{\text{DC}}$ / max. 5 A



SA 023

Distributor for cigarette lighter

- for operation of 4 devices at the same time
- LED indicator, 70 cm cable
- can be stuck with double-sided adhesive tape
- input: 12 V $\overline{\text{DC}}$
- output: 3 x 12 V $\overline{\text{DC}}$ /max. 5 A
- USB output: 5 V/max. 500 mA



94838

Extending cable for cigarette lighter

- spiral wire
- red LED indicator light
- 12-24 V $\overline{\text{DC}}$
- 10 A fuse
- length: approx. 4 m



91998

Cigarette lighter plug

- with fuse holder and F 8A ($\varnothing 5 \times 20$ mm) fuse
- with built-in lighting toggle switch
- 12-24 V use, to be soldered
- switches on or off and protect your devices



WS 11

Cigarette lighter socket

- ideal for extending cables
- suitable for car vacuum-cleaner, cooler-box
- 12 V $\overline{\text{DC}}$



WS 20

Cigarette lighter plug

- with fuse holder and F 3A ($\varnothing 6 \times 30$ mm) fuse
- 12 V $\overline{\text{DC}}$



SA 045

Car USB charger

3,1 A



- for quick charging of the accumulator of portable devices
- especially recommended for devices with big current consumption
- usable in vehicles with 12- 24 V power
- operation indicator blue LED light
- overvoltage-, overloading- and short circuit protection
- extra USB connection cable is needed
- input: 12 - 24 V $\overline{\text{DC}}$
- output: 3 x USB 5 V $\overline{\text{DC}}$ / $\Sigma 3,1$ A $_{\text{max}}$



SA 034

Car USB charger

2,1 A



- for quick charging of the accumulator of portable devices
- especially recommended for devices with big current consumption (navigation, smartphones, tablet, PC...)
- usable in vehicles with 12- 24 V power
- extra USB connection cable is needed
- input: 12 - 24 V $\overline{\text{DC}}$
- output: 5 V $\overline{\text{DC}}$ / max. 2100 mA



SA 020

Car USB charger

1,0 A



- for quick charging of the accumulator of portable devices
- ideal for music player, navigation, mobile phones...
- usable in vehicles with 12- 24 V power
- extra USB connection cable is needed
- input: 12 - 24 V $\overline{\text{DC}}$
- output: 5 V $\overline{\text{DC}}$ / max. 1000 mA



SA 032

Car microUSB charger, can be wound up

800 mA

- usable in vehicles with 12 V power
- microUSB-B plug, on c.a. 90 cm cable
- automatic winding up
- input: 12 V $\overline{\text{DC}}$
- output: 5 V $\overline{\text{DC}}$ / max. 0,8 A



distributor for cigarette lighter, connector, car USB charger



SA-ANTCS 008 Car antenna adapter

- DIN
- phantom supply



SA-ANTCS 004 Car antenna extension

- DIN socket - DIN plug
- 1,0 m



SA-ANTCS 001 Car antenna adapter

- ISO plug to DIN plug



SA-ANTCS 002 Car antenna adapter

- DIN plug to ISO plug



SA-ANTCS 014 Car antenna adapter

- DIN plug to ISO plug
- strengthened product



Car antennas in various design, for all vehicle brands, fitting to all places for installation. Some antennas are with built-in amplifier!
Separately available antenna shafts for replacement of damaged ones.

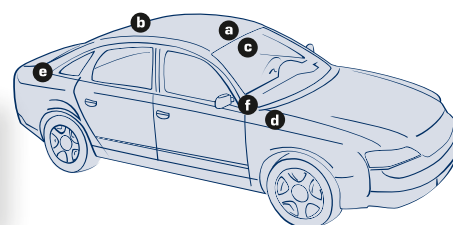
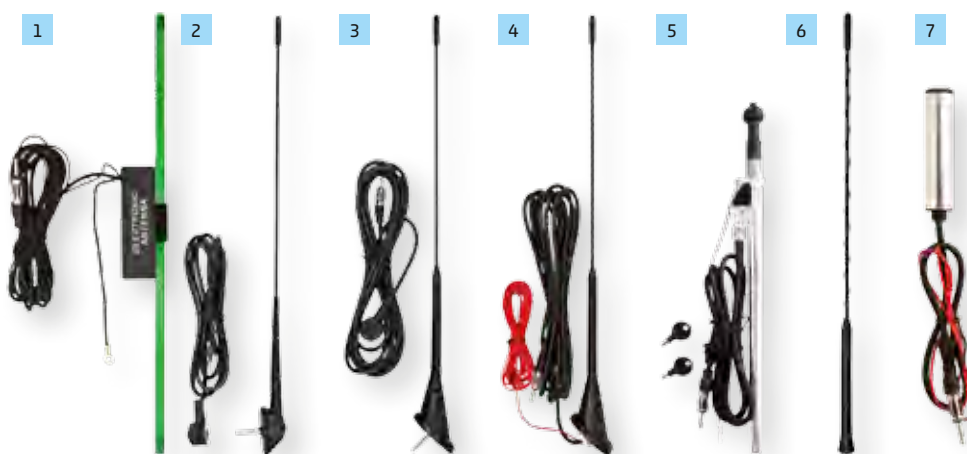

pict.	type	denomination	technical parameters	location on the vehicle
1	91110	Car antenna with amplifier	inner antenna, can be stuck to the windshield, with adhesive fixing, with built-in amplifier (12 V), 340 x 9 mm stripe, DIN connector and plug, 1,9 m cable	c
2	90557	Car antenna to the top	drop-shape base, Ø5 mm screw, 440 mm/ tiltable 0 -45°, rubber coated, DIN plug, 2 m cable	a
3	90595	Car antenna to the top	oval base (VW Golf), Ø5 mm screw, 400 mm/ 52 ° fixed tilt-angle, rubber coated, DIN plug, 3 m cable	b
4	93220	Car antenna with amplifier to the top	oval base (VW Golf), Ø5 mm screw, with built in amplifier (12V), 400 mm/ 52 ° fixed tilt-angle, rubber coated, DIN plug, 3 m cable	b
5	94586	Car antenna, retractable	primarily recommended for Opel Astra type, can be recessed to the fender plate, telescopic, can be locked with key (2 pcs), adjustable length: 30 - 115 cm, installation depth: 245 mm, DIN plug, 2 m cable	e
6	90618	Antenna shaft	for replacement of damaged or lost shafts, 400 mm, rubber coated, screw: Ø5 mm	a, b, d, e, f
7	94531	Antenna amplifier	AM/FM: 18/14 dB, DIN socket and DIN plug to be connected between the antenna and car radio, 40 cm long connector cables, power supply: 12 V---	

Make sure about the compatibility of the selected type before buying!

SA-FISO 031

ISO speaker connector socket

- only for speakers
- with 15 cm long, labelled wire



SA-FISO 032

ISO power supply socket

- only for providing supply
- with 15 cm long, labelled wire



SA-FISO 028

ISO speaker connector plug

- only for speakers
- with 15 cm long, labelled wire



SA-FISO 027

Universal power adapter ISO

- only for providing supply
- with 15 cm long, labelled wire



ISO 2

ISO connector pair for car radio

- for connecting speakers and power supply
- with 15 cm long, labelled wire



SA-FISO 022

Radio connection cable (ISO plug extension)

- extension
- ISO plug - ISO socket pair
- power supply/4 speakers



90212

Built-in cigarette lighter socket

- ideal for the appliances of the passengers in the back seats
- suitable for the power supply of the equipment placed in the tank
- porcelain inlay
- needs 24 mm hole
- Voltage: 12 V^{DC}



90762

Trailer swivel connector

- 7 poles, cable strain relief
- Voltage: 12 V^{DC}



90779

Trailer connector socket

- 7 poles, with spring protective lid
- Ø70 mm
- Voltage: 12 V^{DC}



**SS 1116/N
SS 1116/P**

Car battery connector

GOLD

- for positive pole (P)
- for negative pole (N)
- output: 2 x 10 mm² + M8 screw with Ø16 mm washer
- titanium, with gold plated screw



SS 1-4317/G

AGU fuse holder

GOLD

- connection cable: 20/10 mm²
- removable wire reducer ring
- for Ø10 x 38 mm AGU fuses
- triple rubber insulation
- waterproof design
- transparent housing, gold plated



**SS 30A, 40A,
60A, 80A**

AGU fuse

GOLD

- Ø10,3 x 38 mm
- 30 A / 40 A / 60 A / 80 A
- gilded



SA 057

Parking assistant, with laser

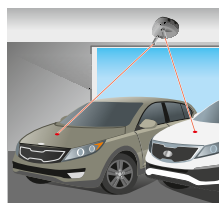

- helps precise parking even for two cars
- automatic switch ON, PIR motion sensor
- power supply in case of power cut: alkaline 6LR61 (9 V) battery, not included
- screws and studs included
- power supply: 230 V~ / 50 Hz / 9 V= / 300 mA



90717

Foot pump with 3 valves

- with 1+2 valve adapter
- air pressure measuring up to 7 bar
- application fields: car-, motor-, bicycle tire; rubber boat, air mattress, balls...



91769

Air pressure measurer for tires

- durable, massive, metal housing
- measuring range: 0,5-7,5 bar



90786

Car compressor

- air pressure: max. 18 bar, 250 PSI
- motor current consumption: 10 A
- 4 pcs nozzle adapter
- cable length: 3 m
- power supply: 12 V= or 230 V~



90304

Car compressor

- air pressure: max. 18 bar, 250 PSI
- motor current consumption: 10 A
- 3 pcs nozzle adapter
- cable length: 2,5 m
- power supply: 12 V=



93848

Package fixing straps

- 5 meter / 25 x 2 mm
- capacity: max. 500 kg
- ratchet tensioner for fixing



90410

Rubber rope

- 2 x 80 cm, Ø8 mm
- with 4 pcs steel hooks



90458

Rubber rope

- 4 x 60 cm, Ø8 mm
- with 8 pcs steel hooks



SA 053 Universal, dual suction cup holder

- for fixation of telephone, tablet, navigation, monitor...
- can be practically rotated in 2 x 360 degrees
- dimensions of the device don't influence usability
- it can be fixed on rough surfaces (e.g.: dashboard) with the included suction rings



SA 037 Universal gel suction cup holder

- extremely dependable fixation
- world newest, practical easy solution
- easier usage, than previous models
- device can be installed with only one hand
- can be used for 30-95 mm wide appliances
- rotatable 360 degrees, and can be tilted
- with new, strengthened, gel suction cup



SA 038 Universal car holder and charger set

- mobile device holder and quick charger
- microUSB charging cable included
- flexible adjustment, meets all requirements
- usable for holding devices up to 100 mm width
- flexible shaft and 360° rotatable head
- it doesn't disturb forward view, not windshield mountable



SA 052 Universal tablet holder with suction cups

- professional fixation for portable, 7 - 10,1" devices
- ideal for fixation of tablets, e-book readers, monitors, navigations
- in cars: on the headrest or windshield
- at home: on table, shelf, furniture



SA 024 Universal holder for car, with suction cups

- professional fixation for portable devices
- location modes: on windshield, dashboard or air ventilation openings
- flexible adjustment, meets all requirements

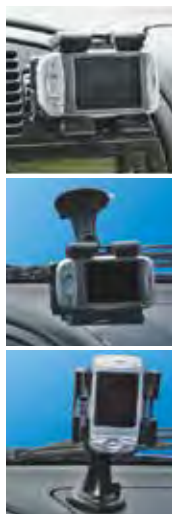

SA 047 Universal holder for car, with suction cups

- dependable fixation for portable devices
- it can be installed even with one hand only
- can be used for 50-90 mm wide appliances



SA 025 Anti slip pad

- safe fixation of objects on the dashboard of vehicles
- made of adherent gel material which is sticking without glue and magnet
- can be relocated at any time, durable
- usable on all solid surfaces
- use warm water and detergents for cleaning
- size: 80 x 135 mm



SA 058 Anti slip pad

- made of adherent gel material which is sticking without glue and magnet
- make the place for the non-slip pad free of dust and grease
- do not use silicone for this surface!
- it is recommended to remove and clean it once a week!
- use warm water and detergents for cleaning
- never place on or near air bags
- do not leave it in the car in case of direct strong sunlight or frost
- size: 155 x 100 x 20 mm



SA 055 Table mobile holder

- ideal for location of mobile phones, tablets, E-book readers
- holds devices stable if they are laid or set
- its soft surface doesn't scratch the appliances
- foldable, easy to carry
- size - folded: 31 x 112 x 8 mm
- 12 pcs / display





Connectors for mobile devices

Nowadays, it seems inconceivable to live without mobile devices: mobile phones, tablets, laptops, navigation systems, multimedia devices etc.

It is important to be always available, everywhere and in all circumstances and also to abreast the latest news immediately.

You can find charging cables fitted with different types of connectors, adapters, traditional and more powerful fast chargers in our range of products.

USB A/MICRO-1 Charging cable, micro USB

- length: 1 m

2,1 A

USB B
UNIVERSAL SERIAL BUS

- USB-A plug - microUSB-B plug
- good thermal conductivity, massive metal plugs
- protects the warming mobile device, conducts a part of the heat
- both plugs can be connected inversely, without checking the position of the socket
- easy and fast use even in poor visibility conditions (eg. at night, on the side or back of devices, or in sockets in cars)
- demanding, flexible, nylon woven wire
- overcoat and plugs are well resistant to physical effects
- exclusive design and quality
- usually can be used as data cable as well
- USB 2.0 / 5 V $\overline{\text{---}}$ / 2.1 A

USB A/MICRO-3

- length: 3 m



USB A/MICRO-1 Charging cable, micro USB

USB B
UNIVERSAL SERIAL BUS

- ideal to charge accumulators of portable devices with microUSB-B socket
- usually can be used as data cable as well
- length: 1 m
- USB 2.0 / 5 V $\overline{\text{---}}$ / 1 A



USB A/MINI-1 Charging cable, mini USB

USB B
UNIVERSAL SERIAL BUS

- ideal to charge accumulators of portable devices with mini USB socket
- usually can be used as data cable as well
- length: 1 m
- USB 2.0 / 5 V $\overline{\text{---}}$ / 1 A



SA 2100USB

Adapter with USB socket

2,1 A



- requires USB connection cable
- high current fast charge: 2,1 Amper
- input: 100-240V~ / 50-60 Hz
- USB output: 5V~ / max. 2100 mA



SA 1000USB

Adapter with USB socket

1000 mA



- requires USB connection cable
- input: 230V~ / 50 Hz
- USB output: 5V~ / max. 1000 mA



SA 051

Charging cable, mini-micro USB



- USB-A plug and miniUSB / microUSB-B plug
- usually can be used as data cable as well
- automatic winding
- maximum ≈ 70 cm
- USB 2.0 / 5V~ / 1 A



SA 041

Charging cable, micro USB



- USB-A plug - microUSB-B plug
- usually can be used as data cable as well
- automatic winding
- maximum ≈ 70 cm
- USB 2.0 / 5V~ / 1 A



SA 050/M

Charging cable, micro USB



- USB-A plug - microUSB-B plug
- usually can be used as data cable as well
- built-in magnets in both plugs
- practical to store, flat design
- USB 2.0 / 5V~ / 2,1 A max.
- length: 215 mm



SA 050/GY

Charging cable, micro USB



- USB-A plug - microUSB-B plug
- usually can be used as data cable as well
- built-in magnets in both plugs
- practical to store, flat design
- USB 2.0 / 5V~ / 2,1 A max.
- length: 215 mm



SA 044

OTG cable

2,1 A

- USB-A socket - microUSB-B plug
- two-way data cable, ≈ 16 cm
- copy of files without computer
- playback of video and music from USB storage
- USB 2.0 / 5V~ / 2,1 A



Audio and video connector, accessory

Whether if it's transmission of mono, stereo sound or analog or digital picture, we offer a wide range of choices. Among the excellent quality ready-made connection cables, we offer mountable connection sockets, plugs and wires which meets specific needs of each customer. Our continuously updated range keeps up with the actual trends, in order to all entertainment devices can be connected to each other.

HD SERIES

HDMI cable

GOLD

- V 1.4 version
- gilded
- "A" plug - "A" plug



type	length
HD 1,5	1,5 m
HD 3	5,0 m

HDS SERIES

HDMI cable

GOLD

- V 1.4 version
- gilded
- "A" plug - "A" plug



type	length
HDS 1	1 m
HDS 2	2 m
HDS 4,5	4,5 m

HD A1

HDMI converter

GOLD

STEREO

- gilded
- "A" socket - "D" (micro) and "C" (mini) plug



HD A2

HDMI converter

GOLD

- gilded
- "A" socket - "A" plug

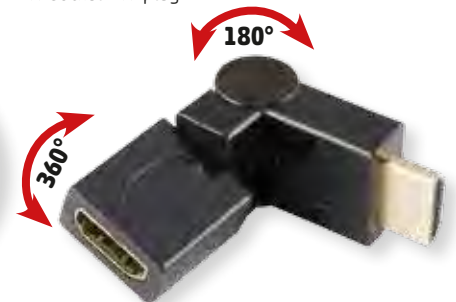

DTA HIFI

Digital-analog audio converter

- ENJOY THE SOUND OF THE LCD TV THROUGH YOUR HIFI SYSTEM!
- connection of devices with digital audio output and stereo devices without digital input
 - good quality sounding of LCD TV, Set Top Box, DVB-T receiver, DVD/Blue-ray player... through HiFi devices, active sound boxes...
 - converts the digital or optical audio signal to traditional analog stereo signal
 - input 2in1: optical TOSLINK + digital coaxial RCA
 - output: 2 x RCA connection socket, stereo
 - accessory: 1.5 m optical connection cable, mains adapter (5 V / 1 A)
 - size: 51 x 26 x 41 mm

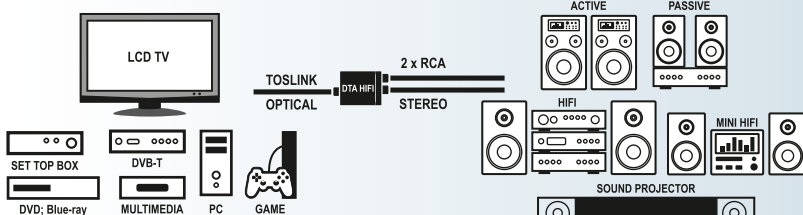

HDMI connector, audio converter

SVS 6011

Video cable kit

STEREO

- 1 pc of 6 pole DIN plug - 6 pole DIN plug (1,5 m)
- 2 pcs of 6 pole DIN socket - 3 x RCA plugs (0,2 m)
- 1 pc of 21 pole euro plug - 6 pole DIN socket (IN)
- 1 pc of 21 pole euro plug - 6 pole DIN socket (OUT)
- 1 pc of BNC plug RCA socket
- pouch packaging



V 81-3

Video cable distributor

STEREO

- 21 pole euro plug - 3 x 21 pole euro socket
- 1,5 m



VC 3D

Video cable

STEREO

- 1,5 m
- 21 pole euro plug - 21 pole euro plug
- 21 poles connected



VC 3D-3

- 3 m

V 50SG

Video converter

GOLD

STEREO

- 21 pole euro plug - 3 x RCA socket + SVHS socket
- with stereo converter switch
- gilded



V 50S

Video converter

STEREO

- 21 pole euro plug - 3 x RCA socket + SVHS socket
- with stereo converter switch



V 52S

Video converter

STEREO

- 21 pole euro plug - 3 x RCA socket
- + 21 pole euro socket converter
- with stereo converter switch
- with switch



V 56

Video cable

STEREO

- 21 pole euro plug - 6 x RCA plug
- 1,5 m



A 4 SERIES

Audio cable



- 3 x RCA plug
- 3 x RCA plug



type	length
A 4	1 m
A 4-3	3 m

A 70FC-1,5

Audio cable



- 4 x RCA plug - 4 x RCA plug
- Ø9 + 1,5 + 9 mm
- oxygen-free copper base material for higher audio fidelity
- metal, gilded connector plugs
- slitted, resilient contact pins
- blue, transparent insulation
- with remote wire
- 1,5 m

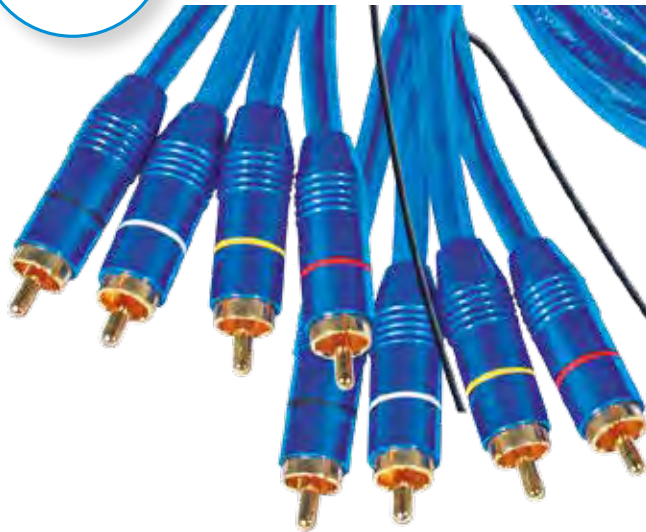

VC 20-2

Video cable



- 4 pole Ø3,5 mm plug - 3 x RCA plug
- suitable for the most video cameras
- 2 m



V1

Video cable

- BNC plug - BNC plug
- only for video signal
- 1,5 m



A3 SERIES

Audio cable

- 2 x RCA plug - 2 x RCA plug



type	length
A 3	1,5 m
A 3-3	3 m
A 3-5	5 m
A 3-10	10 m

SA 040

Audio cable

- automatic winding
- ideal for input of car radios
- suitable for headphone output (mobile phone, navigation system, tablet...)
- 2 x Ø3,5 mm gilded 90° plug
- max. 80 cm



A 49 SERIES

Audio cable

- Ø3,5 mm stereo plug - 2 x RCA plug



type	length
A 49	1,5 m
A 49-5	5 m
A 49-10	10 m

A 51 SERIES

Audio cable

- Ø3,5 mm stereo plug
- Ø3,5 mm stereo plug



type	length
A 51	1,5 m
A 51-5	5 m

A 54-5

Audio cable

- Ø3,5 mm stereo plug
- Ø3,5 mm stereo socket
- 5 m



A 65

Audio cable

- 5 pole DIN plug - Ø3,5 mm stereo plug
- 1,5 m



OPK 2/1,5

Optical cable

- Toslink plug - Toslink plug
- Ø2,2 mm
- with dustproof cap
- 1,5 m



Stereo connector cable family

- first class quality
- HI-FI audio quality wire
- gilded connectors
- aluminium coverage
- excellent, interfere-free contact
- unique design
- ideal for portable and home appliances



AC 16M

Audio distributor

- Ø3,5 mm stereo plug - 2 x Ø3,5 mm stereo sockets
- 15 cm



A 54-2.5M

Audio cable

- Ø3,5 mm stereo plug - Ø3,5 mm stereo socket
- 2,5 m



A 51-1M

Audio cable

- Ø3,5 mm straight stereo plug - Ø3,5 mm pipe stereo plug
- 1 m



A 49-1M

Audio cable

- Ø3,5 mm stereo plug - 2 x RCA plugs
- 1 m



A 3-1M

Audio cable

- 2 x RCA plugs - 2 x RCA plugs
- 1 m



RCA 11MF

RCA plug pair

GOLD

- metal
- gilded
- with strain relief
- only with composite colour marks

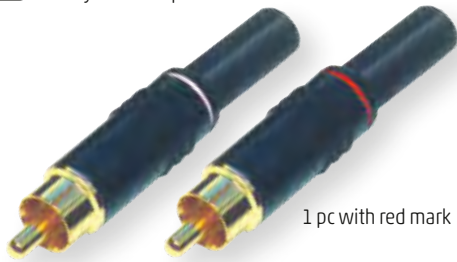

1 pc with white mark

1 pc with red mark

RCA 11G

RCA plug

GOLD

- with black mark
- metal
- gilded
- with strain relief



RCA 12G

- with red mark

RCA 11

RCA plug

- black

- plastic
- with strain relief



RCA 21

RCA socket

- black

- plastic
- with strain relief



RCA 12

- red

RCA 22

- red

SK 4P

Jack plug

- Ø3,5 mm stereo plug
- plastic
- pipe shape



SK 5

Jack plug

- Ø3,5 mm mono plug
- plastic
- with strain relief



SK 4MK

Jack socket

- Ø3,5 mm stereo socket
- metal
- with strain relief



SK 4K

Jack socket

- Ø3,5 mm stereo socket
- plastic
- with strain relief



SK 3M

Jack plug

- Ø6,3 mm stereo plug
- metal
- with strain relief



SK 2M

Jack plug

- Ø6,3 mm mono plug
- metal
- with strain relief

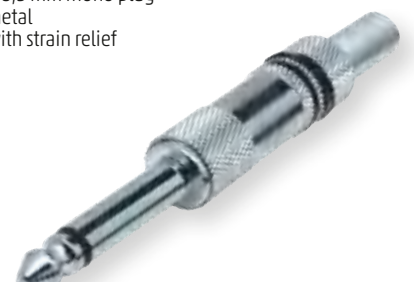

SK 4M

Jack plug

- Ø3,5 mm stereo plug
- metal
- with strain relief

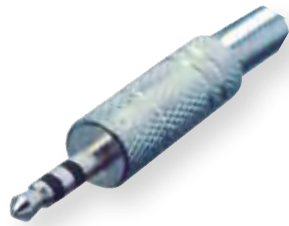

SK 4

Jack plug

- Ø3,5 mm stereo plug
- plastic
- with strain relief



SK 4EB

Jack socket

- Ø3,5 mm stereo build-in socket
- plastic

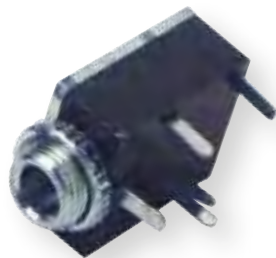

S 5

DIN plug

- 5 pole tuchel



AC 18

RCA distributor

- 1 x RCA plug - 2 x RCA sockets
- plastic
- mono

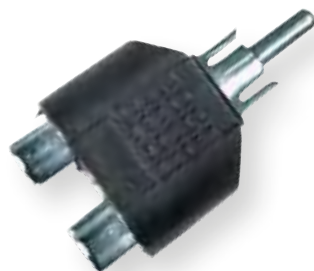

AC 19

RCA extension

- RCA socket - RCA socket
- plastic
- mono



AC 16

Audio converter

- Ø3,5 mm stereo plug - 2 x Ø3,5 mm stereo socket converter



AC 17

Audio converter

- Ø3,5 mm stereo plug - 2 x RCA socket converter



AC 9

Audio converter

- Ø6,3 mm stereo plug
- Ø3,5 mm stereo socket converter



AC 4

Audio converter

- Ø6,3 mm mono plug
- RCA socket converter



AC 6

Audio converter

- Ø3,5 mm stereo plug - Ø6,3 mm stereo socket converter



MC 625/BK

2 core microphone cable

- 2 x 0,35 mm²
- 2C x (31 x 0,12 mm)/(128 x 0,12 mm) fabric + paper
- outer diameter: 6,2 mm
- round, black
- 50 m/spool



KN 7

4 core shielded cable

- 4 x 0,08 mm²
- 4C x (10 x 0,10 mm)/4 x (28 x 0,12 mm)
- outer diameter: 5,0 mm
- each core is shielded, round, black
- 100 m/spool



KN 6

2 core shielded cable

- 2 x 0,08 mm²
- 2C x (10 x 0,10 mm)/2 x (28 x 0,12 mm)
- outer diameter: 2,8 x 5,6 mm
- each core is shielded, flat, black
- 100 m/spool



KN 4

1 core shielded cable

- 1 x 0,14 mm²
- 1C x (12 x 0,12 mm)/(28 x 0,12 mm)
- outer diameter: 2,8 mm
- round, black
- 100 m/spool



S 6 SERIES

Coaxial cable

PROFESSIONAL **3 SHIELD**
75 Ohm **Ø7,06 mm**

- impedance: 75 Ω
- Ø7,06 mm PVC insulation
- aluminium + PET foil
- Ø0,12 mm x 80 threads, ALU hose
- aluminium + PET foil
- Ø4,6 mm foamed PE insulation
- Ø1,02 mm copper coated steel internal thread

RG 6U SERIES

Coaxial cable

75 Ohm **Ø6,9 mm**

- impedance: 75 Ω
- Ø6,9 mm PVC insulation
- Ø0,12 mm x 48 threads, ALU hose
- aluminium + PET foil
- Ø4,6 mm foamed PE insulation
- Ø1,0 mm copper coated steel internal thread



type	colour	length
S 6TSV/WH	white	305 m / spool
S 6TSV/BK	black	305 m / spool
S 6TSP/WH	white	100 m / spool



type	colour	length
RG 6U/WH	white	100 m / spool
RG 6U/BK	black	100 m / spool
RG 6U-500/WH	white	500 m / spool

KH 3

Coaxial cable

75 Ohm **Ø4,2 mm**
100 meters

- impedance: 75 Ω
- Ø4,2 mm PVC insulation
- Ø0,12 mm x 48 thread, copper hose
- aluminium foil
- Ø2,6 mm foamed PE insulation
- Ø0,5 mm copper coated steel internal thread
- white
- 100 m/spool



RG 6-32 SERIES

Coaxial cable

75 Ohm **Ø6,5 mm**

- impedance: 75 Ω
- Ø6,5 mm PVC insulation
- Ø0,12 mm x 32 thread, copper hose
- aluminium + PET foil
- Ø4,6 mm foamed PE insulation
- Ø0,9 mm copper internal thread



type	colour	length
RG 6-32/WH	white	100 m / spool
RG 6-32/BK	black	100 m / spool

RG 58

Coaxial cable

50 Ohm **Ø5 mm**

100 meters

- impedance: 50 Ω
- Ø5,0 mm PVC insulation
- Ø0,12 mm x 96 thread, copper hose
- Ø2,95 mm PE insulation
- Ø0,18 mm x 19 copper internal thread
- black
- 100 m/spool



RG59+NAP

Coaxial cable with power cable

75 Ohm **100 meters**

- black
- RG 59 (75 Ω) + 2 x 0,5 mm²
- 100 m/spool

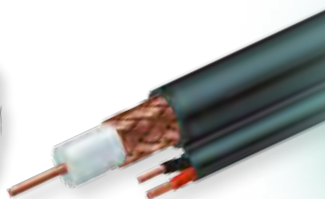

SAT CABLE

Coaxial cable

75 Ohm **Ø6 mm**

100 meters

- impedance: 75 Ω
- Ø6,0 mm PVC insulation
- Ø0,12 mm x 48 threads, ALU hose
- aluminium foil
- Ø3,71 mm foamed PE insulation
- Ø0,65 mm copper coated steel inner thread
- white
- 100 m/spool



type	colour	impedance	exterior	shading/other	dielectric	inner thread	length
S 6TSV/WH	white	75 Ω	Ø7,06 mm PVC	aluminium + PET foil / Ø0,12 mm x 80 threads, ALU hose / aluminium + PET foil	Ø4,6 mm foamed PE	Ø1,02 mm copper coated steel	305 m
S 6TSV/BK	black	75 Ω	Ø7,06 mm PVC	aluminium + PET foil / Ø0,12 mm x 80 threads, ALU hose / aluminium + PET foil	Ø4,6 mm foamed PE	Ø1,02 mm copper coated steel	305 m
S 6TSP/WH	white	75 Ω	Ø7,06 mm PVC	aluminium + PET foil / Ø0,12 mm x 80 threads, ALU hose / aluminium + PET foil	Ø4,6 mm foamed PE	Ø1,02 mm copper coated steel	100 m
RG 6U/WH	white	75 Ω	Ø6,9 mm PVC	Ø0,12 mm x 48 threads, ALU hose / aluminium + PET foil	Ø4,6 mm foamed PE	Ø1 mm copper coated steel	100 m
RG 6U/BK	black	75 Ω	Ø6,9 mm PVC	Ø0,12 mm x 48 threads, ALU hose / aluminium + PET foil	Ø4,6 mm foamed PE	Ø1 mm copper coated steel	100 m
RG 6U-500/WH	white	75 Ω	Ø6,9 mm PVC	Ø0,12 mm x 48 threads, ALU hose / aluminium + PET foil	Ø4,6 mm foamed PE	Ø1 mm copper coated steel	500 m
RG 6-32/WH	white	75 Ω	Ø6,5 mm PVC	Ø0,12 mm x 32 threads, copper hose / aluminium + PET foil	Ø4,6 mm foamed PE	Ø0,9 mm copper	100 m
RG 6-32/BK	black	75 Ω	Ø6,5 mm PVC	Ø0,12 mm x 32 threads, copper hose / aluminium + PET foil	Ø4,6 mm foamed PE	Ø0,9 mm copper	100 m
SAT CABLE	white	75 Ω	Ø6 mm PVC	Ø0,12 mm x 48 threads, ALU hose / aluminium + PET foil	Ø3,71 mm foamed PE	Ø0,65 mm copper coated steel	100 m
KH 3	white	75 Ω	Ø4,2 mm PVC	Ø0,12 mm x 48 threads, copper hose / aluminium foil	Ø2,6 mm foamed PE	Ø0,5 mm copper coated steel	100 m
RG 58	black	50 Ω	Ø5 mm PVC	Ø0,12 mm x 96 threads, copper hose	Ø2,95 mm PE	Ø0,18 mm x 19 copper	100 m
RG59+NAP	black	75 Ω		RG59 + 2 x 0,5 mm ² integrated copper cable			100 m

RFK SERIES

Coaxial cable

- pipe shaped coaxial plug - pipe shaped coaxial socket
- double shielding



type	colour	length
RFK 1	white	1,5 m
RFK 5	white	5,0 m

RF SERIES

Coaxial cable

- coaxial plug - coaxial socket
- double shielding



type	colour	length
RF 1	white	1,5 m
RF 3	white	3 m
RF 5	white	5,0 m
RF 10	white	10 m

FS 28

Coaxial distributor

- 1 x plug - 2 x sockets
- „T“- shaped, metal



FS 27

Coaxial distributor

- 2 x plugs - 1 x socket
- „T“- shaped, metal



FST 1

Coaxial plug

- metal, it may be coiled directly on RG 6 cable



FST 2

Coaxial socket

- metal, it may be coiled directly on RG 6 cable



FS 1C

Coaxial plug

- metal, straight
- crimpable



FS 2C

Coaxial socket

- metal, straight
- crimpable



FS 14

Coaxial plug

- metal, straight
- can be screwed



FS 15

Coaxial socket

- metal, straight
- can be screwed



FS 905

Coaxial plug

- metal
- solderable



FS 1

Coaxial plug

- pipe-shaped
- can be screwed



FS 2

Coaxial socket

- pipe-shaped
- can be screwed



FS 18

Coaxial plug

- straight, reinforced
- can be screwed



FS 19

Coaxial socket

- straight, reinforced
- can be screwed





FF 1/PRO
 F plug, for RG 6
 - metal
HIGH QUALITY

FF 1
 F plug, for RG 6
 - metal

FF 4
 F plug, for SAT CABLE
 - metal

FF 21
 F plug for KH3
 - metal

F 803C
 F plug, crimpable
 - for S 6TSV cable
 - compressible type

FF 10S
 F socket
 - front type
 - 15 mm long
 - with nut and pad

FF 14
 F extension
 - plug - plug

FF 13
 F extension
 - socket - socket

FF 15
 F plug - F socket
 - pipe-shaped

FF 18
 Converter
 - coaxial plug - F socket

FF 19
 Converter
 - coaxial plug - F socket

S 29-6C
 BNC plug
 - for RG 6 cable
 - compressible type

S 29-5C
 BNC plug
 - for RG 6 cable
 - compressible type

S 42
 Audio converter
 - BNC plug - RCA socket

TSP SERIES F distributor
 - applicable for cable television and satellite
 - 900 - 2400 MHz

TS SERIES F distributor
 - applicable for cable television and radio
 - 5 - 900 MHz

pic.	type	specification	connection
1	TSP 1913	4-way	1 x input - 4 x output
2	TSP 1911	3-way	1 x input - 3 x output
3	TSP 1910	2-way	1 x input - 2 x output
4	TSP 1909	2-way, „T“- shape	1 x input - 2 x output

pic.	type	specification	connection
1	TS 1913	4-way	1 x input - 4 x output
2	TS 1911	3-way	1 x input - 3 x output
3	TS 1910	2-way	1 x input - 2 x output
4	TS 1909	2-way, „T“-shape	1 x input - 2 x output

F and BNC connector, converter, distributor

STV 101

Lighting rocker switch

- 2 circuits - 2 positions
- 250 V~ / 10 A



STV 15

Lighting rocker switch

- 1 circuit - 2 positions
- 250 V~ / 6 A



STV 03

Lighting rocker switch

- 1 circuit - 2 positions
- 250 V~ / 10 A



STV 04

Lighting rocker switch

- 1 circuit - 2 positions
- 250 V~ / 10 A



STV 07

Lighting rocker switch

- 1 circuit - 2 positions
- 250 V~ / 6 A



STV 08

Lighting rocker switch

- 1 circuit - 2 positions
- 250 V~ / 6 A



STV 11

Lighting rocker switch

- 1 circuit - 2 positions
- 250 V~ / 6 A



STV 12

Lighting rocker switch

- 1 circuit - 2 positions
- 250 V~ / 6 A



STV 05

Lighting rocker switch

- 2 circuits - 2 positions
- 250 V~ / 5 A



STV 06

Lighting rocker switch

- 2 circuits - 2 positions
- 250 V~ / 5 A



STV 01

Lighting rocker switch

- 2 circuits - 2 positions
- 250 V~ / 10 A



STV 02

Lighting rocker switch

- 2 circuits - 2 positions
- 250 V~ / 10 A



	max.load (V/A)	number of coupled circuits	button/ lever/knob positions	size of switch (mm)	mounting size/slot (YxZ or Ø)	mounting depth with mechanical lugs (mm)	number of mechanical lugs	width of mechanical lugs (mm)	type of light source	power supply of light source	switch connection	light source connection
STV 101	250V~/10A	2	2 / key	32 x 26	31 x 22	27	4	6,3	glimm	230 V~	2	a
STV 15	250V~/6A	1	2 / key	21 x 15	20 x 13	22	3	4,8	glimm	230 V~	1	b
STV 03	250V~/10A	1	2 / key	34 x 14	31 x 11	26,6	3	6,3	glimm	230 V~	1	b
STV 04	250V~/10A	1	2 / key	34 x 14	31 x 11	26,6	3	6,3	glimm	230 V~	1	b
STV 07	250V~/6A	1	2 / key	Ø23	Ø21	24	3	4,8	glimm	230 V~	1	c
STV 08	250V~/6A	1	2 / key	Ø23	Ø21	24	3	4,8	glimm	230 V~	1	c
STV 11	250V~/6A	1	2 / key	Ø23	Ø21	24	3	4,8	glimm	230 V~	1	c
STV 12	250V~/6A	1	2 / key	Ø23	Ø21	24	3	4,8	glimm	230 V~	1	c
STV 05	250V~/6A	2	2 / key	21 x 15	20 x 13	22	4	4,8	glimm	230 V~	2	d
STV 06	250V~/6A	2	2 / key	21 x 15	20 x 13	22	4	4,8	glimm	230 V~	2	d
STV 01	250V~/10A	2	2 / key	32 x 26	31 x 22	27	4	6,3	glimm	230 V~	2	a
STV 02	250V~/10A	2	2 / key	32 x 26	31 x 22	27	4	6,3	glimm	230 V~	2	a

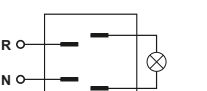
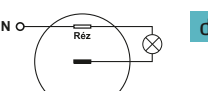
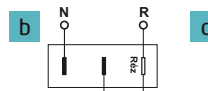
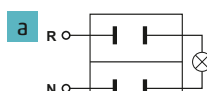
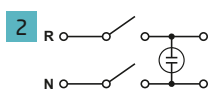
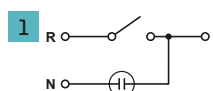

switch

<p>ST 1/RD</p> 	<p>Mini rocker switch</p> <p>- 1 circuit - 2 positions - 250 V~ / 3 A</p> 	<p>ST 1/BK</p> 	<p>Mini rocker switch</p> <p>- 1 circuit - 2 positions - 250 V~ / 3 A</p> 
<p>ST 315</p> 	<p>Rocker switch</p> <p>- 1 circuit - 2 positions - 125 V~ / 3 A</p> 	<p>ST 316</p> 	<p>Rocker switch</p> <p>- 2 circuits - 2 positions - 125 V~ / 3 A</p> 
<p>ST 302</p> 	<p>Rocker switch</p> <p>- 1 circuit - 2 positions - 250 V~ / 3 A</p> 	<p>ST 304</p> 	<p>Rocker switch</p> <p>- 2 circuits - 2 positions - 250 V~ / 3 A</p> 
<p>ST 303</p> 	<p>Rocker switch</p> <p>- 1 circuit - 3 positions - 250 V~ / 3 A</p> 	<p>ST 305</p> 	<p>Rocker switch</p> <p>- 2 circuits - 3 positions - 250 V~ / 3 A</p> 
<p>ST 21</p> 	<p>Rocker switch</p> <p>- 1 circuit - 2 positions - 250 V~ / 6 A</p> 	<p>ST 22</p> 	<p>Rocker switch</p> <p>- 1 circuit - 3 positions - 250 V~ / 6 A</p> 
<p>ST 10/BK</p> 	<p>Rocker switch</p> <p>- 1 circuit - 2 positions - 250 V~ / 3 A</p> 	<p>ST 10/RD</p> 	<p>Rocker switch</p> <p>- 1 circuit - 2 positions - 250 V~ / 3 A</p> 

	max.load (V/A)	number of coupled circuits	button/lever/knob positions	size of switch (mm)	mounting size/slot (x2 or Ø)	mounting depth with mechanical lugs (mm)	number of mechanical lugs	width of mechanical lugs (mm)	switch connection
ST 1/RD	250 V~ / 3 A	1	2 / key	21 x 15	20 x 13	18,5	2	4,8	3
ST 1/BK	250 V~ / 3 A	1	2 / key	21 x 15	20 x 13	18,5	2	4,8	3
ST 315	125 V~ / 3 A	1 (alternate)	2 / lever	8 x 5	Ø5	13,5	3	1,5	4
ST 316	125 V~ / 3 A	2 (alternate)	2 / lever	8 x 9	Ø5	13,5	6	1,5	5
ST 302	250 V~ / 3 A	1 (alternate)	2 / lever	13 x 8	Ø6	15	3	2	4
ST 304	250 V~ / 3 A	2 (alternate)	2 / lever	13 x 13	Ø6	15	6	2	5
ST 303	250 V~ / 3 A	1 (alternate)	3 / lever	13 x 8	Ø6	15	3	2	6
ST 305	250 V~ / 3 A	2 (alternate)	3 / lever	13 x 13	Ø6	15	6	2	7
ST 21	250 V~ / 6 A	1 (alternate)	2 / lever	29 x 16	Ø11,5	28,2	3	6,3	4
ST 22	250 V~ / 6 A	1 (alternate)	3 / lever	29 x 16	Ø11,5	28,2	3	6,3	6
ST 10/BK	125 V~ / 3 A	1	2 / knob	Ø19	Ø12	28,5	2	2,8	3
ST 10/RD	125 V~ / 3 A	1	2 / knob	Ø19	Ø12	28,5	2	2,8	3

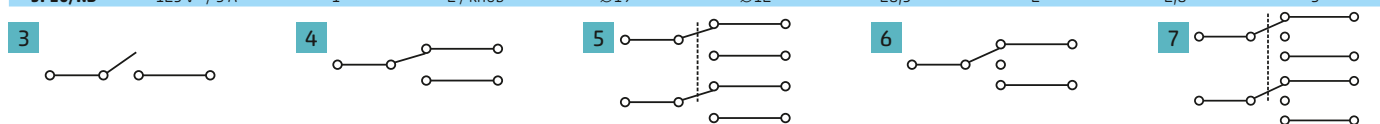

SP 10/BK

Push button

- 1 circuit
- closing - OFF - (ON)
- 125 V~ / 3 A



SP 10/RD

Push button

- 1 circuit
- closing - OFF - (ON)
- 125 V~ / 3 A
- red



SP 12/RD

Push button

- 1 circuit
- closing - OFF - (ON)
- 250 V~ / 1,5 A
- red



SP 12/GR

Push button

- 1 circuit
- closing - OFF - (ON)
- 250 V~ / 1,5 A
- green



SP 01/BK

Push button

- mini closing
- 1 circuit
- black



SP 01/RD

Push button

- mini closing
- 1 circuit
- red



SP 02/BK

Push button

- mini closing
- 1 circuit
- black



HIGH QUALITY

SP 02/RD

Push button

- mini closing
- 1 circuit
- red



HIGH QUALITY

MSW 11

Micro switch

- 1 circuit - alternate - ON - (ON)
- 250 V~ / 5 A - mini size
- external dimensions: 20 x 10 x 6 mm



MSW 13

Micro switch

- 1 circuit - alternate - ON - (ON)
- 250 V~ / 5 A - mini, pinch roller
- external dimensions: 20 x 10 x 6 mm



MSW 01

Micro switch

- 1 circuit - alternate - ON - (ON)
- 250 V~ / 10 A
- external dimensions: 28 x 16 x 10 mm



MSW 03

Micro switch

- 1 circuit - alternate - ON - (ON)
- 250 V~ / 10 A - pinch roller
- external dimensions: 28 x 16 x 10 mm



	max.load (V / A)	number of coupled circuits	button/lever/knob positions	size of switch (mm)	mounting size/slot (YxZ or Ø)	mounting depth with mechanical lugs (mm)	number of mechanical lugs	width of mechanical lugs (mm)	switch connection
SP 10/BK	125 V~ / 3 A	1	2 / knob	Ø19	Ø12	28,5	2	2,8	3
SP 10/RD	125 V~ / 3 A	1	2 / knob	Ø19	Ø12	28,5	2	2,8	3
SP 12/RD	250 V~ / 1,5 A	1	2 / knob	Ø14	Ø13	21	2	2	3
SP 12/GR	250 V~ / 1,5 A	1	2 / knob	Ø14	Ø13	21	2	2	3
SP 01/BK	12 V / 1 A	1	2 / knob	Ø7	Ø7	16	2	2,8	3
SP 01/RD	12 V / 1 A	1	2 / knob	Ø7	Ø7	16	2	2,8	3
SP 02/BK	250 V~ / 1,5 A	1	2 / knob	Ø7	Ø7	15	2	2	3
SP 02/RD	250 V~ / 1,5 A	1	2 / knob	Ø7	Ø7	15	2	2	3
MSW 11	250 V~ / 5 A	1	2 / knob	20 x 11 x 7	20 x 10,7 x 6,5		3	2,8	4
MSW 13	250 V~ / 5 A	1	2 / lever	20 x 11 x 7	20 x 10,7 x 6,5		3	2,8	4
MSW 01	250 V~ / 10 A	1	2 / knob	29 x 16 x 10	29 x 16 x 10,3		3	6,3	4
MSW 03	250 V~ / 10 A	1	2 / lever	29 x 16 x 10	29 x 16 x 10,3		3	6,3	4

3

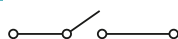

4

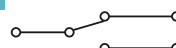

AK 01 Lighting rocker switch

- 1 circuit - 2 positions
- 12V



AKV 01 Lighting rocker switch

- 1 circuit - 2 positions
- 12V



AKV 02 Lighting rocker switch

- 1 circuit - 2 positions
- 12V



AKV 11 Lighting rocker switch

- 1 circuit - 2 positions
- 12V



AKV 12 Lighting rocker switch

- 1 circuit - 2 positions
- 12V



AK 11 Lighting rocker switch

- 1 circuit - 2 positions
- 14V



AK 12 Lighting rocker switch

- 1 circuit - 2 positions
- 14V



AKV 62 Lighting rocker switch for window lifter

- 2 circuits - 3 positions
- for window lifter
- (ON) - OFF - (ON)
- 12V



AK 61 Rocker switch

- 2 circuits - 3 positions
- for window lifter
- (ON) - OFF - (ON)
- 12V



	max. load (V/A)	number of coupled circuits	button/lever/knob positions	size of switch (mm)	mounting size/slot (YxZ or Ø)	mounting depth with mechanical lugs (mm)	number of mechanical lugs	width of mechanical lugs (mm)	type of light source	power supply of light source	switch connection	light source connection
AK 01	12V/20A	1	2 / lever	25 x 14	Ø12	28	3	6,3	bulb	12 V	8	
AKV 01	12V/15A	1	2 / key	21 x 15	19 x 13	22,8	3	4,8	bulb	12 V	8	
AKV 02	12V/15A	1	2 / key	21 x 15	19 x 13	22,8	3	4,8	bulb	12 V	8	
AKV 11	12V/16A	1	2 / key	Ø23	Ø20	22,8	3	4,8	bulb	12 V	8	
AKV 12	12V/16A	1	2 / key	Ø23	Ø20	22,8	3	4,8	bulb	12 V	8	
AK 11	14V/20A	1	2 / key	Ø23	Ø20	23,5	3	4,8	red LED	12 V	9	
AK 12	14V/20A	1	2 / key	Ø23	Ø20	23,5	3	4,8	green LED	12 V	9	
AKV 62	12V/15A	2	3 / key	21 x 38	37 x 18	24,5	5	4,8	red LED	12 V	10	c
AK 61	12V/15A	2	3 / key	21 x 38	37 x 18	24,5	5	4,8			11	c

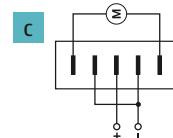
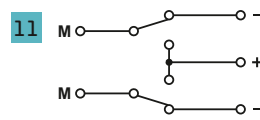
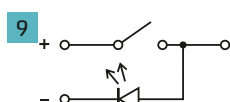

AC 1D

AC plug

- 3 pole (250 V~ / 10 A / 2300 W)
- can be screwed



AC 1A

AC socket

- 3 pole (250 V~ / 10 A / 2300 W)
- can be screwed



AC 2D

AC build-in plug

- 3 pole (250 V~ / 10 A / 2300 W)
- solderable



AC 2A

AC build-in socket

- 3 pole (250 V~ / 10 A / 2300 W)
- solderable



ET 1102

Terminal box

- can be integrated to PCB
- 2 pole

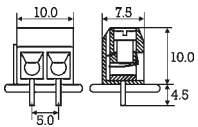

ET 1103

Terminal box

- can be integrated to PCB
- 3 pole

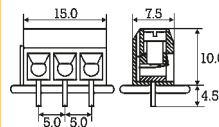

BF 52L

Fuse socket

- bayonet
- 5 x 20 mm



BF 53L

Fuse socket

- can be screwed
- 5 x 20 mm



BF 52B

Fuse socket

- 5 x 20 mm
- open by hand



Fuse

type	nature
F100 MA	5 x 20 mm fast
F250 MA	5 x 20 mm fast
F315 MA	5 x 20 mm fast
F500 MA	5 x 20 mm fast
F1 A	5 x 20 mm fast
F1,25 A	5 x 20 mm fast
F1,6 A	5 x 20 mm fast
F2 A	5 x 20 mm fast

type	nature
F2,5 A	5 x 20 mm fast
F3,15 A	5 x 20 mm fast
F4 A	5 x 20 mm fast
F5 A	5 x 20 mm fast
F6,3 A	5 x 20 mm fast
F8 A	5 x 20 mm fast
F10 A	5 x 20 mm fast
F16 A	5 x 20 mm fast

type	nature
T500 MA	5 x 20 mm slow-break
T1 A	5 x 20 mm slow-break
T2 A	5 x 20 mm slow-break
T2,5 A	5 x 20 mm slow-break
T3,15 A	5 x 20 mm slow-break

type	nature
T4 A	5 x 20 mm slow-break
T5 A	5 x 20 mm slow-break
T6,3 A	5 x 20 mm slow-break
T10 A	5 x 20 mm slow-break

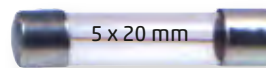

Cable terminal

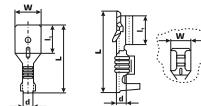

type	size (mm)	d (mm)	L (mm)	l ₁ (mm)	W (mm)	vez. (mm ²)	anyag
KSD 2,8-0,5/Cu	2,8 x 0,5	2,4	15	6,4	2,8	0,5-1	copper
KSD 4,8-0,5/Cu	4,8 x 0,5	3,1	17,5	6,7	4,8	0,5-1	copper
KSD 6,3-0,8/Cu	6,3 x 0,8	3,7	19,7	8,4	6,3	0,5-1	copper
KSD 2,8-0,5/Sn	2,8 x 0,5	2,4	15	6,4	2,8	0,5-1	tinned copper
KSD 4,8-0,5/Sn	4,8 x 0,5	3,1	17,5	6,7	4,8	0,5-1	tinned copper
KSD 6,3-0,8/Sn	6,3 x 0,8	3,7	19,7	8,4	6,3	0,5-1	tinned copper
KSH 2,8-0,5/Cu	2,8 x 0,5	3,1	13	6	3,8	0,5-1	copper
KSH 4,8-0,5/Cu	4,8 x 0,5	2,4	15	6,4	5,7	0,5-1	copper
KSH 6,3-0,5/Cu	6,3 x 0,5	3,1	19	7,7	7,6	0,5-1	copper
KSH 2,8-0,5/Sn	2,8 x 0,5	3,1	13	6	3,8	0,5-1	tinned copper
KSH 4,8-0,5/Sn	4,8 x 0,5	2,4	15	6,4	5,7	0,5-1	tinned copper
KSH 6,3-0,5/Sn	6,3 x 0,5	3,1	19	7,7	7,6	0,5-1	tinned copper

KSD 2,8-0,5/Cu



KSD 4,8-0,5/Cu



KSD 6,3-0,8/Cu



KSD 2,8-0,5/Sn

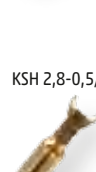

KSD 4,8-0,5/Sn

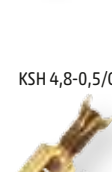

KSD 6,3-0,8/Sn

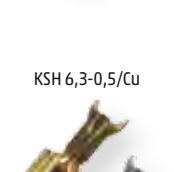

KSH 2,8-0,5/Cu



KSH 4,8-0,5/Cu



KSH 6,3-0,5/Cu



KSH 2,8-0,5/Sn



KSH 4,8-0,5/Sn



KSH 6,3-0,5/Sn

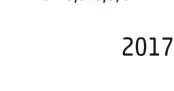

power connector, terminal box, fuse socket, fuse, cable terminal

BH AAA

Battery holder for 1,5 V AAA battery

- with 15 cm wire
- can be screwed



Battery is not included!

BH AA

AA Battery holder for 1,5 V AA battery

- with 15 cm wire
- can be screwed



Battery is not included!

BH 036

Battery connector

- for 9 V battery
- with 15 cm wire



BH 2AAA

Battery holder for two 1,5 V AAA batteries

- 15 cm wire
- can be screwed



Battery is not included!

BH 2AA

Battery holder for two 1,5 V AA batteries

- 15 cm wire
- can be screwed



Battery is not included!

DC 1K

DC inter-cord switch

- cca. 2 x 15 cm wire
- max 12 V ~ • 3 A / 36 W
- Ø2,1 x Ø5,5 x 10 mm
- can be used for LED strip and hobby purposes



DC 1CS

DC connection socket and plug with cable

- cca. 15 cm
- max 12 V ~ • 3 A / 36 W
- Ø2,1 x Ø5,5 x 10 mm



DC 2CS

DC connection socket and plug with terminal block

- max 12 V ~ • 3 A / 36 W
- 0,5-1 mm² wire
- Ø2,1 x Ø5,5 x 10 mm



SN 2

Power supply plug

- 0,7 x Ø2,5 x 9 mm

- with strain relief

SN 10

- 2,1 x Ø5,5 x 14 mm

SN 12

- 2,5 x Ø5,5 x 14 mm



SN 10M

Power supply socket

- 2,1 x Ø5,5 mm

- build-in metal

SN 12M

- 2,5 x Ø5,5 mm





T 6-3/WH

Telephone connection cable

- 4P/4C, spiral
- plug-plug - for handset
- white
- 3 m



T 5 SERIES

Telephone connection cable

- 6P/4C
- plug-plug
- white



type	length
T 5-5/WH	5 m
T 5-10/WH	10 m
T 5-15/WH	15 m
T 5-20/WH	20 m

TK 4

Telephone wire

- 4 x 0,5 mm², copper
- white
- 100 m/spool

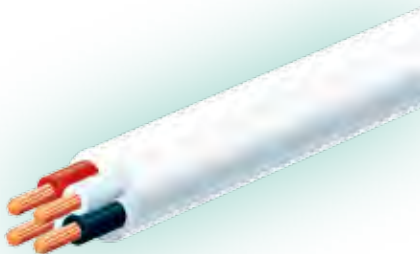

TK 1/BK

Telephone wire

- black

- 4C x (7 x 0,12 mm), copper
- 4 wire
- 100 m/spool



TK 1/WH

- white



TK 2/WH

Telephone wire

- 2C x (7 x 0,12 mm), copper
- 2 wire
- white
- 100 m/spool

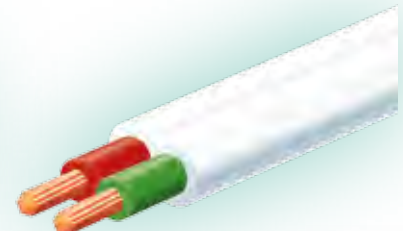

TS 12

Telephone plug

- 4P/4C (RJ 10)
- cimpable type



TS 13

Telephone plug

- 6P/4C (RJ 11)
- cimpable type



TS 14

Telephone plug

- 6P/6C (RJ 12)
- cimpable type



TS 51

Telephone plug

- 8P/8C
- cimpable type
- for ISDN and computer network systems

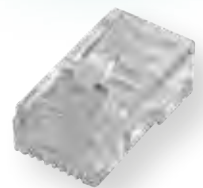

TS 52/BK

Strain relief for RJ-45 plug

- black

- 8P/8C
- protects the plug against damage and contamination
- prevents wire's deflection



TS 52/WH

- white

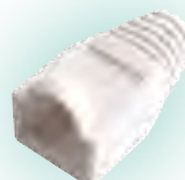

<p>TS 15/WH</p> 	<p>Extender for telephone wire</p> <ul style="list-style-type: none"> - 6P/4C - socket - socket - white 	<p>TT 1-1</p> 	<p>Extender for telephone wire</p> <ul style="list-style-type: none"> - 8P/8C - socket - socket - white 	<p>TS 16-2/WH</p> 	<p>Distributor for telephone wire</p> <ul style="list-style-type: none"> - 6P/4C - 1 x plug - 2 x sockets - white
--	---	--	---	--	---

<p>TS 16-3/WH</p> 	<p>Distributor for telephone wire</p> <ul style="list-style-type: none"> - 6P/4C - 1 x plug - 3 x sockets - white 	<p>TT 18-2</p> 	<p>Distributor for telephone wire</p> <ul style="list-style-type: none"> - 8P/8C - 1 x plug - 2 x sockets - ivory 	<p>TS 17-2</p> 	<p>Distributor for telephone wire</p> <ul style="list-style-type: none"> - 6P/4C - 1 x socket - 2 x sockets - white
--	---	---	---	---	---

TS 1M/WH Telephone wall socket

- 6P/4C
- self-adhesive
- can be screwed
- white



RINGER Telephone expletive bell

- spectacular sound and light signal
- applicable for all the traditional telephone sets
- adjustable volume
- sound signal can be switched off
- connection cable included (1,2 m)



TS 2M/WH Telephone wall socket

- double
- 6P/4C
- self-adhesive
- can be screwed
- white



CT Cable ties

- transparent and black colour
- can't be released
- applicable: -35 - 85°C
- resists acids, alkalis, UV radiation
- recommended for outdoor use

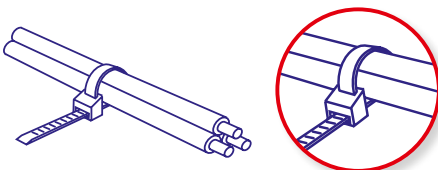

type	colour	length (mm)	width (mm)	pcs / pack
CT 100/2,5	transparent	100	2,5	50
CT 150/3,5	transparent	150	3,5	50
CT 200/3,5	transparent	200	3,5	50
CT 250/4,8	transparent	250	4,8	25
CT 300/4,8	transparent	300	4,8	25
CT 400/4,8	transparent	400	4,8	25
CT 650/8,8	transparent	650	8,8	100
CT 100/2,5/B	black	100	2,5	50
CT 150/3,5/B	black	150	3,5	50
CT 200/3,5/B	black	200	3,5	50
CT 250/4,8/B	black	250	4,8	25
CT 300/4,8/B	black	300	4,8	25
CT 400/4,8/B	black	400	4,8	25

CHR Cable clamp with pin

- for round wire



type	wire diameter	pcs / pack
CHR 5	5 mm	50
CHR 6	6 mm	50
CHR 7	7 mm	50
CHR 8	8 mm	50

telephone connector, accessory, cable tie, cable camp

VBC 200/BK

Accumulator clip 200 A

- black
- insulated
- solderable
- max. 12 V $\overline{\sim}$
- length: 150 mm

VBC 200/RD

- red



VBC 100/BK

Accumulator clip 100 A

- black
- insulated
- solderable
- max. 12 V $\overline{\sim}$
- length: 110 mm

VBC 100/RD

- red



VBC 7/BK

Accumulator clip 50 A

- black
- insulated
- solderable
- max. 12 V $\overline{\sim}$
- length: 100 mm

VBC 7/RD

- red



VBC 30/BK

Accumulator clip 30 A

- black
- insulated
- solderable
- max. 12 V $\overline{\sim}$
- length: 75 mm

VBC 30/RD

- red



ALC 4/BK

Alligator clip with banana tube

- black
- insulated
- can be screwed
- length: 65 mm

ALC 4/RD

- red



VCC 210

Test wire set

10 pcs of 50 cm measuring wire, with insulated VCC 2 clip on both ends



VCC 3/BK

Crocodile clip

- large, length: 55 mm, black
- fully insulated
- solderable

VCC 3/RD

- large, length: 55 mm, red



VCC 2/BK

- medium, length: 45 mm, black

VCC 1/BK

- small, length: 40 mm, black

VCC 2/RD

- medium, length: 45 mm, red

VCC 1/RD

- small, length: 40 mm, red

DRS Heat shrinkable tube

- diameter will decrease to half its size under heating
- colour variations: white, black, red, blue
- temperature range of shrinking: 125°C (90 - 125°C)
- usability: between - 55 - 125 °C
- tension strength: ≥ 12 Mpa
- tensile elongation ≥ 200 %
- change of length: ≤ 5 %
- breakdown strength: ≥ 20 kV/mm
- fire resistancy: VW-1
- material: UV radiation proof polyolefin
- pack: 1 m



type	original diameter	shrunk diameter	colour
DRS 2-1/BK	2 mm	1 mm	black
DRS 2-1/RD	2 mm	1 mm	red
DRS 2-1/WH	2 mm	1 mm	white
DRS 2-1/BL	2 mm	1 mm	blue
DRS 4-2/BK	4 mm	2 mm	black
DRS 4-2/RD	4 mm	2 mm	red
DRS 4-2/WH	4 mm	2 mm	white
DRS 4-2/BL	4 mm	2 mm	blue

type	original diameter	shrunk diameter	colour
DRS 6-3/BK	6 mm	3 mm	black
DRS 6-3/RD	6 mm	3 mm	red
DRS 6-3/WH	6 mm	3 mm	white
DRS 6-3/BL	6 mm	3 mm	blue
DRS 10-5/BK	10 mm	5 mm	black
DRS 10-5/RD	10 mm	5 mm	red
DRS 10-5/BL	10 mm	5 mm	blue
DRS 15-7.5/BK	15 mm	7,5 mm	black
DRS 20-10/BK	20 mm	10 mm	black

SS Insulation tape

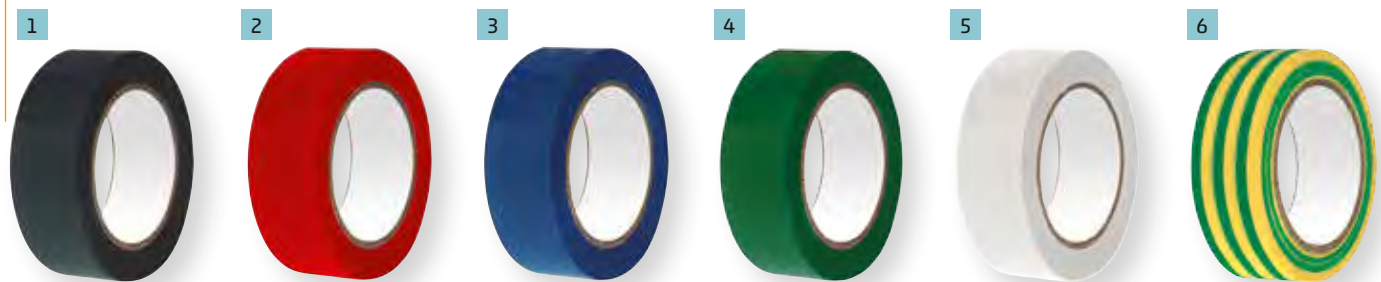

pic.	type	colour	length	width	thickness	pic.	type	colour	length	width	thickness
1	SS 110	black	10 m	19 mm	0,13 mm	1	SS 120	black	20 m	19 mm	0,13 mm
2	SS 210	red	10 m	19 mm	0,13 mm	2	SS 220	red	20 m	19 mm	0,13 mm
3	SS 310	blue	10 m	19 mm	0,13 mm	3	SS 320	blue	20 m	19 mm	0,13 mm
4	SS 410	green	10 m	19 mm	0,13 mm	4	SS 420	green	20 m	19 mm	0,13 mm
5	SS 510	white	10 m	19 mm	0,13 mm	5	SS 520	white	20 m	19 mm	0,13 mm
6	SS 910	green/yellow	10 m	19 mm	0,13 mm	6	SS 920	green/yellow	20 m	19 mm	0,13 mm

RS 50 Adhesive tape



- Silver colour, textil reinforced adhesive tape.
- extremely high breaking strength
 - very good adhesive properties
 - width: 50 mm
 - length: 50 m/spool



RS 50/10 Adhesive tape



- Silver colour, textil reinforced adhesive tape.
- extremely high breaking strength
 - very good adhesive properties
 - width: 50 mm
 - length: 10 m/spool



RS 52/10 Double sided adhesive tape



- very strong adhesion
- width: 50 mm
- length: 10 m/spool



heat shrinkable tube, insulating- and adhesive tape

MO 290206D

Multispray, 200 ml

- universal spray for lubrication, conservation and cleaning of plastic and metal parts.
Moisture-repellent, anti-corrosion
- to remove oil, grease, wax, tar
- creates a thin protective layer after cleaning



MK K61

Contact cleaner and lubricating spray, 300 ml

For the cleaning of heavily soiled equipments. Also provides lubrication.



MK K60

Contact cleaner spray, 300 ml

For the cleaning of heavily soiled equipments.



MK T600

Precision contact cleaner spray, 300 ml

Cleaner for highly sensitive electric components, telecommunication devices, laboratory and industrial devices. It dries without residues.



TK 460

Contact cleaner spray, 150 ml

Chemically active oleaginous agent for the oxide decontamination of electric devices and conductivity restoration.



MO 90505

Contact cleaner spray, 500 ml

For the cleaning of very sensitive electric connectors eg. in vehicles, switching relays, dashboards and alarm systems.



SUPER 10

Contact cleaner spray, 200 ml

High temperature (150 C) efficient switch and contact cleaner, which offers a combination of high purity electrical cleaning and mechanical lubrications for contacts, switches and relays.



W 340

Silicone spray, 300 ml

Commonly used in industry and automotive industry for renewal, maintenance and conservation.



MK SZ01

Silicone spray, 300 ml

Appropriate for attendance, canning and color-refreshing of plastic, leatherettes, and rubber surfaces. Surfaces will be blank, less cracked and delays the process of ageing. Suitable for lubricating moving parts.



W 330

Mounting grease, 300 ml

Lubricating grease, heat resistant up to 160°C with good cohesion properties. It is excellent against corrosion and for lubrication of bearings, sliding cords, mechanical structures and hinges.



MO 290303D

Rust remover spray, 200 ml

High quality product for the removal of rust. Good penetration properties. Contains graphite and MoS2. Moisture-repellent and corrosion protection. The ideal application temperature is between 5-30°C.



LABEL 130

Label remover spray, 200 ml

It can be used for cleaning and easy removal of self-adhesive labels and stickers. A unique blend of citrus and hydrocarbon oils which quickly releases self-adhesive labels and stickers. It neutralizes the adhesive, thereby facilitating clean and easy removal.



MK 1684

Air spray, 300 ml



Suitable to remove dust from hard to reach areas of different electronic equipments, devices, e.g. power supply of computers, keyboards, panels and audiovideo devices, also appropriate at cleansing where other tool is not advisable.

AERO 100/400

Air spray, 400 ml



Can be used safely on keyboards, notebooks, printers, camera devices. It is inflammable formula, so it permits extra safe usage on plastic, rubber, metal or painted surface. With its help, dust and dirt are easily and safely removable from precision devices, from electronic component and from hard reachable spaces without using dissolvent and detergent materials.

MO 090563D

Brake cleaner spray, 500 ml



High quality brake cleaner spray with excellent solvent properties. It leaves no residue. Non-conductive. No corrodation. Ideal for the cleaning of drum brakes, disc brakes, brake pads, calipers, brake shoes. The ideal application temperature is between 5-30°C.

MO 90508

Air conditioner cleansing foam, 500 ml



Air conditioner cleaning and anti-bacterial product, ideal for cleaning car and home air conditioners. It provides fresh pleasant scent.

NEEC200

Screen cleansing gel, 200 ml



- cleansing gel without alcohol and ammonium
- suitable to clean all types of screens (LCD / TFT / PLASMA...)
- microfiber cloth included

NEECTAB4

Cleansing foam for touch screens, 100 ml



- for cleaning the sreen of tablets, notebooks, smart phones
- 1 pc of microfiber cloth

NEECTAB2

Microfiber cloths



- for cleaning the screen of tablets, iPad®, etc...
- 60 pcs of wet wipes
- 1 pc of microfiber cloth

MK 02297

Fire extinguisher



- extinguishing material: 2 kg FUREX ABC PLUS
- propellant: Nitrogen (10 bar / +20 °C)
- efficiency: 13A 89B C
- operating temperature range: -30...+60 °C
- applicable for electronic devices up to 1000 Volt!

MK 02296

Fire extinguisher



- extinguishing material: 1 kg RENEX BC PLUS
- propellant: CO2 patron (12g)
- efficiency: 21B C
- operating temperature range: -20...+60 °C
- applicable for electronic devices up to 1000 Volt!



A

AC plug and socket	218
AC/DC clamp meter	143
accumulator charger	116
accumulator clip	222
accumulator	116
active speaker cabinet pair	173
active subtube	164
adapter connector kit	114
adapter with USB socket	113
adapter with USB socket	203
adapter	114
adhesive tape	223
AGU fuse	198
air conditioner cleaner	225
air cooler	11
air pressure measurer	199
air purifier	16
air spray	225
air vent fan	14
alarm control panel	91
alarm set	91, 93
alligator clip with banana tube	222
anti slip pad	201
arm band (LED)	72
ash collector vacuum, accessories	31
audio cable	206-207
audio converter	209

B

backband microphone	184
baggage scale	8
banana plug	145
banana socket	145
bathroom heater	23
bathroom scale	8
battery	117-118
battery holder	219
battery tester	144
bent nose plier	153
bicycle lamp	71-72
bipolar voltage tester	144
bit set	157
BNC plug	213
brake cleaner spray	225
breathalyser	139
buxus (LED)	54
buzzer	93

C

cable clamp with pin	221
cable reel	120-121
cable terminal	218
cable ties	221
camping lantern	66
candle decoration	50-51
car amplifier	165
car antenna	197
car battery charger	195
car battery connector	198
car compressor	199
car digital video recorder	162
car Hi-Fi cable set	169
car Hi-Fi power capacitor	169
car radio and multimedia player	160-161
car speaker pair	166-168
car subwoofer cabinet	165
car subwoofer	164
car USB charger	196
carbon fibre heater	24
carbon monoxide alarm	36
carrying frame (for floodlights)	77
cat and animal repellent	39
ceiling and wall light	83-85
ceiling light	81-82
ceiling speaker	183
ceramic heater	22
charging cable (micro and mini USB)	202-203
cherry tree decoration	54
chopper	7
cigarette lighter plug, socket	196
coaxial cable stripper	153
coaxial cable	210-212
coaxial plugs and sockets	212
coffee maker, accessories	4
combination plier	152
connectable light curtain, accessory	56-57
contact cleaner	224
convection heater	27-28
cord lamp	67
crimping tool	154-155
crocodile clip	222
crocodile plier	152
crossover	169
crossover	191
cutter	151
cutting nipper	152

D

DC connector socket and plug	219
DC inter-cord switch	219
decoration bottle with light chain.....	43
decoration for light chains	55
dehumidifier	15-16
desk fan	13
desk microphone.....	186
desoldering pump.....	148
diagonal cutting plier.....	153
digital alarm clock.....	107-108
digital thermometer.....	139
digital-analog audio converter	204
DIN plug.....	209
disco globe, disco light.....	62-63
distributor for cigarette lighter	196
dome tweeter	177-178
door and window opening alarm.....	94
doorbell.....	99-102
doorphone	96-98
double-sided adhesive tape	223
dummy camera	95
DVB-T receiver	109

E

earphone.....	189
electric fireplace	17-19
electric kettle.....	5
electrical equipments.....	133
energy saving bulbs	87
entry alarm.....	94
evaporator mat	11
expletive bell (for telephones)	221
extension cord.....	122

F

F distributor	213
F plugs and sockets.....	213
fan heater.....	29
fibre optic LED light.....	52
fire detector and heat speed sensor.....	36
fire extinguisher	225
fitness watch	138
flashlight	67-69
flexible light with USB connection	69
floodlight with solar panel	78
floodlight	77
floor fan.....	14
FM modulator	163

FM transmitter	163
foot pump.....	199
frost guard.....	28
furniture lighting.....	67
fuse socket.....	218
fuse.....	218

G

garden console lamp.....	85
gas soldering tool	148
gate opener.....	95
glue gun	150
glue rod	150
grounded plug	129

H

hair dryer	9
halogen bulbs	88
halogen floodlight, accessories	79-80
halogen heater.....	26
halogen heater.....	24, 26
hand blender, hand mixer	7
handheld magnifier	159
handheld microphone	186
HDMI cable.....	204
HDMI converter.....	204
head light for kids	60
headlamp	70
heat and smoke detector	36
heat shrinkable tube	223
hex key set.....	158

I

indoor antenna	110
indoor timer	131
infra lamp	139
infrared alarm	92
insect killer	37
insect repellent.....	38
insulating tape	223

J

junction box	133
--------------------	-----

K

kids' table lamp.....	59
kitchen scale.....	8

L

label remover spray	224
lamp with dynamo	69
laser light projector	63
LCR meter	143
lead battery	115
LED bulb, cylindrical	86
LED bulbs	88
LED lantern	41-43
LED light for kids	61
light chain	52-53
long nose plier	153

M

magnifying lamp, accessories	75-76
measuring cord	144
measuring tape	145
mechanic grease	224
micro cutting plier	153
micro switch	216
microphone cable	210
microphone clamp	186
microphone set	184-185
midrange speaker	177
mini oven	5
mini rocker switch	215
mist fan	10
mixing amplifier	183
mole repellent stake	40
mosquito repellent	38
motion sensor	80
motion-sensing mini lamp	64
mouse and rat repellent	39
multimedia boombox	170
multimeter	140-142
multispray	224

N

network connection socket	129
network module	34
nightlight	60
notebook charger, adapter	113

O

oil radiator	30-31
opening sensor	92
orchestral speaker cabinet, accessories	180-182
OTG cable	203
outdoor antenna	109
outdoor timer	130

P

package fixing strap	199
parking assistant	199
party light projector	63
pH tester	139
phone holder for bicycles	72
piezo tweeter	178
pocket radio	172
portable fan heater	22
portable halogen floodlight	79
portable lantern	61
portable multimedia speaker box	170-171
portable radio	172
portable, active speaker cabinet	179
power bank	115
power cable for active sub systems	165
power cable	123
power distributor	124-127
power distributor	128
power meter	131
power supply plug and socket	219
projection clock	108
push button	216

Q

quartz tube heater	23
--------------------------	----

R

radiator thermostat	34
ratchet screwdriver set	156-158
RCA connector	208-209
rear view camera	162
recessed indoor switches and sockets	133
reflex tube	193
remote control for alarm set	92
remote controllable power socket	130
rocker switch	214-215, 217
rodent repellent	38
room thermostat	35
room-temperature sensor	33
rubber rope	199
rust remover spray	224

S

salt crystal lamp, tealight holder	139
sandwich maker	6
screen cleaning spray	225
screwdriver set	156-158

selfie stick	61	telephone connection cable	220
shielded cable	210	telephone plug.....	220
side cutter.....	152	telephone wall socket.....	221
silicone spray.....	224	telephone wire distributor.....	221
siren.....	93	telephone wire extender	221
smart thermostat.....	33	telephone wire.....	220
smoke detector	36	terminal box.....	218
socket converter.....	86	test wire set.....	222
solar garden decoration.....	44-45	toaster	6
solar garden light.....	47-49	tool set	157
solar lamp (figures).....	46	tower fan.....	11
soldering excipient.....	149	trailer connector socket.....	198
soldering gun	148	trailer swivel connector.....	198
soldering iron.....	147	transceiver.....	103
soldering pin	147	travel adapter.....	119
soldering station	146-147	tree shape table decoration	54
soldering tin	149	tweeter pair.....	166
sound absorption sponge	194	tweezer set.....	158
sound technology connector.....	192	type-specific connector	198
spare blade for cutter	151		
speaker box connector	192	U	
speaker cabinet accessories	193	universal holders	200
speaker cabinet corner.....	193	universal remote control.....	111
speaker cabinet handle.....	193		
speaker cable	190	V	
speaker cover fabric	194	video cable	205
speaker grill.....	194	video converter	205
speaker ring	194	voltage converter	195
speakerphone and BT FM modulator.....	162	voltage tester	144
spider repellent.....	38		
spotlight	65	W	
standing fan	12	waffle maker	6
standing garden lamp.....	85	wall clock	108
standing heater	25	wall mount.....	112
starter cable	195	wall speaker.....	183
steam iron	9	wall-mounted heater.....	20-21, 25
stereo headphone.....	187-189	water resistant tea light	55
stereo socket	208-209	waterproof speaker pair	168
subwoofer	165, 174-176	weather station.....	104-106
subwoofer.....	176	wide-range speaker.....	177
suction cap holder.....	200-201	wire stripping tool.....	153
surface-mounted indoor switches and sockets.....	132-133	woofer.....	174-175
surface-mounted outdoor switches and sockets ...	132-133	worklamp.....	73-74
switch module.....	34		
		Z	
T		zone manager, accessories.....	32
table decoration.....	55		
table lamp	58		
table mobile phone holder	201		

0-9			
0315H	132.	7301	137.
0316H	132.	7302	137.
0323H	132.	7303	137.
0325H	132.	7304	137.
0326H	132.	7320	136.
0327H	132.	8PK-101-2	148.
0328H	132.	8PK-313B	155.
0329H	132.	8PK-366N-G	148.
0330H	132.	8PK-371D	154.
0534S	133.	8PK-8100	156.
0535S	133.	8PK-CT005	155.
0708S	133.	8PK-MA003	159.
0716S	133.	8PK-MA006	159.
0760S	131.	90212	198.
0795S	129.	90304	199.
1.500211	119.	90410	199.
1PK-036S	153.	90458	199.
1PK-037S	153.	90519	195.
1PK-052AS	152.	90533	195.
1PK-055S	153.	90557	197.
1PK-067AS	152.	90571	195.
22031	133.	90595	197.
22041	133.	90618	197.
22061	133.	90717	199.
22081	133.	90762	198.
22111	133.	90779	198.
22121	133.	90786	199.
22131	133.	908-T301	158.
22141	133.	91110	197.
22151	133.	91769	199.
22161	133.	91998	196.
22181	133.	93220	197.
3274H	133.	93848	199.
3275H	133.	94531	197.
3276H	133.	94586	197.
3277H	133.	94807	139.
400.000.103	82.	94838	196.
400.000.104	82.	9560H	132.
400.000.107	84.	9567H	132.
400.000.107/1	84.	9568H	132.
400.000.108	83.	9850H	132.
400.000.110	84.	9851H	132.
400.000.110/1	84.	9852H	132.
400.000.111	84.	9853H	132.
400.001.108	83.	9854H	132.
400.001.112	84.	9855H	132.
400.002.111	84.		
400.003.107	84.	A	
400.003.107/1	84.	A 3	206.
400.004.101	83.	A 3-10	206.
400.004.101/1	83.	A 3-1M	207.
400.010.105	83.	A 3-3	206.
400.010.106	83.	A 3-5	206.
400.010.116	85.	A 4	206.
400.010.117	85.	A 4-3	206.
400.011.103	82.	A 49	206.
400.011.107	83.	A 49-10	206.
400.011.107/1	83.	A 49-1M	207.
400.012.105	83.	A 49-5	206.
400.012.106	83.	A 51	207.
400.013.107	83.	A 51-1M	207.
400.013.107/1	83.	A 51-5	207.
400.020.116	85.	A 54-2.5M	207.
400.020.117	85.	A 54-5	207.
400.021.104	82.	A 65	207.
400.030.103	82.	A 70FC-1,5	206.
400.030.104	82.	AC 02/CH	119.
400.041.103	82.	AC 02/IT	119.
400.041.104	82.	AC 02/UK	119.
400.050.102	82.	AC 02/US	119.
400.113.114	85.	AC 03	119.
400.113.115	85.	AC 04/4	119.
400.123.114	85.	AC 05	119.
400.123.115	85.	AC 16	209.
400.213.115	84.	AC 16M	207.
400.223.115	84.	AC 17	209.
5031H	133.	AC 18	209.
5200H	133.	AC 19	209.
5202H	133.	AC 1A	218.
5221H	133.	AC 1D	218.
5229H	133.	AC 2A	218.
5232H	133.	AC 2D	218.
5233H	133.	AC 4	209.
5PK-101-2T	148.	AC 6	209.
5PK-366N-T	148.	AC 9	209.
6909H	81.	ADT 40	166.
6914H	81.	AERO 100/400	225.
6915H	81.	AF 18/E14	88.
6916H	78.	AF 18/E27	88.
6921H	81.	AF 28/E14	88.
6948H	81.	AF 28/E27	88.
6982H	81.	AF 28/GU10	88.
6PK-230C	154.	AF 3R12	118.
6PK-230PA	154.	AF 3R12	118.
6PK-301H	154.	AF 42/E14	88.
7098H	81.	AF 42/E27	88.
7300	137.	AF 42/GU10	88.
		AF 52/E27	88.
		AF 6	153.
		AF 6LR61	118.
		AF 6R61	118.
		AF 7	154.
		AF 70/E27	88.
		AF AG0	118.
		AF AG1	118.
		AF AG10	118.
		AF AG12	118.
		AF AG13	118.
		AF AG3	118.
		AF AG4	118.
		AF AG5	118.
		AF AG8	118.
		AF CR1220	118.
		AF CR123	118.
		AF CR1620	118.
		AF CR2	118.
		AF CR2016	118.
		AF CR2025	118.
		AF CR2032	118.
		AF CR2430	118.
		AF CR2450	118.
		AF LR03	118.
		AF LR1	118.
		AF LR14	118.
		AF LR20	118.
		AF LR23A	118.
		AF LR27A	118.
		AF LR6	118.
		AF M18/E14	88.
		AF M18/E27	88.
		AF M28/E14	88.
		AF M28/E27	88.
		AF M42/E14	88.
		AF M42/E27	88.
		AF R03	118.
		AF R14	118.
		AF R20	118.
		AF R50 18/E14	88.
		AF R50 28/E14	88.
		AF R50 42/E14	88.
		AF R6	118.
		AF R63 18/E27	88.
		AF R63 28/E27	88.
		AF R63 42/E27	88.
		AHX 1620/BK	165.
		AHX 2030/BK	165.
		AIR 20	16.
		AIR 20/S	16.
		AIR 30	16.
		AIR 30/S	16.
		AK 01	217.
		AK 11	217.
		AK 12	217.
		AK 61	217.
		AKV 01	217.
		AKV 02	217.
		AKV 11	217.
		AKV 12	217.
		AKV 62	217.
		ALC 4/BK	222.
		ALC 4/RD	222.
		AM 500	93.
		AM 503	93.
		AM 552	93.
		AP 17	166.
		ARZ 081	177.
		ASP-8	109.
		ASP-88T	109.
		ASP-8S	109.
		ATC928WIFI	32.
		ATF600	32.
		ATF800	33.
		AWC 30T	108.
		B	
		BA 1/BK	145.
		BA 1/RD	145.
		BA 2/BK	145.
		BA 2/RD	145.
		BD 4/BK	145.
		BD 4/RD	145.
		BD 5G/BK	145.
		BD 5G/RD	145.
		BDR	34.
		BF 52B	218.
		BF 52L	218.
		BF 53L	218.
		BH 036	219.
		BH 2AA	219.
		BH 2AAA	219.
		BH AA	219.
		BH AAA	219.
		BK 087	168.
		BK 100	168.
		BK 130	168.
		BK 165	168.
		BS 10	164.
		BS 10/A	164.

BS 12.....	164.	DC311EP2.....	99.	ET 1103.....	218.
BT 1650.....	170.	DC313E.....	99.	ET 3.....	144.
BT 2400.....	171.	DC313EP2.....	99.	EV 100/S.....	14.
BT 2800/BL.....	171.	DC915EG.....	99.	EV 100/T.....	14.
BT 2800/GR.....	171.	DE 101464.....	158.	EVZ 100/H.....	14.
BT MAX.....	170.	DE 101467.....	157.	EVZ 100/S.....	14.
BTCL 400.....	107.	DE 101471.....	157.	EVZ 100/T.....	14.
BTHP 2000/BK.....	187.	DE 101483.....	157.	F	
BTHP 3000.....	187.	DE 101484.....	157.	F 803C.....	213.
BTRC 10.....	163.	DE 101489.....	157.	F1 A.....	218.
BV 10.....	71.	DE 101505.....	156.	F1,25 A.....	218.
BV 11.....	71.	DE 101551.....	157.	F1,6 A.....	218.
BV 13.....	72.	DE 305822.....	156.	F10 A.....	218.
BV 14/RD.....	71.	DECO 2.....	55.	F100 MA.....	218.
BV 14/WH.....	71.	DECO 3.....	55.	F16 A.....	218.
BV 15.....	72.	DECO 5.....	55.	F2 A.....	218.
BVF 16.....	71.	DECO 7.....	55.	F2,5 A.....	218.
C		DFL 02.....	69.	F250 MA.....	218.
CBT 200.....	54.	DHM 10L.....	15.	F3,15 A.....	218.
CBT 320.....	54.	DHM 18L.....	15.	F315 MA.....	218.
CD 2/GOLD.....	51.	DHM 250.....	16.	F4 A.....	218.
CD 2/GX.....	51.	DHM 700.....	16.	F5 A.....	218.
CD 2/RED.....	51.	DL 210L.....	62.	F500 MA.....	218.
CD 2/SILVER.....	51.	DL 27.....	63.	F6,3 A.....	218.
CD 2/SX.....	51.	DL 3/27RGB.....	63.	F8 A.....	218.
CD 2/WX.....	51.	DL 6BT.....	62.	FB 2 LED/BL.....	72.
CD 6/WH.....	51.	DL 80L.....	62.	FB 2 LED/YE.....	72.
CDB 2/WH.....	51.	DL IP 2.....	63.	FC 10.....	144.
CDF 1/WH.....	55.	DL MSC.....	63.	FC 20.....	144.
CDF 1/WW.....	55.	DIA 12W.....	57.	FF 1.....	213.
CDG 1/GR.....	51.	DLC 5M.....	57.	FF 1/PRO.....	213.
CDG 1/OR.....	51.	DLF 400/WH.....	56.	FF 10S.....	213.
CDG 1/RD.....	51.	DLF 400/WW.....	56.	FF 13.....	213.
CDG 1/T.....	51.	DLF 600/WH.....	56.	FF 14.....	213.
CDG 1/YE.....	51.	DLF 600/WW.....	56.	FF 15.....	213.
CDR 3/M.....	50.	DLFJ 200/WH.....	57.	FF 18.....	213.
CDW 10.....	50.	DLFJ 200/WW.....	57.	FF 19.....	213.
CDW 3.....	50.	DLI 200/WH.....	56.	FF 21.....	213.
CDW 4.....	50.	DLI 200/WW.....	56.	FF 4.....	213.
CDX 1.....	51.	DLI 40/WH.....	56.	FHP 1200.....	31.
CES 3.....	183.	DLI 40/WW.....	56.	FHP 1200/A.....	31.
CHR 5.....	221.	DM 4070.....	143.	FHP 1200/G.....	31.
CHR 6.....	221.	DO-16.....	129.	FHP 1200/S.....	31.
CHR 7.....	221.	DOF-16.....	136.	FK 1.....	29.
CHR 8.....	221.	DP 01.....	98.	FK 1/0.....	29.
CL 16L.....	66.	DP 011.....	98.	FK 11.....	22.
CL 2L.....	66.	DP 012.....	98.	FK 12.....	22.
CL 36L.....	66.	DP 02.....	98.	FK 13/2000.....	27.
CL 4+1L.....	66.	DP 10.....	178.	FK 15.....	26.
CL 5CL.....	61.	DP 35.....	178.	FK 15/T.....	26.
CL 7L/GR.....	61.	DPH 1416.....	178.	FK 19 TURBO.....	27.
CL 7L/RD.....	61.	DPV 24.....	97.	FK 21.....	26.
CL 7L/YE.....	61.	DPV 25.....	96.	FK 21/T.....	26.
CM 2500AA.....	116.	DPV 25B.....	96.	FK 23.....	26.
CMT707A1011.....	35.	DPV 25K.....	96.	FK 23/T.....	26.
CMT727D1016.....	35.	DRS 10-5/BK.....	223.	FK 24.....	23.
CMW 15.....	50.	DRS 10-5/BL.....	223.	FK 24/T.....	26.
CP-080E.....	153.	DRS 10-5/RD.....	223.	FK 26.....	23.
CP-312B.....	153.	DRS 15-7.5/BK.....	223.	FK 27.....	24.
CP-5018N.....	153.	DRS 20-10/BK.....	223.	FK 28.....	22.
CT 100/2,5.....	221.	DRS 2-1/BK.....	223.	FK 30.....	22.
CT 100/2,5/B.....	221.	DRS 2-1/BL.....	223.	FK 31.....	22.
CT 150/3,5.....	221.	DRS 2-1/RD.....	223.	FK 33.....	28.
CT 150/3,5/B.....	221.	DRS 2-1/WH.....	223.	FK 34.....	28.
CT 200/3,5.....	221.	DRS 4-2/BK.....	223.	FK 35/BK.....	27.
CT 200/3,5/B.....	221.	DRS 4-2/BL.....	223.	FK 37/BL.....	29.
CT 250/4,8.....	221.	DRS 4-2/RD.....	223.	FK 37/GY.....	29.
CT 250/4,8/B.....	221.	DRS 4-2/WH.....	223.	FK 37/RD.....	29.
CT 300/4,8.....	221.	DRS 6-3/BK.....	223.	FK 37/T.....	29.
CT 300/4,8/B.....	221.	DRS 6-3/BL.....	223.	FKC 900.....	24.
CT 400/4,8.....	221.	DRS 6-3/RD.....	223.	FKC 901.....	24.
CT 400/4,8/B.....	221.	DRS 6-3/WH.....	223.	FKF 2000 LCD.....	20.
CT 650/8,8.....	221.	DT 20.....	177.	FKF 2000 LED.....	20.
CX 404.....	167.	DT 5.....	177.	FKF 2000B LCD.....	21.
CX 504.....	167.	DT 6.....	177.	FKF 2000D LCD.....	21.
CX 604.....	167.	DT90A1008.....	35.	FKF 2500 LCD.....	20.
CX 695.....	167.	DTA HIFI.....	204.	FKK 02.....	18.
CSH 1.....	158.	DTF 12.....	177.	FKK 05.....	18.
D		DTS.....	33.	FKK 06.....	19.
D 6.....	102.	DVR FHD1/BK.....	162.	FKK 08.....	17.
DB 0520DC.....	102.	E		FKK 09.....	18.
DB 0525DC.....	102.	E14/E27.....	86.	FKK 2000.....	19.
DB 1010C.....	101.	E14/GU10.....	86.	FKM 400.....	28.
DB 102AC.....	100.	E27/E14.....	86.	FKO 11/BK.....	30.
DB 103AC.....	100.	E27/GU10.....	86.	FKO 11/T.....	30.
DB 108.....	101.	ELITE-4 E14 3000K/HL 4380L.....	88.	FKO 9/BK.....	30.
DB 128.....	101.	ELITE-4 E14 4200K/HL 4380L.....	88.	FKOS 11.....	30.
DB 1510C.....	101.	ELITE-4 E27 3000K/HL 4380L.....	88.	FKOS 13.....	30.
DB 201AC.....	100.	ELITE-6 E14 3000K / E14.....	88.	FKOS 7.....	30.
DB 202AC.....	100.	ELITE-6 E14 4200K / E14.....	88.	FKOS 9.....	30.
DB 228.....	101.	EM 03.....	131.	FKT 22CM.....	26.
DB 442.....	100.	EP 1.....	189.	FKT 24CM.....	26.
DBP 01.....	101.	EP 10.....	189.	FKT 42CM.....	26.
DC 1CS.....	219.	EP 2.....	189.	FKT 44CM.....	26.
DC 1K.....	219.	EP 8/BL.....	189.	FL 10 LED.....	77.
DC 2CS.....	219.	EP 8/P.....	189.	FL 120/T.....	80.
DC311E.....	99.	EPM 1.....	187.	FL 150/BK.....	79.
		ET 1102.....	218.	FL 150/WH.....	79.

FL 20 LED	77.	HCW 22	105.	HT 203	193.
FL 400/T	80.	HCW 23	105.	HT 2340	194.
FL 500/BK	79.	HCW 24	104.	HT 2340/2	194.
FL 500/WH	79.	HD 1,5	204.	HT 304	193.
FLB 10 LED	77.	HD 3	204.	HT 305	193.
FLB 10 LED/YE	77.	HD A1	204.	HT 3123	193.
FLB 20 LED	77.	HD A2	204.	HT 35	194.
FLB 20 LED/YE	77.	HDC 3500	109.	HT 35/30M	194.
FLH 150/YE	79.	HDS 1	204.	HT 400	193.
FLH 500/YE	79.	HDS 2	204.	HT 401	193.
FLP 150/BK	79.	HDS 4,5	204.	HT 402	193.
FLP 150/WH	79.	HG AP 13	7.	HT 410	193.
FLP 500/BK	79.	HG BM 12	7.	HT 510	193.
FLP 500/WH	79.	HG FM 10	8.	HT 600	193.
FLP 6 SOLAR	78.	HG FMZ 10	8.	HT 601	193.
FLS 1/500	80.	HG GS 19	6.	HT 70/BK	194.
FLS 2/500	80.	HG HSZ 17	9.	HT 70/GR	194.
FLST 10	77.	HG KM 17	7.	HT 801	186.
FLST 20	77.	HG KP 01	6.	HT 900	182.
FMBT 22	162.	HG KV 06	4.	HT 901	182.
FMBT 24	162.	HG KV 06/K	4.	HV 211A	191.
FMBT 30	163.	HG KV 06/S	4.	HV 228	191.
FMBT 34	163.	HG M 08	8.	HV 316A	191.
FMT 20	163.	HG MS 09	5.	HV 328	191.
FMT 32	163.	HG PM 09	8.	HV 621	169.
FMT 34	163.	HG SZ 02	6.	HV 623	169.
FOL 3	52.	HG V 15	9.	HVP 28	176.
FONIX-6 3000K / GU5.3	88.	HG VF 03	5.	HVS 14	169., 191.
FONIX-6 4200K / GU5.3	88.	HG VF 04	5.	HW-229B	158.
FP 1230/VDE	147.	HJR 10-15	121.		
FP 30/VDE	147.	HJR 10-25/1,0	120.	I	
FP 60/VDE	147.	HJR 10-30	120.	IK 230	37.
FP 80/VDE	147.	HJR 10-50	120.	IK 240	37.
FPH 4	147.	HJR 24-30	121.	IKK 1	37.
FPH 6	147.	HJR 3-10	121.	IN 25101	39.
FPH 7	147.	HJR 3-20	121.	IN 25105	39.
FS 1	212.	HJR 4-25	121.	IN 25111	39.
FS 14	212.	HJR 4-40	121.	IN 25130	40.
FS 15	212.	HJR 4-50	121.	IN 25151	39.
FS 18	212.	HJRF 10-30/1,5	134.	IN 25241	38.
FS 19	212.	HJRF 24-30	134.	IN 25261	38.
FS 1C	212.	HJRF 4-25	134.	IN 25266	38.
FS 2	212.	HJRF 4-40/1,5	134.	IN 26106	25.
FS 27	212.	HJRF 4-50/1,5	134.	IN 26145	25.
FS 28	212.	HL043 ORANGE / DONALD	59.	IN 26151	25.
FS 2C	212.	HL045 PINK / BUDDY	59.	IR 110	139.
FS 905	212.	HL046 WHITE / OSCAR	59.	ISO 2	198.
FST 1	212.	HL047 BLUE / BIHTER BL	59.	K	
FST 2	212.	HLM 3W	70.	KAD 17	54.
FW 360/BK	138.	HLP 2 D	60.	KAD 18	54.
FW 360/BL	138.	HLP 2 L	60.	KAD 20 STAR	55.
FW 360/PI	138.	HLP 2 O	60.	KAH 202	193.
FW 360/WH	138.	HLP 2 P	60.	KAH 303	193.
FZ 3	110.	HLP 3W+4L	70.	KFG 7/14M	87.
FZ 42	110.	HLP 4	70.	KFGL 9/14M	87.
FZ 45	110.	HLP 5+4L	70.	KFM 40/27H	87.
FZ 50	110.	HPH 1	188.	KFM 60/27H	87.
FZ 52	110.	HPH 2	188.	KFS 13/14H	87.
FZ 56	109.	HPH 3	188.	KFS 13/14M	87.
G		HPH 38	188.	KFS 13/27H	87.
G 16	194.	HPH 5/BL	189.	KFS 13/27M	87.
G 20	194.	HPH 5/P	189.	KFS 20/27H	87.
G 25	194.	HPH 6/BK	189.	KFS 20/27M	87.
G 30	194.	HPH 6/WH	189.	KFS 25/27H	87.
G 40	194.	HPH 7	188.	KFS 25/27M	87.
GATEWAY RFG100	34.	HPH 98	188.	KFS 5/14M	87.
GB 23/BL	43.	HPH 98SP	188.	KFS 5/27M	87.
GB 23/RD	43.	HPM 1	187.	KFS 9/14H	87.
GB 23/YE	43.	HR92	34.	KFS 9/14M	87.
GB 30/BL	43.	HS 01	94.	KFS 9/27H	87.
GB 30/PK	43.	HS 10	94.	KFS 9/27M	87.
GB 30/YE	43.	HS 11	94.	KFU 11/27M	87.
GK-380B	150.	HS 20	94.	KFU 15/27M	87.
GL 03	67.	HS 21	94.	KFU 7/14M	87.
GL 04N	67.	HS 22/2	94.	KFU 7/27M	87.
GL 48	67.	HS 22/4	94.	KH 3	210.
GL 4L	67.	HS 40	92.	KHS 105A	178.
GL KID	61.	HS 50	92.	KHS 106	178.
GLE 12/WWW	55.	HS 60	91.	KHS 107	178.
GLE 15/WWW	55.	HS 61	92.	KHS 110	178.
GLE 20/WWW	55.	HS 62	92.	KHS 120	178.
GPL 25	54.	HS 63	93.	KHS 311M	178.
GSH 026	112.	HS 64	92.	KHS 342M	178.
GU10/E14	86.	HS 70	91.	KL 0,15	190.
GU10/E27	86.	HS 72	92.	KL 0,35	190.
H		HS 74	92.	KL 0,5	190.
HC 11	106.	HS 75	92.	KL 0,5T	190.
HC 12	106.	HS 800	91.	KL 0,75	190.
HC 13	106.	HSB 120	94.	KL 0,75T	190.
HCKK 03	105.	HSB 120/T	94.	KL 1	190.
HCKK 04	106.	HSK 110	95.	KL 1,5	190.
HCKK 05	105.	HSK 120	95.	KL 1,5T	190.
HCKK 06	105.	HSK 200	95.	KL 1T	190.
HCKK 07	102.	HSK 300	95.	KL 2,5T	190.
HCP 20	108.	HSP 75	148.	KLS 0,15	190.
HCW 20	105.	HSP 75T	148.	KLS 0,35	190.
HCW 21	106.	HT 109	153.	KLS 0,5	190.
		HT 200	193.	KLS 0,5T	190.
		HT 201	193.		

KLS 0,75	190.	MK 02297	225.	NBC 90W	113.
KLS 0,75T	190.	MK 1684	225.	NEEC200	225.
KLS 1	190.	MK K60	224.	NEECTAB2	225.
KLS 1,5	190.	MK K61	224.	NEECTAB4	225.
KLS 1,5T	190.	MK SZ01	224.	NF 120P030	114.
KLS 1T	190.	MK T600	224.	NK 120P100	114.
KLS 2,5T	190.	ML 10 GLOBE	52.	NKL 01	76.
KLS 4T	190.	ML 20/WW	53.	NKL 022	75.
KLS 6T	190.	ML 50/WW	53.	NKL 022F	75.
KN 4	210.	ML 80/WH	53.	NKL 03	76.
KN 6	210.	ML 80/WW	53.	NKL 30	76.
KN 7	210.	MLC 13/HB	53.	NKL 5D	76.
KOF 6	152.	MLC 30/M	53.	NKLA	76.
KOF 7	152.	MLC 30/WH	53.	NKLF	75.
KROF 6	152.	MLC 30/WW	53.	NKLF T5	75.
KROF 8	152.	MO 090563D	225.	NKLL 04	75.
KSD 2,8-0,5/Cu	218.	MO 290206D	224.	NKLL 05	75.
KSD 2,8-0,5/Sn	218.	MO 290303D	224.	NL 120	65.
KSD 4,8-0,5/Cu	218.	MO 90505	224.	NL 120P050	114.
KSD 4,8-0,5/Sn	218.	MO 90508	225.	NLH 1	60.
KSD 6,3-0,8/Cu	218.	MONOBLOK	129.	NLM 1	60.
KSD 6,3-0,8/Sn	218.	MPA 250	183.	NLO 5	60.
KSH 2,8-0,5/Cu	218.	MRPX 2-130	168.	NLTG 1	60.
KSH 2,8-0,5/Sn	218.	MRPX 2-165	168.	NT-305	144.
KSH 4,8-0,5/Cu	218.	MS 8209	140.	NV 03	127.
KSH 4,8-0,5/Sn	218.	MS 8250B	141.	NV 03/BK	127.
KSH 6,3-0,5/Cu	218.	MSW 01	216.	NV 03/WH	127.
KSH 6,3-0,5/Sn	218.	MSW 03	216.	NV 03-3/B	127.
		MSW 11	216.	NV 03-3/W	127.
L		MSW 13	216.	NV 03-3/WH/1,5	127.
LA 3	58.	MTP 10-25	145.	NV 03-5/W	127.
LA 5	58.	MTP 3-12,5	145.	NV 03-5/WH/1,5	127.
LA 6	58.	MTP 5-25	145.	NV 03K	127.
LA 7 BT	58.	MVN 10	185.	NV 03K/BK	126.
LABEL 130	224.	MVN 500	185.	NV 03K/WH	126.
LCDH 01/BK	112.	MVN 700	185.	NV 03K-3/B	126.
LCDH 02/BK	112.	MVN 900	184.	NV 03K-3/G	126.
LCDH 07	112.	MVN 901T	184.	NV 03K-3/W	126.
LCDH 08	112.	MVT 808ACE	144.	NV 03K-3/WH/1,5	126.
LCDH 18	112.	MW 1222-2GS	116.	NV 03K-5/G	126.
LCDH 19	112.	MW 2P100	113.	NV 03K-5/W	126.
LCDH 27	112.	MW 3IP25	114.	NV 03K-5/WH/1,5	126.
LCDH 28	112.	MW 3K10	114.	NV 04	127.
LH 0.5S/14M	86.	MW 3N06	114.	NV 04/WH	127.
LH 1/14M	86.	MW 3R15	114.	NV 04-3/W	127.
LH 300	11.	MW 7H50GS	113.	NV 04K/WH	126.
LH 300/T	11.	MW 8XC2	114.	NV 04K-3/W	126.
LM 001	139.	MX 101	44.	NV 05	127.
LMF 001	139.	MX 102	44.	NV 05/WH	127.
LNL 120	65.	MX 203	45.	NV 05-3/W	127.
LNL 500	65.	MX 459/1	48.	NV 05K/WH	126.
LNL 600	65.	MX 500	45.	NV 05K-3/W	126.
LP 10/M	52.	MX 512/K	45.	NV 06	127.
LP 20/WW	52.	MX 616K	44.	NV 06/BK	127.
LPL 10	52.	MX 616P	44.	NV 06/WH	127.
LPL 30	52.	MX 616S	44.	NV 06-3/B	127.
LTC 01	107.	MX 616T	44.	NV 06-3/W	127.
LTC 02	107.	MX 617	45.	NV 06-3/WH/1,5	127.
LTCR 01	107.	MX 621A	49.	NV 06-5/W	127.
LTN 1/WH	42.	MX 631A	46.	NV 06-5/WH/1,5	127.
LTN 10/GR	43.	MX 632A	46.	NV 06K	127.
LTN 10/RD	43.	MX 632C	46.	NV 06K/BK	126.
LTN 10/WH	43.	MX 633A	46.	NV 06K/WH	126.
LTN 11/BL	43.	MX 636	46.	NV 06K-3/B	126.
LTN 11/PL	43.	MX 638	46.	NV 06K-3/G	126.
LTN 11/YE	43.	MX 715D	48.	NV 06K-3/W	126.
LTN 2/BK	42.	MX 720	49.	NV 06K-3/WH/1,5	126.
LTN 2/WH	42.	MX 720/4	49.	NV 06K-5/G	126.
LTN 3/BK	42.	MX 737	49.	NV 06K-5/W	126.
LTN 3/WH	42.	MX 760	49.	NV 06K-5/WH/1,5	126.
LTN 4/BK	42.	MX 801	45.	NV 1/WH	128.
LTN 6	41.	MX 802/4	47.	NV 10	129.
LTN 7	42.	MX 803	49.	NV 10T	129.
LTN 9	42.	MX 804/4	47.	NV 13/WH	128.
		MX 805/4	47.	NV 14/WH	127.
		MX 807/4	47.	NV 14-3/W	127.
M		MX 811/4	47.	NV 17/WH	126.
M 11	186.	MX 812	48.	NV 18/WH	127.
M 266	143.	MX 819/1	49.	NV 18-3/W	127.
M 300AA/2	49.	MX 826	48.	NV 2-10/G	122.
M 300AAA/2	49.	MX 838/OR	48.	NV 2-10/O	122.
M 41	186.	MX 838/P	48.	NV 2-10/W	122.
M 600AA/2	49.	MX 838/WH	48.	NV 22	128.
M 61	186.	MY 64	141.	NV 2-20/O	122.
M 700AAA	116.	MZ 2	144.	NV 2-20/W	122.
M 71	186.	MZ 3	144.	NV 22-90	128.
M 8	186.			NV 2-3/W	122.
MA-019	159.	N		NV 23/WH	128.
MA-022	159.	N 1/VDE	123.	NV 2-30/O	122.
MAS 830	142.	N 10-3/1,0	123.	NV 2-30/W	122.
MC 625/BK	210.	N 10-5/1,0	123.	NV 24/WH	128.
MC 9	116.	N 11/VDE	123.	NV 2-5/G	122.
MFL 02	68.	N 1-2WH/VDE	123.	NV 2-5/O	122.
MFL 023	68.	N 2/VDE	123.	NV 2-5/W	122.
MFL 03	68.	N 2K-2/WH	123.	NV 3-10/OR	134.
MFL 04	68.	N 5	123.	NV 3-10/WH	134.
MFL 05	68.	N 7	123.	NV 3-20/OR	134.
MFL 06	68.	N 8-3/1,5	123.	NV 3-20/OR/1,5	134.
MFL 10	68.	N 8-5/1,5	123.	NV 3-30/OR	134.
MK 02296	225.				

NV 3-30/OR/1,5	134.	PLR 01	69.	SA 032	196.
NV 3-5/WH	134.	PLR 02	69.	SA 034	196.
NV 5-10/G	122.	PLR 03	69.	SA 037	200.
NV 5-20/G	122.	PLR 04	69.	SA 038	200.
NV 5-30/G	122.	PLUS-4 3000K / GU10	88.	SA 040	206.
NV 7-10/GY	122.	PLUS-4 4200K / GU10	88.	SA 041	203.
NV 7-20/GY	122.	PLUS-6 3000K / GU10	88.	SA 044	203.
NV 7-30/GY	122.	PLUS-6 4200K / GU10	88.	SA 045	196.
NV FP 2	129, 135.	PLZ 1/BK	67.	SA 047	201.
NV MS 2+6	124.	PLZ 1/WH	67.	SA 047/WH	201.
NV MS 5	124.	PNL 1	64.	SA 050/GY	203.
NVF 03	136.	PNL 2	64.	SA 050/M	203.
NVF 03/WH	135.	PNL 3/WH	64.	SA 051	203.
NVF 03-3/WH	135.	PNL 4	64.	SA 052	200.
NVF 03-5/WH	135.	PNL HRT	64.	SA 053	200.
NVF 03K	136.	PNL RND	64.	SA 054	162.
NVF 03K/WH	135.	PNV 04K/WH	125.	SA 055	201.
NVF 03K-3/WH	135.	PNV 06K/WH	125.	SA 057	199.
NVF 03K-5/WH	135.	PNV 06K-90/WH	125.	SA 058	201.
NVF 04	136.	PNV 08K/WH	125.	SA 059	72.
NVF 04/WH	135.	PNV 10K/WH	125.	SA 083	163.
NVF 04-3/WH	135.	PNVF 04K/WH	135.	SA 1000USB	113, 203.
NVF 04K/WH	135.	PNVF 04K-5/WH	135.	SA 2100USB	113, 203.
NVF 04K-3/WH	135.	PP 1	148.	SA 333	169.
NVF 05	136.	PP 1T	148.	SA-ANTCS 001	197.
NVF 05/WH	135.	PREMIER-10 3000K/HL 4310L	88.	SA-ANTCS 002	197.
NVF 05-3/WH	135.	PREMIER-10 4200K/HL 4310L	88.	SA-ANTCS 004	197.
NVF 05K/WH	135.	PREMIER-10 6400K/HL 4310L	88.	SA-ANTCS 008	197.
NVF 05K-3/WH	135.	PREMIER-12 3000K/HL 4312L	88.	SA-ANTCS 014	197
NVF 06	136.	PREMIER-12 4200K/HL 4312L	88.	SA-FISO 022	198.
NVF 06/WH	135.	PREMIER-15 3000K	88.	SA-FISO 027	198.
NVF 06-3/WH	135.	PREMIER-15 4200K	88.	SA-FISO 028	198.
NVF 06-5/WH	135.	PREMIER-8 3000K/HL 4308L	88.	SA-FISO 031	198.
NVF 06K	136.	PREMIER-8 4200K/HL 4308L	88.	SA-FISO 032	198.
NVF 06K/WH	135.	PREMIER-8 6400K/HL 4308L	88.	SA-HSZBGY 004	194.
NVF 06K-3/WH	135.	PVR 35	14.	SA-HSZBGY 008	194.
NVF 06K-5/WH	135.	PVR 40	14.	SAI 1000W	195.
NVF 16/WH	136.	PVR 45	14.	SAI 600W	195.
NVF 17/WH	135.	PVR 50	14.	SAIP 300W	195.
NVF 2-16/WH	136.	R		SAL 10A/BK	173.
NVF 22-90	136.	RCA 11	208.	SAL 20 ACTIVE	173.
NVK 03K/WH	125.	RCA 11G	208.	SAL 2610S	173.
NVK 03K-3/WH/1,5	125.	RCA 11MF	208.	SAT CABLE	211.
NVK 06K/WH	125.	RCA 12	208.	SBF 2025	165.
NVK 06K-3/WH/1,5	125.	RCA 12G	208.	SBV 2020	175.
NVK 1/WH	129.	RCA 21	208.	SBV 2020/4	175.
NVK 3/WH	129.	RCA 22	208.	SBV 2530	175.
NVKF 1/WH	129, 137.	RC-OPEN4	95.	SBX 1010/BK	174.
NVKF 3/WH	137.	RC-OPEN4/P	95.	SBX 1320/BK	174.
NVO 03K/BK	124.	RF 1	212.	SBX 1620/BK	174.
NVO 03K-5/BK	124.	RF 10	212.	SBX 2030/BK	174.
NVO 05K/BK	124.	RF 3	212.	SBX 2530/BK	174.
NVO 05K-5/BK	124.	RF 5	212.	SBX 3040/BK	174.
NVP 03K/WH	124.	RFK 1	212.	SBX 4060/BK	174.
NVP 06K/WH	124.	RFK 5	212.	SF 41	12.
NVT 04K/WH	124.	RG 58	211.	SFI 45	12.
NVT 06K/WH	124.	RG 6-32/BK	211.	SFM 42/BK	10.
NVT 1/WH	129.	RG 6-32/WH	211.	SFM 42/SL	10.
NVTF 04K/WH	135.	RG 6U/BK	210.	SFP 40	12.
NVTF 06K/WH	135.	RG 6U/WH	210.	SFS 40	12.
NVTF 1/WH	137.	RG 6U-500/WH	210.	SFS 40	12.
O		RG59+NAP	211.	SG 109	148.
OC 01	108.	RINGER	221.	SG 109T	148.
OC 02	108.	RPC 2B	172.	SG 13	194.
OH 1	189.	RPC 2BX	172.	SG 16	194.
OL 100	69.	RPR 2B	172.	SG 20	194.
OL 5 LED	69.	RPR 4B	172.	SG 25	194.
OLOF 6	152.	RRT 3B	172.	SG 30	194.
OLOF 7	152.	RS 50	223.	SK 2M	208.
OPK 2/1,5	207.	RS 50/10	223.	SK 3M	208.
P		RS 52/10	223.	SK 4	209.
PA 12	182.	RT 12120	115.	SK 4EB	209.
PA-101	153.	RT 1213	115.	SK 4K	208.
PAB 20A	179.	RT 1245E	115.	SK 4M	209.
PAB 25A	179.	RT 1270ES	115.	SK 4MK	208.
PAX 225A	181.	RT 6120	115.	SK 4P	208.
PAX 225P	181.	RT 645	115.	SK 5	208.
PAX 25A	181.	RT5400T2	109.	SKL 12	139.
PAX 25PRO	180.	S		SKL 610	139.
PAX 25PRO/A	180.	S 23	192.	SKM 57	139.
PAX 40PRO	180.	S 24	192.	SKN 10	177.
PAX 40PRO/A	180.	S 25K	192.	SKN 13	177.
PB 2500	115.	S 29-5C	213.	SKN 16	177.
PB 2600/BL	115.	S 29-6C	213.	SL 106	192.
PB 2600/SL	115.	S 42	213.	SL 2ER	192.
PB 4AA/BK	115.	S 5	209.	SL 4ER	192.
PB 4AA/BL	115.	S 6TSP/WH	210.	SL 5	192.
PB 4AA/WH	115.	S 6TSV/BK	210.	SL 5ER	192.
PHT 01	139.	S 6TSV/WH	210.	SL 6MG	192.
PIR 04/WH	80.	S 98G	145.	SLF 52/B	61.
PIR 06/WH	80.	SA 001	169.	SLF 52/F	61.
PL 15+1L	74.	SA 020	196.	SLL 500	65.
PL 20	74.	SA 022	196.	SLL 600	65.
PL 9L	74.	SA 023	196.	SM-336H	155.
PLF 12	70.	SA 024	201.	SMA 005	150.
PLF 19	70.	SA 025	201.	SMA 005T	150.
PLF 7	70.	SA 030	169.	SMA 006	150.
				SMA 007	150.
				SMA 008	150.
				SMA 009	150.

SMA 050	147.	SWC 30	108.	TW 3-6	155.
SMA 051	146.	SWCU 1/17	149.	TW 4-6	155.
SMA 055	147.	SZ 1-1	93.	TWF 81	11.
SMA 056	147.	SZ 3-1	93.	TWFR 79	11.
SMA 057	147.	SZ 3-6	93.	TWFR 80	11.
SMA 058	147.	SZK 10	151.	U	
SMA 059	147.	SZK 20	151.	UH 10	38.
SMA 067T	150.	SZK 21	151.	ULTRA-4 3000K / HL 4360L	88.
SMA 2101	143.	SZK 30	151.	ULTRA-4 4200K / HL 4360L	88.
SMA 5051T	147.	SZKB 2	151.	ULTRA-6 3000K	88.
SMA 64	141.	SZKS 01	151.	ULTRA-6 4200K	88.
SMA 68	141.	T		URC 1	111.
SMA 830	142.	T 5-10/WH	220.	URC 10	111.
SMA 92	142.	T 5-15/WH	220.	URC 20	111.
SMC 33	195.	T 5-20/WH	220.	URC 2000AC/SL	111.
SN 10	219.	T 5-5/WH	220.	URC 21	111.
SN 10M	219.	T 6-3/WH	220.	URC 22	111.
SN 12	219.	T1 A	218.	URC 23	111.
SN 12M	219.	T10 A	218.	URC 24T	111.
SN 2	219.	T2 A	218.	USB A/MICRO-1	202.
SNL 300/T	65.	T2,5 A	218.	USB A/MINI-1	202.
SNL 320	65.	T3,15 A	218.	USB LED/BK	69.
SP 01/BK	216.	T4 A	218.	USB LED/WH	69.
SP 01/RD	216.	T5 A	218.	USBP A/MICRO-1	202.
SP 02/BK	216.	T500 MA	218.	USBP A/MICRO-3	202.
SP 02/RD	216.	T6,3 A	218.	USR 4	38.
SP 10/BK	216.	T6360A1079	35.	V	
SP 10/RD	216.	T87	33.	V 1	206.
SP 12/GR	216.	TA 32	109.	V 50S	205.
SP 12/RD	216.	TC 6LR61	117.	V 50SG	205.
SPA 2030	176.	TC CR 123A	117.	V 52S	205.
SPA 2530	176.	TC CR2016	117.	V 56	205.
SPA 3040	176.	TC CR2025	117.	V 81-3	205.
SPA 4050	176.	TC CR2032	117.	VB 2200	161.
SPK 850	192.	TC LR03	117.	VB 3000	161.
SPK 860	192.	TC LR03/6	117.	VB 6000	161.
SPK 900	192.	TC LR1	117.	VB X100	160.
SRP 1010	175.	TC LR14	117.	VB X700	160.
SRP 1315	175.	TC LR20	117.	VBC 100/BK	222.
SRP 1620	175.	TC LR23	117.	VBC 100/RD	222.
SRP 2030	175.	TC LR6	117.	VBC 200/BK	222.
SS 110	223.	TC LR6/6	117.	VBC 200/RD	222.
SS 1116/N	198.	TCM 10000D	116.	VBC 30/BK	222.
SS 1116/P	198.	TCM 1100AAA	116.	VBC 30/RD	222.
SS 120	223.	TCM 2300AA/RTU	116.	VBC 7/BK	222.
SS 1-4317/G	198.	TCM 2700AA	116.	VBC 7/RD	222.
SS 210	223.	TCM 280-9	116.	VC 20-2	206.
SS 220	223.	TCM 4500C	116.	VC 3D	205.
SS 30A	198.	TCM 800AAA/RTU	116.	VC 3D-3	205.
SS 310	223.	TD 01	131.	VC 830L	142.
SS 320	223.	TD 02	131.	VCC 1/BK	222.
SS 40A	198.	TD 022	131.	VCC 1/RD	222.
SS 410	223.	TD 10	130.	VCC 2/BK	222.
SS 420	223.	TDf 5	128.	VCC 2/RD	222.
SS 510	223.	TF 23	13.	VCC 210	222.
SS 520	223.	TF 31	13.	VCC 3/BK	222.
SS 60A	198.	TFS 30	13.	VCC 3/RD	222.
SS 80A	198.	TG 3	131.	VD 22	144.
SS 910	223.	TG 4	131.	VK 01	40.
SS 920	223.	TH 1	130.	VKS 02	40.
ST 1/BK	215.	TH 111	130.	VKS 03	40.
ST 1/RD	215.	TH 113	130.	VKS 04	40.
ST 10/BK	215.	TK 1/BK	220.	W	
ST 10/RD	215.	TK 1/WH	220.	W 330	224.
ST 21	215.	TK 2/WH	220.	W 340	224.
ST 22	215.	TK 4	220.	WAS 2	183.
ST 302	215.	TK 460	224.	WDB 112	102.
ST 303	215.	TLKR T41	103.	WDB 113	100.
ST 304	215.	TLKR T50	103.	WDB 121	102.
ST 305	215.	TLKR T80 EXTREME	103.	WL 06	74.
ST 315	215.	TPF-26	128.	WL 07	74.
ST 316	215.	TPF-26/GR	128.	WL 27A	73.
STV 01	214.	TS 12	220.	WL 3W+7L	73.
STV 02	214.	TS 13	220.	WL 5-8	74.
STV 03	214.	TS 14	220.	WL 60H	73.
STV 04	214.	TS 15/WH	221.	WRX 310	166.
STV 05	214.	TS 16-2/WH	221.	WRX 313	166.
STV 06	214.	TS 16-3/WH	221.	WRX 316	166.
STV 07	214.	TS 17-2	221.	WRX 469	166.
STV 08	214.	TS 1909	213.	WS 11	196.
STV 101	214.	TS 1910	213.	WS 20	196.
STV 11	214.	TS 1911	213.	WS 2300	139.
STV 12	214.	TS 1913	213.	X	
STV 15	214.	TS 1M/WH	221.	XB-1012/A/T	165.
SUPER 10	224.	TS 2M/WH	221.	XB-8/A	164.
SVS 6011	205.	TS 500	149.	XC100D-HU	36,90.
SW 0,5/250	149.	TS 51	220.	XC100-HU	36,90.
SW 0,8/100	149.	TS 52/BK	220.	XC70-HU	36,90.
SW 0,8/250	149.	TS 52/WH	220.	XH100-HU	36,90.
SW 0,8/500	149.	TS 560	149.	XS100-HU	36,90.
SW 1,5/250	149.	TS 570	149.	XS100T-HU	36,90.
SW 1,5/500	149.	TS 580	149.	Y	
SW 1/100	149.	TS MD 5	130.	Y87RFC2074	33.
SW 1/250	149.	TSP 1909	213.	YD 78	177.
SW 1/500	149.	TSP 1910	213.	Z	
SW 2/100	149.	TSP 1911	213.	Z 2	93.
SW 2/250	149.	TSP 1913	213.		
SW 2/500	149.	TT 1-1	220.		
SW 3/250	149.	TT 18-2	220.		

800 Watt output	3 stages	glass	stereo speaker	eco-friendly technology
8 cups	swing louver	for IOS devices	Jack plug	no liquid mercury
1 l water tank	timer	for Android devices	power supply	carbon dioxide saving
1,7 l water tank	night mode	downloadable from App Store	BT connection	wireless
rotatable in 360°	remote control included	downloadable from Google Play	MP3	100 meters range (m)
9 l volume	oscillation	against mosquitos	USB connection	phone call function
timer	oscillation	against rodents	SD card	angle of view: 120°
2 slices	adjustable high	against insects	E14 socket	2 in 1: alarm + chime
non stick	head angle	against ants	laser light	18m length of wire
1 l glass tank	dehumidifying capacity	against mosquitos	SMD LED technology	120 volume
15.000/minute revolutions/minute	scope	against rodents	brightness	passive infrared motion sensor
5 speed levels	relative humidity	against moles	white LED	adjustable volume
turbo function	ambient temperature	range	CREE LED technology	operating frequency
measuring range	dual power supply	indoor	metal	battery service life
tempered glass	dehumidifying capacity	battery operated	Krypton bulb +70%	ultra thin
high precision	with adapter	automatically switches on/off	dynamo charge	vandal proof
10 user memory	no CO emission	automatically switches on/off	speed focus	dust/water protection
weight	no mounting needed	color changing LED	no mounting needed	melodies
cold air function	timer	operated by solar panel	USB cable	adjustable volume
steam function	ionisator	DIP LED technology	COB LED technology	alarm clock
self cleaning	IPX4 protection	number of LEDs	magnetic	extra visible
humidifier function	IPX1 protection	outdoor and indoor	color temperature	AM frequency range
temperature display of premise	output stages	brightness	temperature range	FM frequency range

 size of display	 iPad	 screen diagonal	 2 way	 length of cable
 mains adapter	 navigation system	 radio data system	 paper cone	 on/off switch
 child protection	 MP3 player	 image resolution	 dual cone	 metal connection
 large size	 MP4 player	 pixels	 waterproof	 metal housing
 continuously moving seconds indicator	 camera	 dual USB charger	 load	 XLR connection
 glass front panel	 USB connection	 voltage meter	 cross-section	 LED can be switched on/off
 diameter	 12 V DC	 fast charger	 volume control	 universal
 max. volume ... dB	 polarity	 6 types of sound	 1 way	 built-in microphone
 built-in amplifier	 eco-friendly	 phone charger	 3 channel audio system	 laptop
 capable of receiving digital TV signals	 EuP standard	 large display	 microSD card	 size of earphone
 turbo cooling	 universal	 polypropylene cone	 magnetic shielding	 connection plug
 turbo heating	 memory	 diameter (mm)	 for professional use	 safe for kids
 smart sleep mode	 measuring range	 impregnated paper cone	 cooling liquid	 for all ages
 on-off timer	 for professional use	 speaker grill	 mounting dimensions	 gold plated connectors
 screen diagonal	 negotiable spirit level	 impedance	 excellent sound quality	 oxygen free copper wire
 carrying capacity	 gold plated connectors	 2 channels	 bass reflex	 mounting dimensions
 automatic switch	 LED display	 black kevlar cone	 carrying capacity	 stereo
 output	 temperature control	 PEI cone	 high quality	 3 shield
 amperage	 230 V ~ ... W	 3 way	 for professional use	 impedance
 load	 made in Europe	 rubber verge	 with 110 V transformer	 diameter
 tablet	 3 in 1	 aluminium cast	 metal	
 mobile phone	 1000 V	 4 way	 connection plug	



SOMOGYI ELEKTRONIC®



Somogyi Elektronik Ltd. H-9027 Győr, 3. Gesztenyefa str.
Telephone: +36 96 512-512 Fax: +36 96 512-522
E-mail: somogyi@somogyi.hu Web: www.somogyi.hu
Competent Court of Registration: Győr-Moson-Sopron
County Court of Registration
Company Registry No.: 08-09-002824

We reserve the right to make technical alterations, and products may differ from those shown on the photos.

